

*Surface heating and cooling system  
for ceilings, walls and floors*

aquatherm **black**





## Table of contents

- 5 History
- 7 About aquatherm
- 9 Product types
- 15 Details & special features
- 29 Areas of application & installation
- 191 Quality assurance
- 195 Planning & design
- 207 Performance values
- 217 Regulation
- 226 Acoustics
- 237 References
- 247 Warranty
- 251 Transport & storage
- 255 Article lists





## History —

- 1973 Foundation of the aquatherm company by Gerhard Rosenberg
- 1981 Development of the first polypropylene pipework system, green becomes aquatherm's trademark
- 1991 Foundation of the Radeberg branch
- 1996 First certification of the quality management system according to ISO 9001
- 1997 Foundation of sales company in Italy
- 1999 Development of the fusiotherm® fibre composite pipe
- 2001 aquatherm is active in more than 50 export markets
- 2002 Market launch of aquatherm blue
- 2005 Market launch of aquatherm red and aquatherm black
- 2010 System extension of pipe dimensions up to max. ø 630 mm
- 2010 Handover of the management to Christof, Dirk and Maik Rosenberg
- 2012 First-time certification of the environmental management system according to ISO 14001
- 2012 Market launch of fusiolen® PP-RP material
- 2013 First-time certification of the energy management system according to ISO 50001
- 2017 Opening of the new pipe extrusion facility - one of the most modern of it's kind worldwide
- 2018 Opening of the new injection moulding
- 2018 Foundation of sales company in England
- 2019 Expansion of industrial prefabrication
- 2021 Participation in the sales company aquatherm ibérica s.l.
- 2022 Opening of the aquatherm campus
- 2023 aquatherm celebrates its 50th anniversary
- 2024 Jan Kriedel takes over the management with Maik Rosenberg





## AQUATHERM BLACK

### Revolution since 1973

It all began with a vision. On 17 August 1973, Gerhard Rosenberg founded aquatherm GmbH - based in the garage and basement of his private home. The ambitious goal?

To revolutionise the market as a pipe manufacturer. This vision gave rise to aquatherm, the world's leading manufacturer of plastic pipework systems made of polypropylene for plant engineering and building services.

Areas of application include surface heating and cooling systems, heating system construction, chemical transport, refrigeration technology, shipbuilding, drinking water applications and sprinkler systems.

Thanks to their special material properties, aquatherm products are characterised by their wide range of applications. They can be used in all areas of new installation, repair and refurbishment.

In order to guarantee the worldwide availability of its products and offer local service, aquatherm works closely with long-standing partners in 70 countries around the globe. The company employs around 500 people in Germany, Italy and England.

Production takes place exclusively at the German sites in Attendorn (headquarters) and Ennest. Our customers worldwide can therefore rely on innovative and safe PP-R piping systems of the highest quality "100% Made in Germany".

Today, the family business is managed by Maik Rosenberg, son of aquatherm founder Gerhard Rosenberg, and Jan Kriedel.





## aquatherm black product types \_\_

aquatherm black is a multi-award-winning surface heating and cooling system. Versatile in use, manufactured in a compact grid design and equipped with future-proof technology - these are some of the key features of the aquatherm black product family. What makes it special: It can be installed in the ceiling as well as in walls and floors and is suitable for both heating and cooling.

aquatherm black is very energy efficient. The system can be connected to any heating source and offers a direct contribution to the heating transition in these uncertain times. It fully utilises its advantages in combination with low-temperature systems such as heat pumps. Building owners and architects are delighted with the Flexible areas of application and the associated design freedom: whether as a cooling ceiling in offices, as underfloor heating in new buildings, or as wall or ceiling heating in renovated old buildings - the possibilities are almost unlimited. After all, the panel heating and cooling elements can be installed in drywall construction, plastered ceilings, walls or suspended coffered ceilings and are invisible afterwards.

### Features \_\_

The tried and tested system is constantly being optimised. aquatherm black sets new standards in terms of both installation and energy efficiency. Thanks to its improved installation process, this innovative system is more user-friendly than ever before.

This innovative solution is the perfect choice for anyone looking for a sustainable, cost-effective and high-performance radiant heating and cooling system. aquatherm black has been developed to offer unrivalled energy efficiency, a better indoor climate and a higher level of comfort.

### Material \_\_

Thanks to its unique polypropylene design, this system is significantly more sustainable than conventional metal-based solutions. It also saves you money in the long term.

aquatherm black is highly efficient and allows you to reduce your energy consumption while still enjoying a comfortable temperature in your living or working space. Upgrade your premises with aquatherm black and experience the difference in energy efficiency, comfort and sustainability.







## aquatherm black product types \_\_

### **Quality \_\_**

Quality is a top priority at aquatherm. This is not only reflected in the national and international test marks, but above all in the satisfaction of aquatherm customers, installers and planners.

You can find an overview of our ISO certificates here:

[Certificates](#)

### **Warranty \_\_**

Due to the high product quality, aquatherm offers a 10-year warranty on all heating and cooling grids instead of the 2 years applicable under German law. The extended warranty period is covered by a comprehensive insurance policy from a leading insurance company in our industry. Details can be found in the Warranty section of the catalogue.

### **Price advantage \_\_**

aquatherm offers you sophisticated systems with high-quality products at an attractive price/performance ratio.

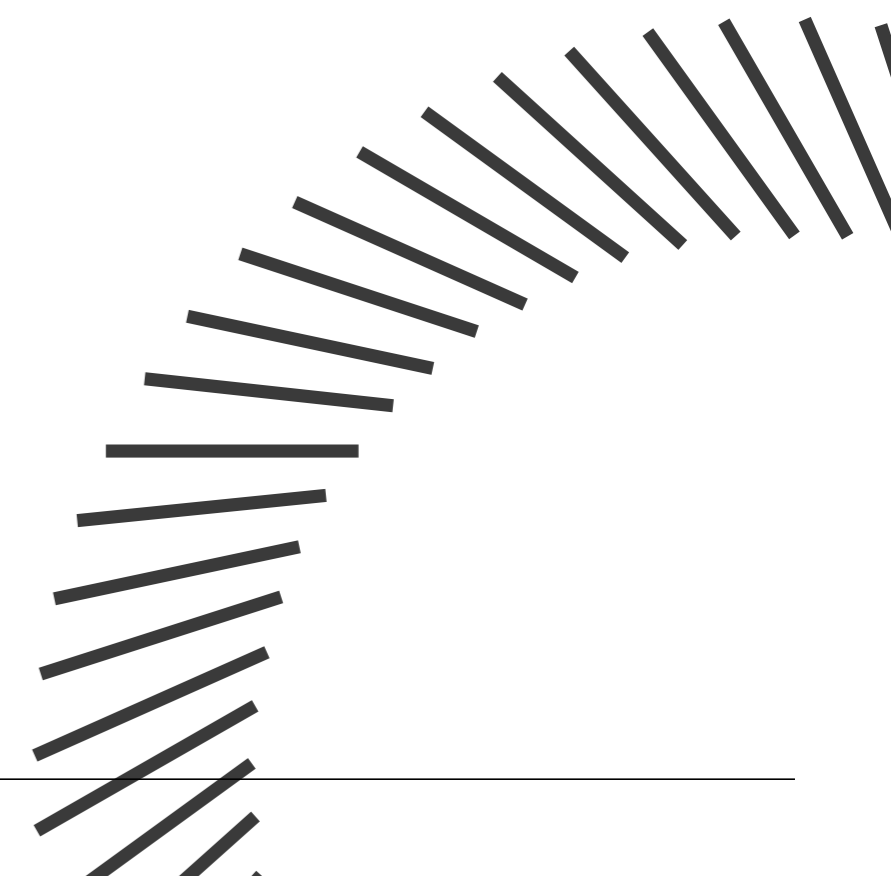





## aquatherm black – Overview

Width (m)      Length (m)

### aquatherm black energy grid

one-sided push-fit connection,  
45° left / right  
Connection type 43

0,24-0,60

0,60-2,00



### aquatherm black energy grid

alternating push-fit connection,  
45° bottom left / top right  
Connection type 44

0,24-0,60

0,60-2,00



### aquatherm black heating and cooling grid

one-sided welding connection,  
left / right  
Connection type 45

0,24-0,60

0,60-2,00



### aquatherm black energy grid

one-sided push-fit connection,  
left / right  
Connection type 46

0,24-0,60

0,60-2,00

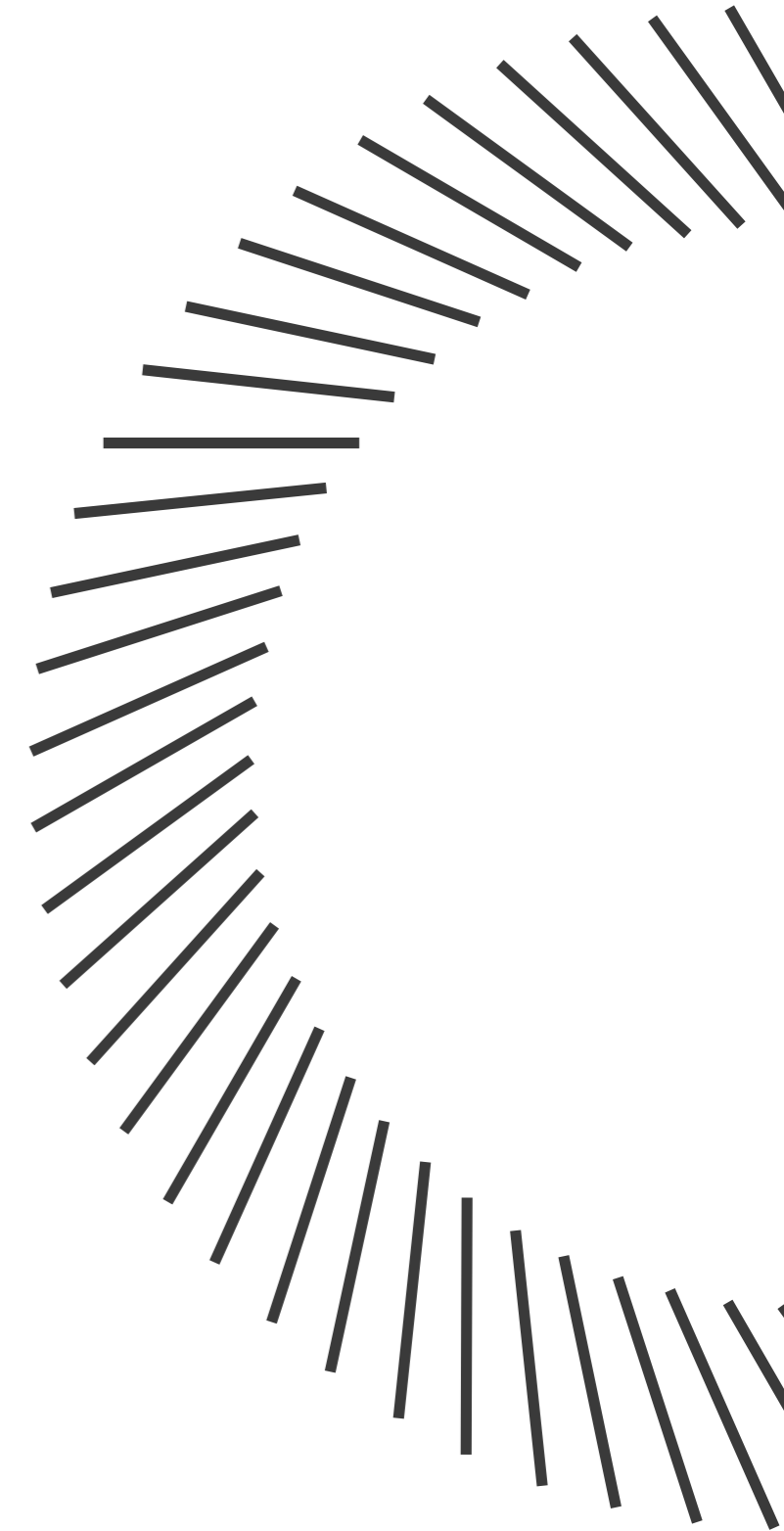





**aquatherm black**  
**Details &**  
**special features**

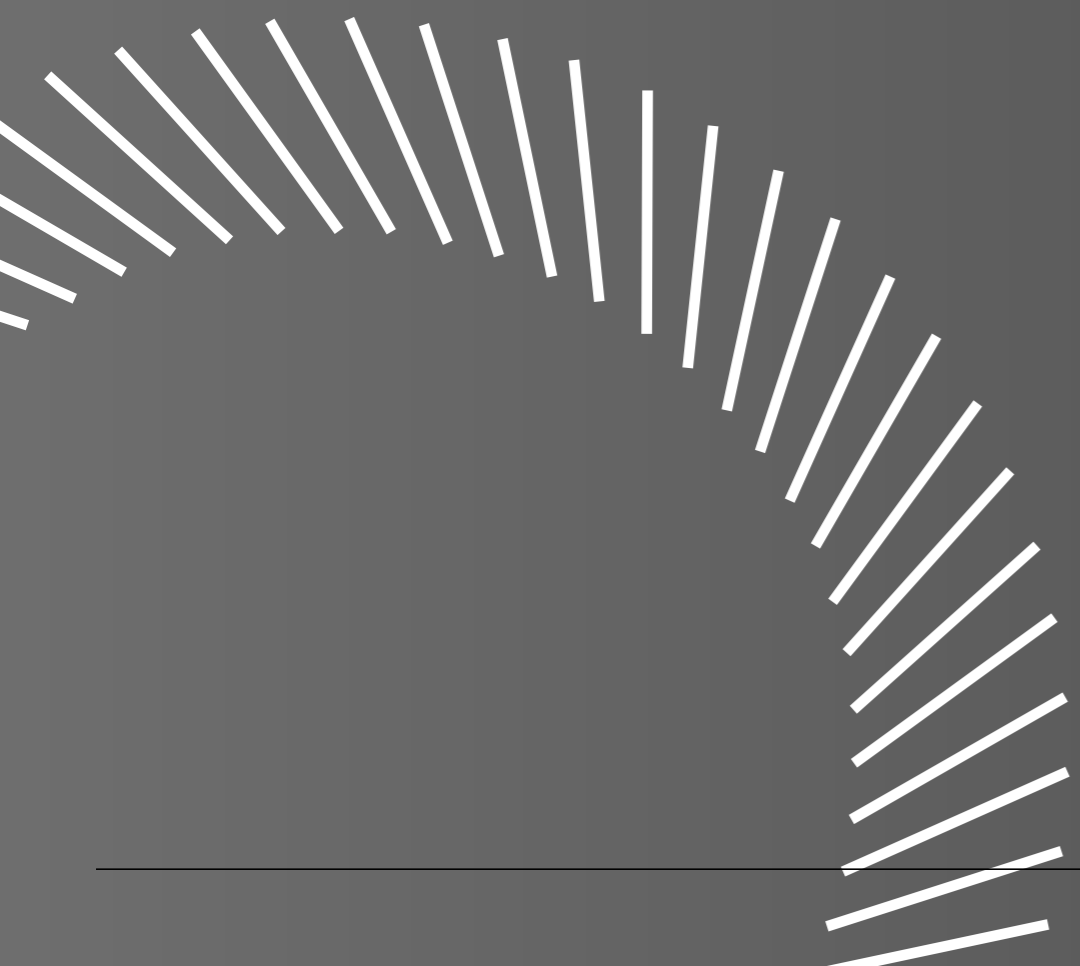





## Advantages at a glance \_\_

### Variable

aquatherm black can be used flexibly thanks to its modular design. In ceilings, walls and floors, it is compatible with all standard installation methods and finishing variants. The dimensions of the grids cover a wide range and facilitate the design and planning of a building - a system for all requirements, from detached houses to commercial properties.

### Simple

No special tools or complex components are required for the aquatherm black grid. Simple technology, tried and tested for decades, that's all you need.

### Fast

The installation of aquatherm black energy grids with push-fit/clamp technology is completely tool-free. No time-consuming preparatory work or planning is required for installation. The time advantage for the realisation of projects is enormous.

### Efficient

Low flow temperatures, optimised control technology, coordinated system components and low pressure losses result in the high energy efficiency of the aquatherm black system.

### Sustainable

aquatherm black grids are made from polypropylene. Throughout its entire life cycle, from raw material extraction to recycling at the end of its useful life, aquatherm black has a significant impact on the environment emitting less CO<sub>2</sub> than comparable metal-based systems. This can significantly improve the ecological footprint.

## Comfort and vitality \_\_

### In the cold season

The use of aquatherm black surface heating and cooling systems leads to a reduction in energy costs and therefore makes a significant contribution to the heat transition, regardless of the heat source used. With aquatherm black, you can start saving immediately and plan the changeover of the heat source flexibly at the best possible time according to your personal needs.

### In the warm season

Are you using a heat pump that can also cool? With aquatherm black grids, you can cool your rooms efficiently thanks to the low flow temperatures - without installing additional and costly air conditioning systems. This keeps your building pleasantly cool even at high outside temperatures.

The silent and uniform cooling of the rooms, without any draughts, leads to a pleasant room climate and improves well-being.





## Energy efficiency and heat transition readiness

Surface heating and cooling systems are more energy-efficient than conventional heating systems. This is because these systems use radiant heat to warm or cool rooms, as opposed to convective heat generated by conventional radiators.

### Lower flow temperatures

aquatherm black grids work with lower flow temperatures than conventional heating systems. While conventional radiators usually require water temperatures of 60-80°C, aquatherm black only requires temperatures between 25-30°C. The low flow temperatures have a direct impact on energy requirements and therefore energy costs.

### Even heat distribution

aquatherm black grids distribute the heat evenly throughout the room so that there are no hot or cold spots. The familiar temperature differences when using conventional radiators and the associated unnecessary energy losses are therefore a thing of the past.

### Efficient use of renewable energies

aquatherm black grids can be efficiently connected to heat pumps and combined with renewable energies, e.g. photovoltaics.

Heat pumps work more efficiently when they are operated with low flow temperatures.

Surface heating and cooling systems allow the heat pump to operate at low temperatures, which improves the COP (coefficient of performance) of the heat pump.

By combining surface heating and cooling systems with renewable energies, energy consumption can be further reduced and the ecological footprint improved.

### Cooling options

Surface heating and cooling systems from aquatherm not only offer heating options, but can also be used for cooling.

As with heating, aquatherm black also demonstrates its advantages when it comes to cooling. Uniform cooling without unpleasant air movement or noise makes the classic air conditioning system look old. The increase in comfort coupled with efficient cooling performance is unrivalled.

To summarise, radiant heating and cooling systems are more energy efficient than conventional heating systems due to their lower flow temperatures, even heat distribution, reduced heat losses, efficient use of renewable energy and cooling options. Utilising these systems reduces energy consumption, increases comfort and reduces negative environmental impacts.

## Independence from the heating system

Decarbonisation of the heat supply and the unclear regulatory outlook are increasingly unsettling consumers. aquatherm black panel heating and cooling systems offer solutions and stability regardless of political decisions.

By using aquatherm black grids, everyone can make a contribution to the heat transition today, regardless of the future heat source.

### aquatherm black for every heat source

aquatherm black can be used with any existing heating source. The refurbishment work for future requirements can be spread over a longer period of time. The heating system can be replaced at the best possible time without time pressure.

### aquatherm black in an old building

Renovating an old building by removing the radiators and installing underfloor heating is hardly economical. aquatherm black grids offer decisive advantages: Simple installation of wall and ceiling heating instead of costly installation of underfloor heating. Refurbishment can be carried out during ongoing operation. The modular design and quick and easy installation reduce the amount of refurbishment work required.

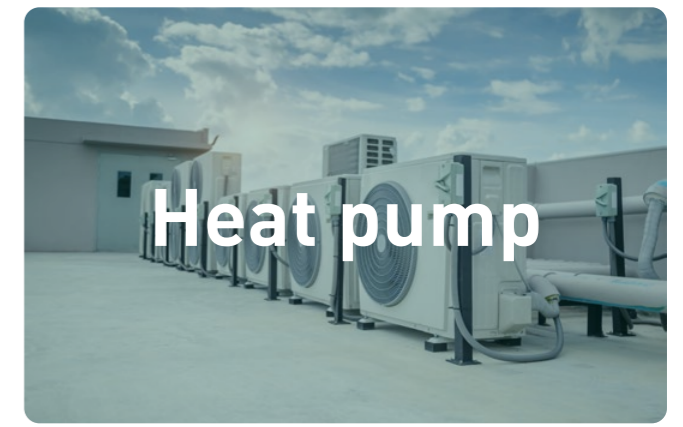





## Technology

### High variability: One system for many applications

High temperatures reduce work efficiency and drive up the cost of cooling. Uncomfortable room air, draughts and the background noise of conventional air conditioning also reduce work performance.

The technology of the aquatherm black surface heating and cooling systems creates a pleasant room climate without annoying draughts. With various control components including automatic switching from heating to cooling mode, the system is perfectly complemented to fulfil your individual requirements.

And the best thing about it? aquatherm black not only impresses with its performance, but also with its smart dimensions. Thanks to its low height, it can be installed seamlessly under plaster or drywall elements. The installation height of just 24.5 mm, including manifold, fixing rail and connections, makes installation easy. The rectangular distributors/collectors are arranged alternately, which enables simple connection using the Tichelmann method. Whether in suspended ceilings on metal cassette elements or drywall panels made of plasterboard or fibre plaster - aquatherm black integrates perfectly. It can even be embedded in wall and ceiling plaster and in stud walls with plasterboard.

With a weight of only approx. 4.1 kg/m<sup>2</sup> (including water filling), it does not affect the construction of the ceiling elements. For optimum insulation and efficiency, we recommend covering the ceiling elements with at least 30 mm of mineral insulation after installation. Depending on the version, the aquatherm black grids are connected by tool-free plugging or by socket welding the heating elements. The elements are then connected to the cooling or heating water circuit.

aquatherm black sets new standards in terms of climate comfort and energy efficiency. Get the perfect indoor climate in your building and boost your performance!

### Optimum solution for renovation and refurbishment

Discover the innovative mode of action of aquatherm black. By skilfully controlling the surface temperature, just a few degrees below or above the room temperature, aquatherm black unfolds its effect. The exchange of radiation with the ceiling leads to a pleasant change in room temperature while you feel comfortable in your room. The ratio of 2/3 radiation and 1/3 convection ensures optimum overall performance.

The variable size of the modules means that inactive ceiling areas can be combined as required. This means that not all ceiling surfaces need to be fitted with aquatherm black grids, giving you maximum design freedom. Active and inactive surfaces fit together seamlessly without any visible differences. With aquatherm black, you can retrofit your ceiling or extend it at a later date - without any complications or restrictions.

aquatherm black not only creates maximum comfort, but also maximises energy efficiency. The targeted adjustment of the surface temperature and the efficient use of radiant heat save you energy and costs.

### Radiant heat vs. Convection heat

Radiant heat and convection heat are two different methods of heating a building. With radiant heat, the radiant energy is used to heat objects and people directly, while convection heat heats the air in a room, which then circulates and warms the room. Radiant heat offers the following advantages over convection heat in terms of energy efficiency and comfort.

### Energy efficiency:

Radiant heat is generally more energy efficient than convection heat as it heats objects and people directly instead of heating the air. Consequently, less energy is required to maintain the desired temperature in a room. Furthermore, less heat escapes through windows, walls and ceilings.

### Comfort:

Radiant heat offers a more even and comfortable heat distribution than convection heat. This is because radiant heat warms objects and people, which then radiate heat back into the room, creating a more even and comfortable temperature. With convection heat, the warm air rises towards the ceiling, making the lower part of the room colder and creating thermal bridges.

### Health:

Radiant heat is also healthier than convection heat because it does not dry out the air and does not create air currents that can spread dust and allergens. This is particularly important for people with allergies or respiratory diseases.

### Noise:

Radiant heating systems are generally quieter than convection heating systems. Convection heating systems generate loud noises due to the air circulation, especially in systems with forced ventilation.

### Interpretation:

The use of radiant heating systems allows rooms to be designed in a more architecturally appealing way, as they are integrated into ceilings, walls and floors so that they are virtually invisible. Overall, radiant heat is a more energy-efficient and comfortable option for heating a building, especially for people with allergies or respiratory diseases. The advantages of radiant heating described above outweigh the disadvantages of the potentially higher costs.

### Advantages

- Maximum climate comfort
- Silent operation
- No additional dust exposure
- Low installation height
- High degree of architectural design freedom
- High energy efficiency
- Preserving the natural storage capacity of a building





## Material

aquatherm black is made exclusively from fusiolen® PP-R. The physical properties are tailored to the special requirements of the heating and cooling sector. The exceptionally good welding properties offer maximum safety and durability. fusiolen® PP-R is also characterised by its high temperature and pressure resistance. Continuous temperatures of 60° C can be run without any problems. As a rule, aquatherm black is operated at much lower flow temperatures than conventional underfloor heating systems.

In combination with the aquatherm blue pipework system (made of fusiolen® PP-RCT) for air conditioning, heating and plant engineering, aquatherm offers a complete solution for heating and cooling generators.







## aquatherm **Environmental Product Declaration** \_\_\_

### **The key to an ecological construction industry** \_\_\_

Climate change is one of the greatest challenges of our time. Released CO<sub>2</sub> is the main problem: it is released into the atmosphere and therefore increases the greenhouse effect - the earth continues to heat up. Many organisations and companies have recognised the need for action. The idea of sustainability has also arrived in the construction industry, which is responsible for 36% of global energy consumption and

39% of energy and process-related CO<sub>2</sub> emissions. But how do you know how sustainable a product is? Environmental Product Declarations provide answers to this question.

### **What is an EPD?** \_\_\_

An Environmental Product Declaration (EPD) describes the impact of a product or service on the environment. It records the resource consumption and emissions over the entire life cycle of the product - from raw material extraction to disposal - and quantifies and evaluates these. An environmental product declaration therefore offers the opportunity to compare different products with one another.

In the Environmental Product Declaration, the characteristics of a product are identified neutrally and in accordance with internationally recognised standards. A precise methodology in accordance with ISO 14025 and EN 15804 is followed and all values are checked by independent third parties for completeness, plausibility and conformity with standards.

However, the EPD is not a certificate, i.e. requirements are placed on the quality and format of the data, but not on the product quality. For the construction sector, it forms an important basis for the ecological assessment of buildings.

### **What are product category rules?** \_\_\_

Product category rules (PCR) are used to assess functionally similar products in the same way as part of an Environmental Product Declaration. These are a compilation of specific rules, requirements or guidelines according to which products are categorised into groups. Product category rules exist, for example, for thermal insulation materials, windows & doors or building pipework systems.

### **What is a life cycle assessment?** \_\_\_

The aim of a life cycle assessment (LCA) is not only to provide environmentally relevant data on specific products, but also to estimate potential environmental impacts and therefore facilitate decisions in favour of or against a particular product. The basis of the LCA is the life cycle of a product. It consists of various phases: Raw material extraction, material production, use, waste treatment and final disposal. All environmental inputs and outputs are listed. In other words, everything that flows into and out of the product is measured. This can be raw materials or resources, various types of energy, water or emissions to air, soil or water.







What does the **product life cycle** include ? \_\_

A life cycle assessment considers either the entire life cycle of a product or parts of it. A distinction is therefore made between three different approaches to assessing the product life cycle:

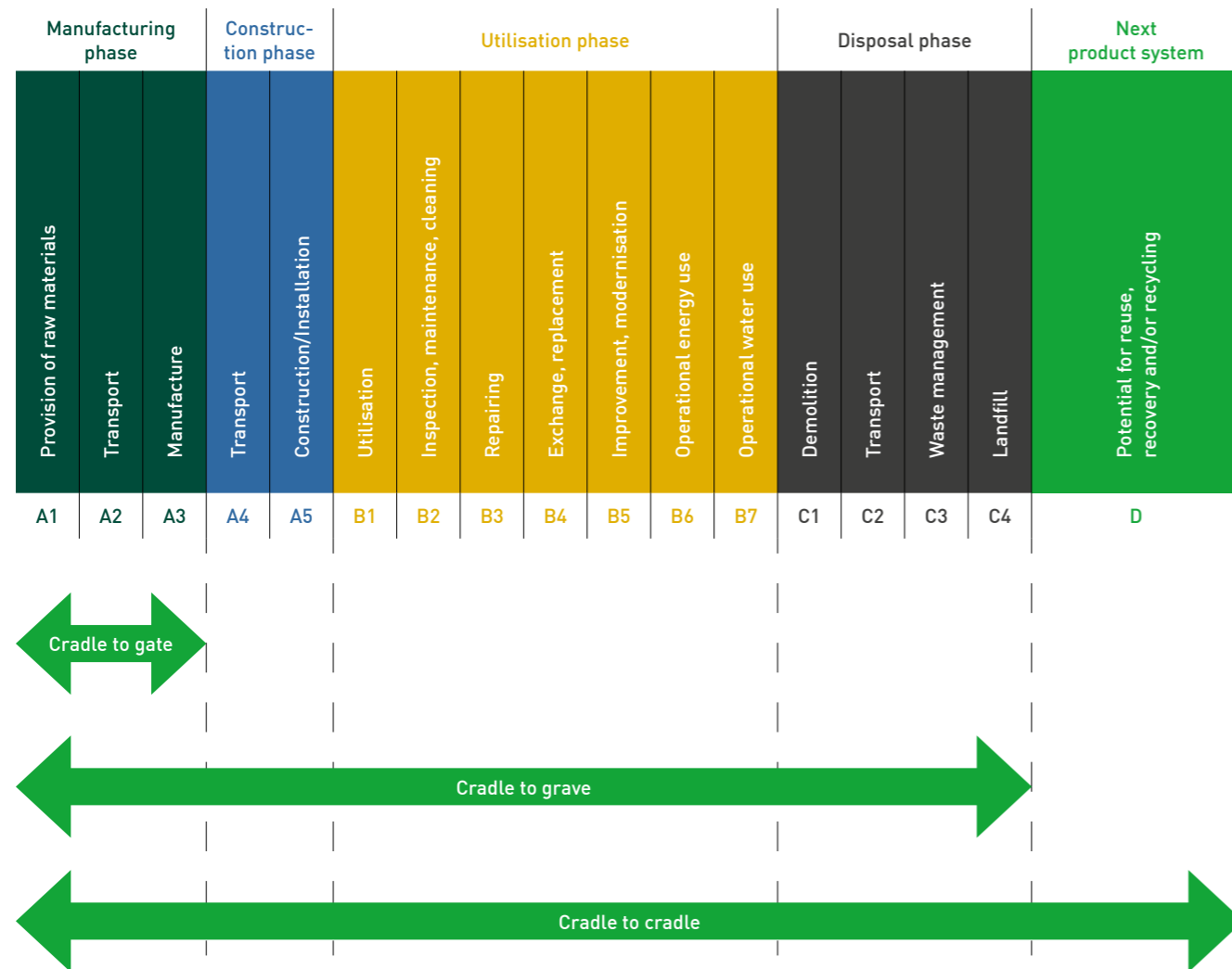

- 1) Cradle to grave / "from the cradle to the grave"
- 2) Cradle to gate / "from the cradle to the gate"
- 3) Cradle to cradle / "from the cradle to the cradle"

What **environmental impact indicators** are there? \_\_

Life cycle assessments provide information on the potential impact of a product (or service) on the environment. EN 15804+A2 prescribes 13 core indicators for environmental impacts to be reported for an Environmental Product Declaration, as well as 6 additional, optional environmental impact indicators.

Core indicators in accordance with EN 15804+A2:

Core indicator	Unit
GWP-total	kg <sub>CO2-Aq</sub>
GWP-fossil	kg <sub>CO2-Aq</sub>
GWP-biogenic	kg <sub>CO2-Aq</sub>
GWP-luluc	kg <sub>CO2-Aq</sub>
ODP	kg CFC11-Äq.
AP	mole <sup>H+</sup> -Äq.
EP-freshwater	kg <sub>PO4-eq</sub>
EP-marine	kg N-Äq.
EP-terrestrial	mole N-Äq.
POCP	kg NMVOC-eq.
ADPE	kg Sb-Äq.
ADPF	MJ
WDP	m <sup>3</sup> world eq. withdrawn

**Legend**  
 GWP = Global warming potential  
 ODP = Depletion potential of the stratospheric ozone layer  
 AP = Acidification potential of soil and water  
 EP = Eutrophication potential  
 POCP = Formation potential for tropospheric ozone  
 ADPE = Potential for the depletion of abiotic resources - non-fossil resources (ADP substances)  
 ADPF = Potential for depletion of abiotic resources - fossil fuels (ADP - fossil fuels)  
 WDP = Water removal potential (user)

Additional impact categories in accordance with EN15804+A2 - optional:

Indicator	Unit
PM	Cases of illness
IR	kBq U235-eq.
ETP-fw	CTUe
HTP-c	CTUh
HTP-nc	CTUh
SQP	-

**Legend**  
 PM = Potential occurrence of diseases due to particulate matter emissions  
 IR = Potential effect of human exposure to U235  
 ETP-fw = Potential toxicity comparison unit for ecosystems  
 HTP-c = Potential toxicity comparison unit for humans (carcinogenic effect)  
 HTP-nc = Potential toxicity comparison unit for humans (non-carcinogenic effect)  
 SQP = Potential soil quality index

How reliable is a **Environmental Product Declaration**? \_\_

Neutral and in accordance with internationally recognised standards: This is how the characteristics of a product are recorded in an environmental product declaration. The precise methodology follows ISO 140253 and EN 158044, and all values are verified by independent third parties. The Environmental Product Declaration is valid for a period of five years. If changes are made to the manufacture of the product during this period, so that major deviations from the previous values are to be expected, a review must be carried out.

What advantages does a **Environmental Product Declaration** offer? \_\_

Environmental Product Declarations enable companies to participate in public tenders, for example, or investors to have their buildings certified according to sustainability systems such as BREEAM, LEED or DGNB. In addition, an Environmental Product Declaration forms the basis for the development and optimisation of sustainable products.

**Environmental Product Declarations** from aquatherm \_\_

Environmental Product Declarations are important - for the construction industry and therefore for us and our customers. That is why we have had our products assessed according to the "cradle to gate" concept.

Our Environmental Product Declarations are available at



for the following product groups:

- aquatherm green/blue S/MF
- aquatherm red S/MF
- aquatherm black
- aquatherm green/blue S/MF (OT)
- aquatherm green/blue S/MF (UV)
- aquatherm green/blue S/MF (ENERGY)





**aquatherm black**  
**Application**  
**& installation**

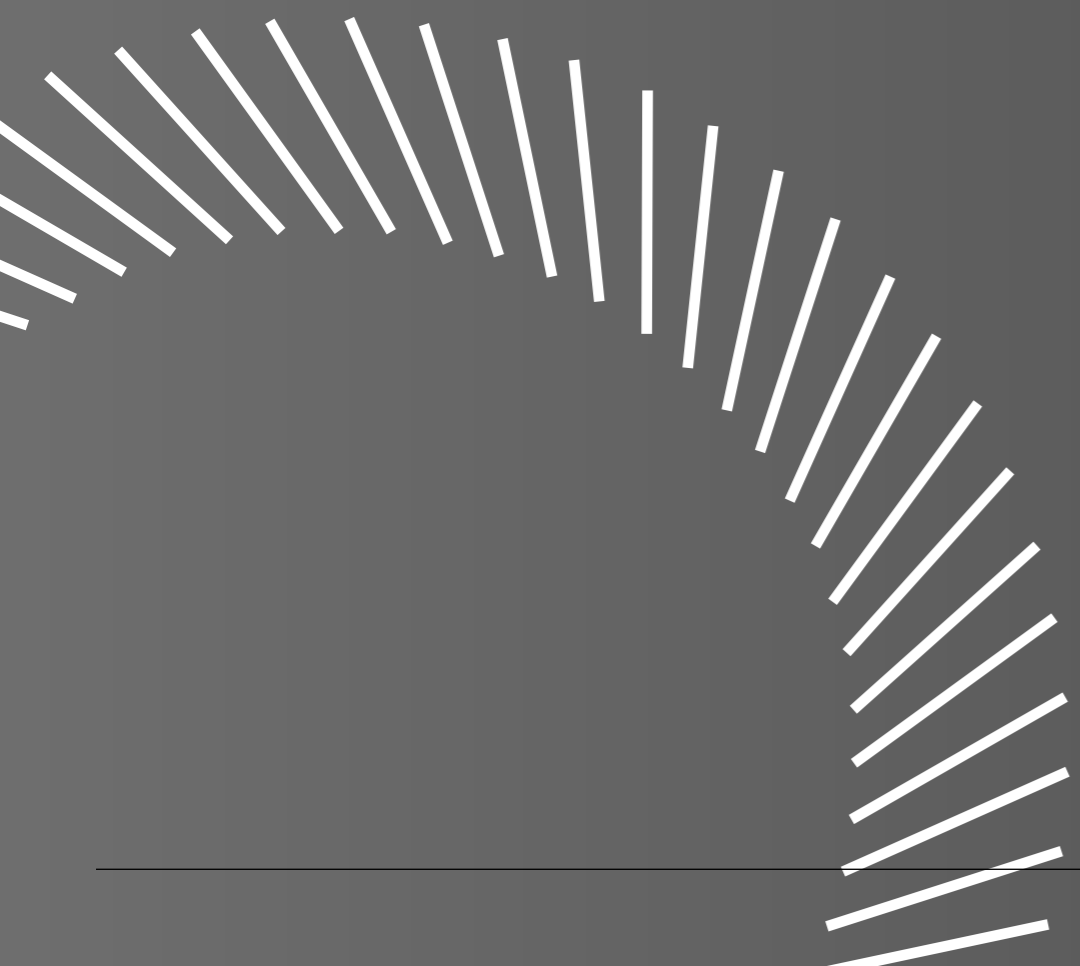





## Convection heat versus radiant heat

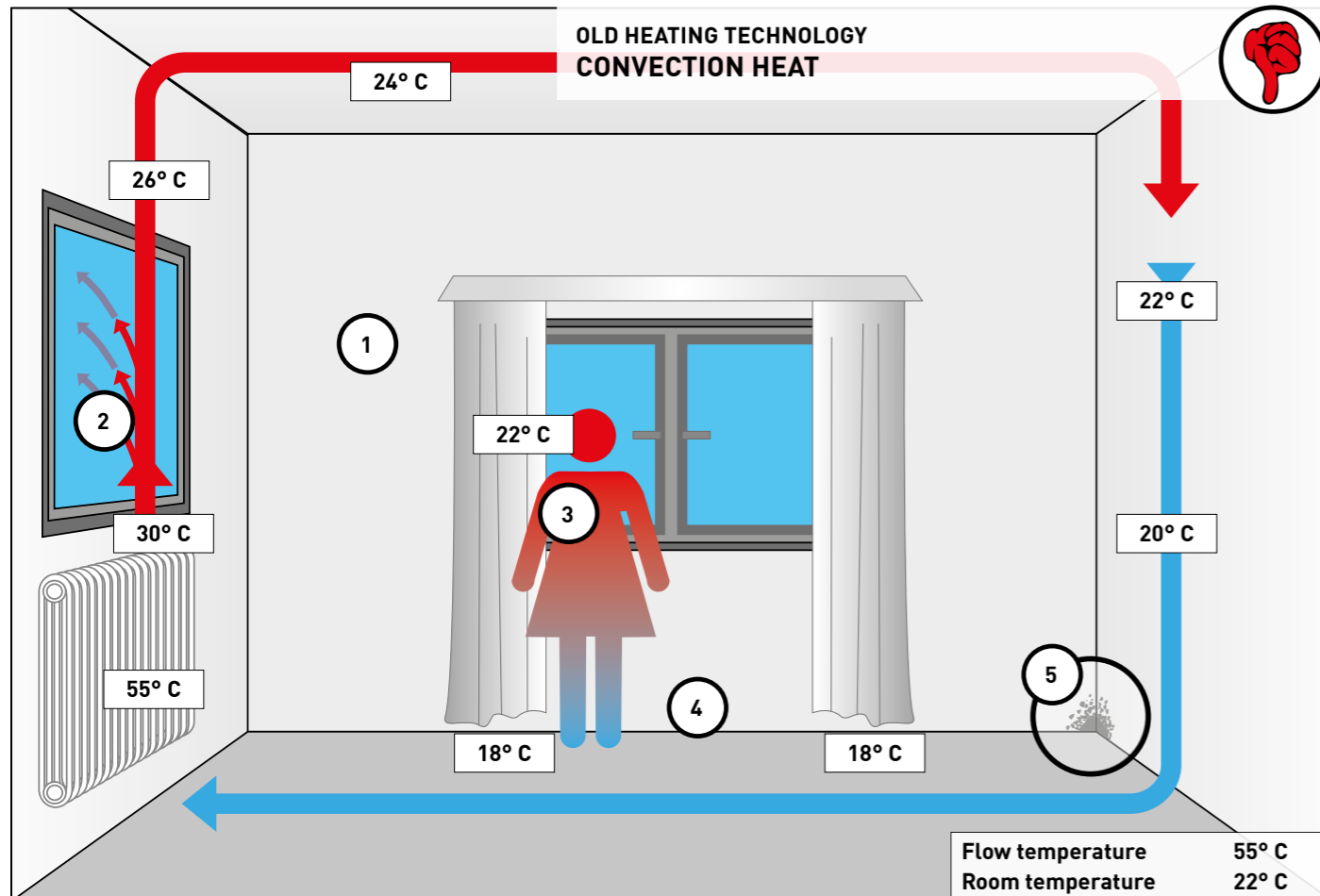

### Convection heating with conventional radiator

- ① **Energy loss 1:**  
To heat a room with air, a high air temperature of at least 22° C is required. Air is a poor heat transfer medium, which is why the energy costs are high.
- ② **Energy loss 2:**  
Even high-quality windows are the weak point of insulation in the house and lead to the greatest energy losses. The air heats the glass and the energy escapes during ventilation.
- ③ **Health hazards:**  
The air movement of the rising heat stirs up dust and microorganisms, which can affect allergy sufferers and sensitive people. An increase in room temperature causes a reduction in humidity, which dries out the mucous membranes. This impairs the natural filter system (nose).
- ④ **Discomfort:**  
As the warm air rises and is mainly located in the upper part of the room, the feet remain cold. This creates a feeling of discomfort. The heating is set to a higher level. The above effects are intensified.
- ⑤ **Mould formation:**  
Cold air passes over the walls, water condenses and creates a breeding ground for mould growth.

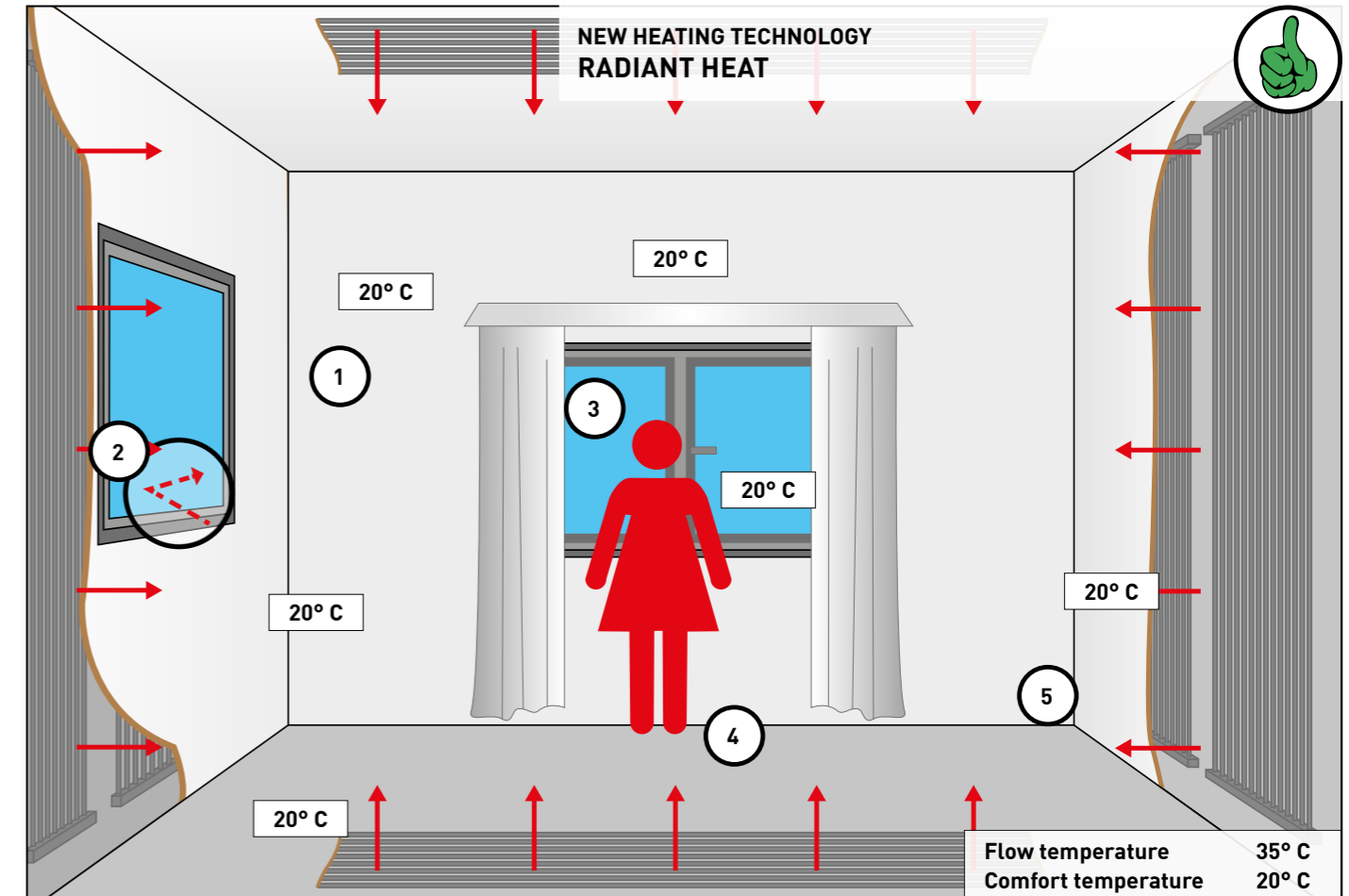

### Radiant heating with new aquatherm black

- ① **Save energy 1:**  
Like the sun, radiant heating first heats all objects and bodies in the room. In the first step, ceilings, walls and floors are heated; the room air follows in the second step. A high air temperature is not necessary with radiant heating. 20° C is perfectly adequate for the room user to feel comfortable.
- ② **Save energy 2:**  
Losses through the window are minimised.
- ③ **Save energy 3:**  
The room air temperature is low. This means that there are no major energy losses even when ventilating. The lower air temperature creates a natural, pleasant climate.
- ④ **Well-being:**  
There are no temperature differences in the room air, as is the case with convection heating, with radiant heat. Your head stays cool and your feet stay warm.
- ⑤ **Dry walls:**  
As the walls are heated directly, there is no condensation and therefore no mould growth.





## Push-in / clamp connection

The innovative aquatherm black energy grid system uses a smart "push-fit / clamp connection" to connect the grids quickly and reliably.

Installation is easy thanks to a Flexible and bendable connection pipe that works with spring band clamps. Place the end of the pipe on the connection piece and push it to the stop with light pressure. Then slide the spring band clamp up to the second stop on the connection piece and release the pre-tension.

Our system not only offers maximum functionality, but also easy handling. The push-fit/clamp connection can be released mechanically. You can use standard hand pliers for spring band clamps to effortlessly remove the connection.

### Time and cost efficiency

The tool-free installation of the aquatherm black energy grid does not require specialised personnel and therefore enables faster and simpler installation. The elimination of time-consuming preparatory work shortens the installation time. The reduction in labour costs leads to lower overall installation costs.

### Flexibility and adaptability

The energy grids can be easily installed and adapted to the specific needs of the room. An efficient and uniform heating and cooling solution can also be realised in complex rooms.

### Faster assembly times - Less labour required

No delays and bottlenecks in the realisation of construction projects due to a lack of qualified personnel. Simple installation procedure and tool-free system enable even less experienced workers to carry out the installation without errors.

Reducing dependence on highly specialised skilled workers and helping to overcome the skills shortage. The simple tool-free installation of panel heating offers a number of advantages in terms of time and cost efficiency, flexibility, labour shortage and quality assurance. Given the current shortage of skilled labour and increased costs in the construction industry, the use of such installation techniques is of great importance. By simplifying the installation process, costs can be reduced, installation times shortened

and high-quality heating and cooling solutions realised. Tool-free installation therefore contributes to the optimisation of construction processes and makes it possible to successfully meet the increased requirements and challenges in the construction industry.

- Permissible continuous operating pressure 4 bar (at max. 60°C)
- Permissible maximum continuous temperature 60°C
- Max. permissible test pressure 6 bar (analogue AQT leak test)

## Installing the push-fit / clamp connection

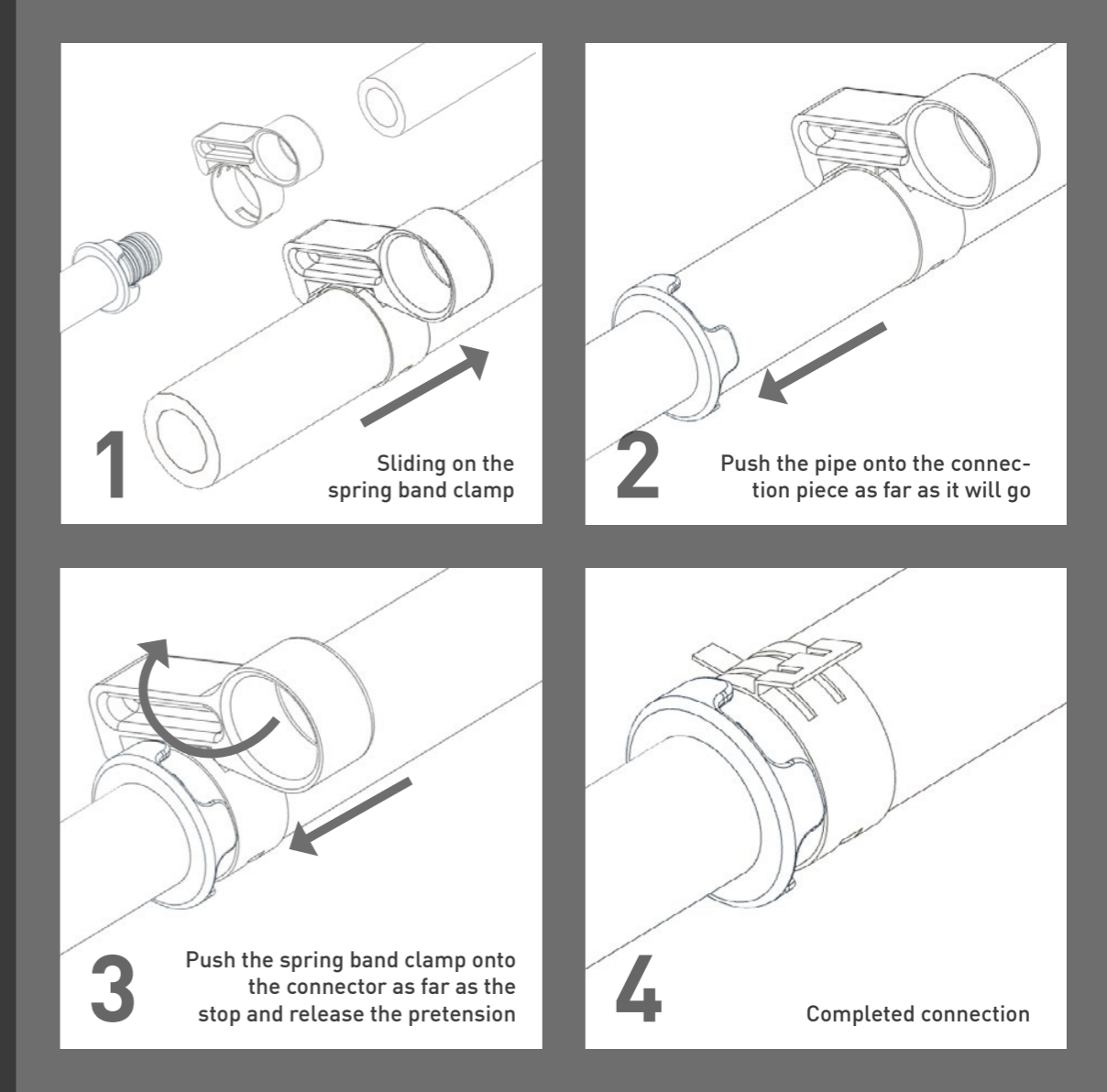

### This is how easy it is to install the new system:

1. Cut the pipe to the desired length
2. Slide on the spring band clamp(s) and push the pipe onto the connection piece as far as it will go
3. Push the spring band clamp as far as it will go on the connector and release the preload

In addition to the specific installation guidelines mentioned above, all installation methods must comply with the recognised rules of technology.





## Welded joint

The aquatherm black heating and cooling grids are joined together using the "heating element socket welding process". The plastic of the connecting parts fuses together to form a strong and tight-fitting unit. Whether you are planning individual connections or large systems with distribution technology - thanks to our extensive range of aquatherm moulded parts, you will find everything you need to complete your project.

### Instructions for optimum processing:

As the wall thicknesses of aquatherm moulded parts and aquatherm black components can vary, slightly different heating times are required. First place the aquatherm moulded parts, which have a thicker wall thickness, on the welding tool and then heat the aquatherm black PP grid pipe.

- Permissible continuous operating pressure 4 bar (at max. 60°C)
- Permissible maximum continuous temperature 60°C
- Max. permissible test pressure 6 bar (analogue AQT leak test)

## Installation of the welded joint

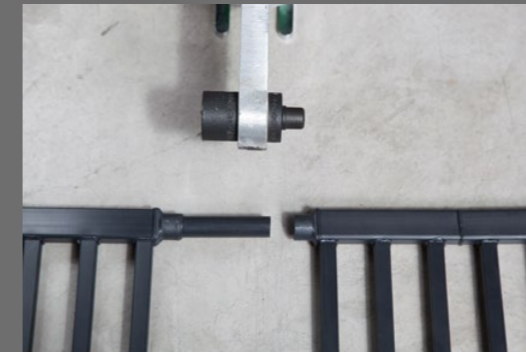

**1** Welding equipment and tools (16mm) fitted, temperature check carried out.



**2** Insert the heating pipe 16 mm into the tool socket and at the same time push the sleeve of the heating grid onto the heating mandrel.



**3** After the prescribed heating time of 5 seconds, remove parts from the tools



**4** ... and push together immediately (welding depth 13 mm).

aquatherm black

with socket weld connection left, right.





## Areas of application

Future-proof in all areas of application with customised solutions. aquatherm black is versatile. Here you will find the most common types of installation:

### NEW BUILDING

#### CEILING



Drywall construction with metal substructure

Drywall construction with wooden substructure

Drywall grid with insert panels

Plastered

Thermally activated ceiling sails

Metal cassette as clamping / suspension system

Metal cassette with tape grid

Metal cassette with expanded metal

Free convection - suspended

Free convection - Direct mounting

#### WALL



Dry construction with metal stud frame

Dry construction with timber stud frame

Plastered



#### FLOOR

Screed



### RENOVATION

#### CEILING



Drywall construction with metal substructure

Drywall construction with wooden substructure

Drywall grid with insert panels

Plastered

Thermally activated ceiling sails

Metal cassette as clamping / suspension system

Metal cassette with tape grid

Metal cassette with expanded metal

Free convection - Suspended

Free convection - Direct mounting

#### WALL



Dry construction with metal stud frame

Dry construction with timber stud frame

Plastered







# Overview

Ceiling 43 44  
P. 42  
Drywall construction with metal substructure

Ceiling 45 46  
P. 52  
Drywall construction with wooden substructure

Ceiling 43 44  
P. 70  
Drywall grid with gypsum plasterboard or mineral fibre inserts

Ceiling 45  
P. 94  
Plastered

Ceiling 43  
P. 100  
Thermally activated ceiling sails

Ceiling 43 44  
P. 106  
Metal cassette as a clamping/hanging system

Ceiling 43 44  
P. 116  
Metal cassette with tape grid

Ceiling 43 44  
P. 130  
Metal cassette with expanded metal

Ceiling 43 45  
P. 140  
Free convection - suspended

Ceiling 45  
P. 150  
Free convection - direct mounting

Wall 46  
P. 156  
Metal stud frame and panelling with building boards

Wall 46  
P. 166  
Timber stud frame and panelling with building boards

Wall 45  
P. 176  
Plastered

Floor 45  
P. 184  
Screed

43 Steckanschluss 45° Einseitig  
44 Steckanschluss 45° Wechelseitig  
45 Schweißanschluss Einseitig  
46 Steckanschluss Einseitig





## Ceiling system: Drywall construction with metal substructure

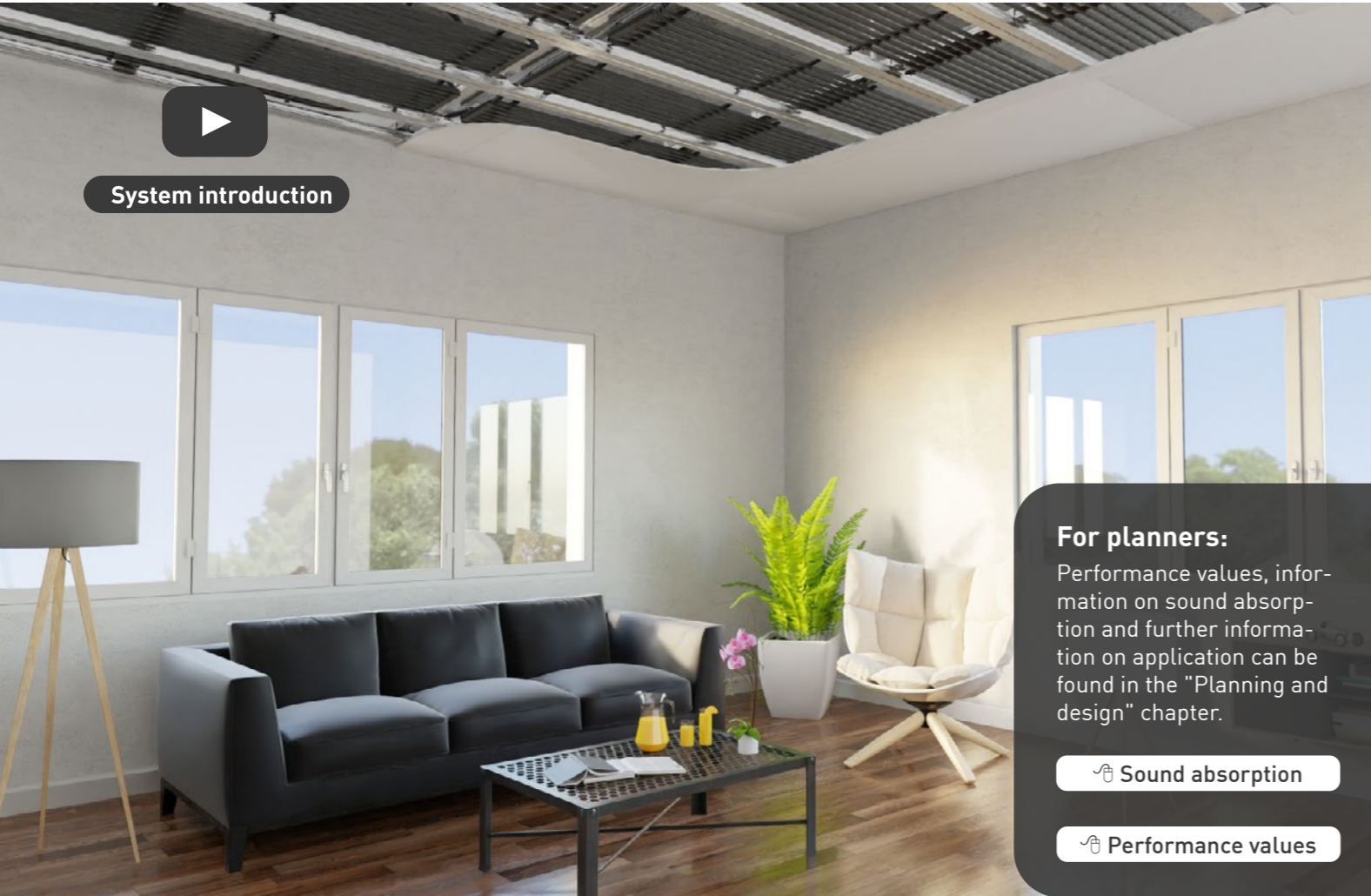

### Advantages

- High heating and cooling performance thanks to the very good contact with the building panel and the large thermal transfer surface of the square tube grid.
- A high level of sound absorption is achieved in combination with perforated plasterboard panels.
- Efficient use of heat pumps and renewable energies.
- High sound absorption in combination with perforated plasterboard panels.
- Combination of thermally active and passive ceiling elements.
- Clear separation of the two trades building services and drywall construction.
- Installation of the grids in standard dry construction without interfering with the substructure.
- Installation in combination with various ceiling installations and ceiling superstructures such as e.g. lights, fire detectors and ventilation components.
- Attractive design and architectural freedom in the design of the ceiling surfaces.
- Rapid construction progress thanks to dry construction systems.

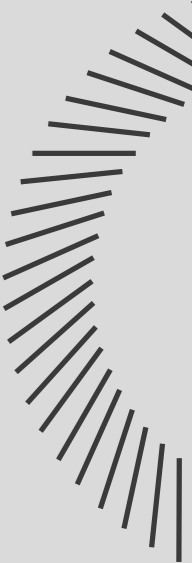
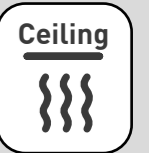

### System description

Installation of the aquatherm black energy grid is simple: It is installed between the support profiles of the metal substructure. The ceiling is then planked with building boards. For example, plasterboard panels with different thermal conductivities can be used. The energy grids are available in different widths and lengths so that the ceiling can be customised.





## Ceiling system: Drywall construction with metal substructure

### ASSEMBLY DESCRIPTION

#### Grid with push-fit connection 45° left, right (one-sided)

CONNECTION TYPE 43

#### 1. Substructure (on site)

The substructure must be installed in accordance with the recognised rules of technology, generally applicable standards and regulations and the manufacturer's instructions. The substructure must be installed in accordance with the provisions of DIN 18182 and DIN EN 14195. Care must be taken to ensure horizontal and aligned installation.

To ensure that the grids can be installed smoothly, the clear suspended height must be at least 120 mm. The centre-to-centre distance of the supporting structure depends on the construction panel used and varies between 333 and 400 mm.

#### 2. Installation of the aquatherm black energy grid

All grids are adapted to the standard dimensions of the substructure. The grids are installed between the support profiles in accordance with the installation plan. The specifications of the manufacturer of the building boards used must be observed.

The grids are secured with the fixing rails for drywall and connecting plugs.

If the ceiling is not closed directly by the drywall contractor, we recommend securing the grids with an additional fastening (e.g. plastic tape).

#### 3. Connection of the aquatherm black energy grid

The grids are equipped with a 45° push-fit connection on the left, right (one-sided). After installing the grids in the supporting structure, they are connected to each other to form heating or cooling circuits in accordance with the installation plan.

The Flexible connection pipe 20 x 3.4 mm with our spring band clamps is used for this (see connection detail).

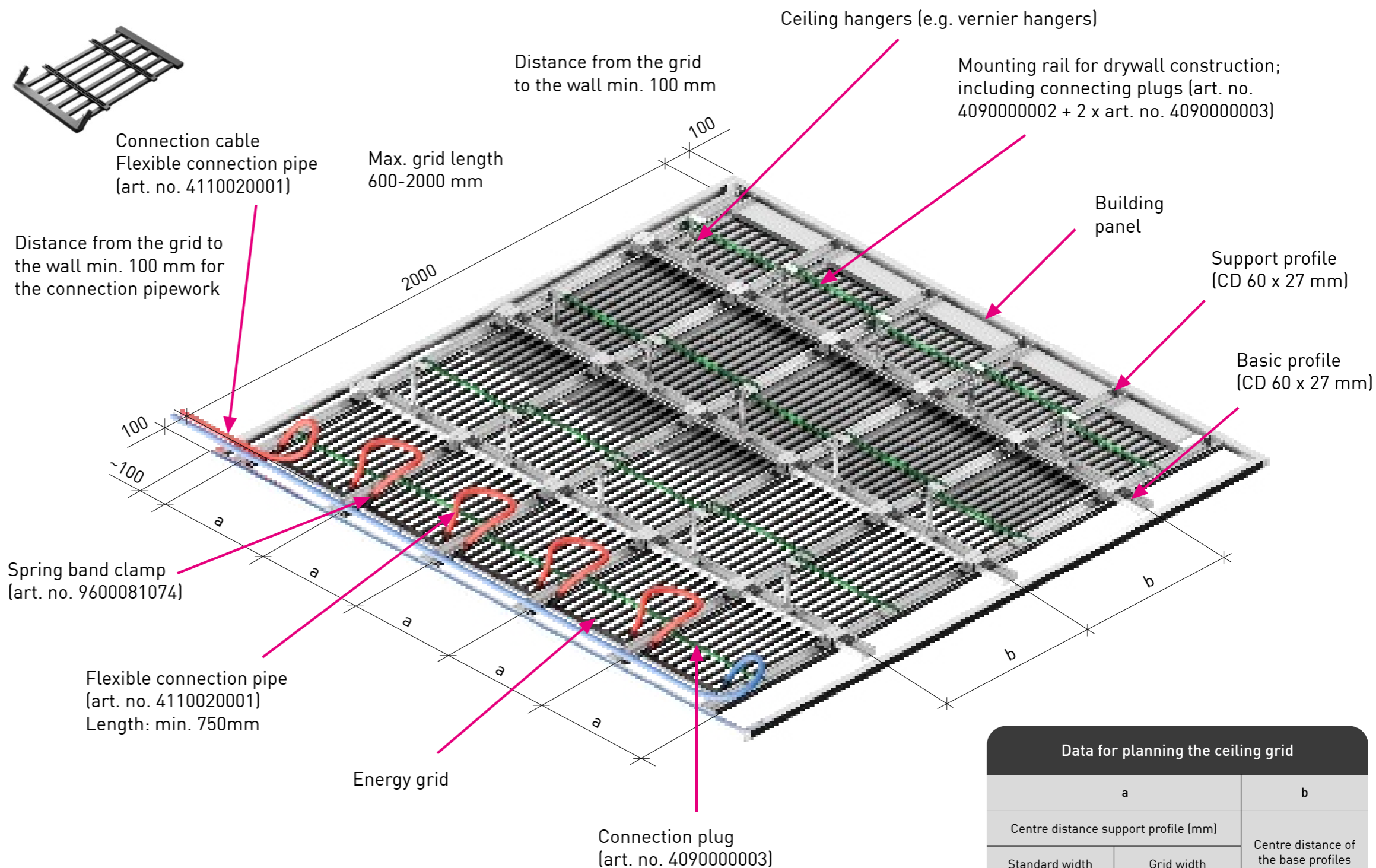

Special dimensions on request

Data for planning the ceiling grid

a		b
Centre distance support profile (mm)		Centre distance of the base profiles and the fastening according to the manufacturer's specifications
Standard width	Grid width	
333	240	
400	320	

The 333 mm grid is used with perforated plasterboard for sound-absorbing heating and cooling systems!





## Ceiling system: Drywall construction with metal substructure

### ASSEMBLY DESCRIPTION

#### Grid with push-fit connection 45° left, right (one-sided)

CONNECTION TYPE 43

#### 4. Connection pipework of the aquatherm black energy grid to the distribution system

The connection of the heating/cooling circuits from the manifold or the main pipework is routed into the room, e.g. through the wall/ceiling, in accordance with the applicable regulations. The Flexible connection pipe 20 x 3.4 mm can be used for this. We recommend fastening the connecting pipes with plastic fastening clamps in accordance with our specifications.

#### 5. Assembly of the building boards (on site)

The grid hangs a few millimetres below the support profiles. The building boards are now screwed to the substructure in a single layer in accordance with the manufacturer's instructions. This presses the grids upwards. This creates direct contact between the building board and the grid. It must be ensured that the grids are filled with water (or the corresponding medium) during installation of the building boards and are under system pressure. Installation must be carried out in accordance with the provisions of DIN 18180. Any insulation required in accordance with fire protection or sound insulation requirements should also be installed.

#### Notes:

The use of wallpaper, backing tiles and acoustic plasters leads to a reduction in heating and cooling performance.

The material for the substructure and the building boards must be provided by the customer.

#### Detail: Push-fit connection 45° left, right (one-sided)

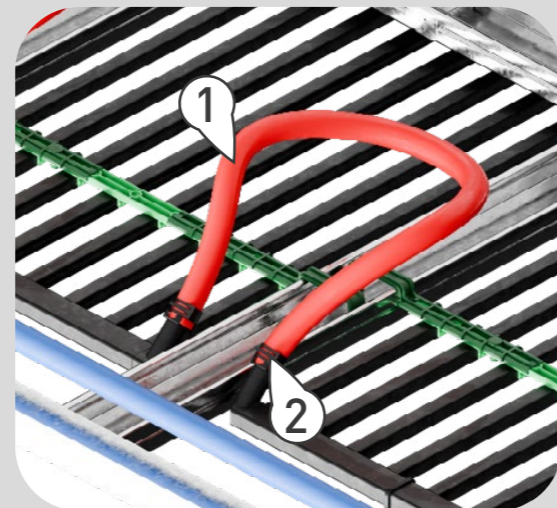

1. Flexible connection pipe  
(art. no. 4110020001)  
Minimum length: 0.75m

2. Spring band clamp  
(art. no. 9600081074)

#### Detail: Mounting rail

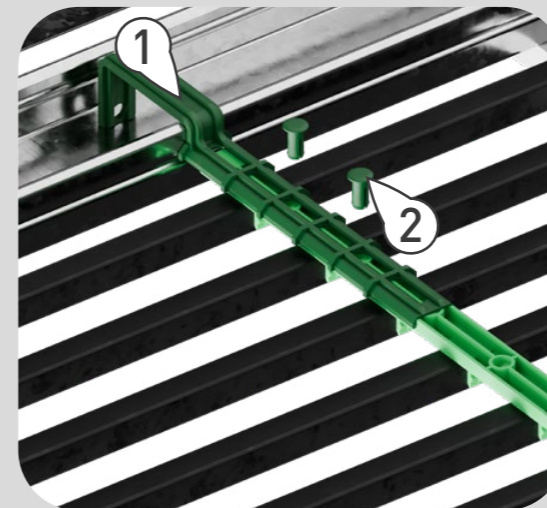

1. Mounting rail for  
drywall construction  
(art. no. 4090000002)

2. Two connecting plugs  
per mounting rail  
(art. no. 4090000003)

#### Detail: Support profile

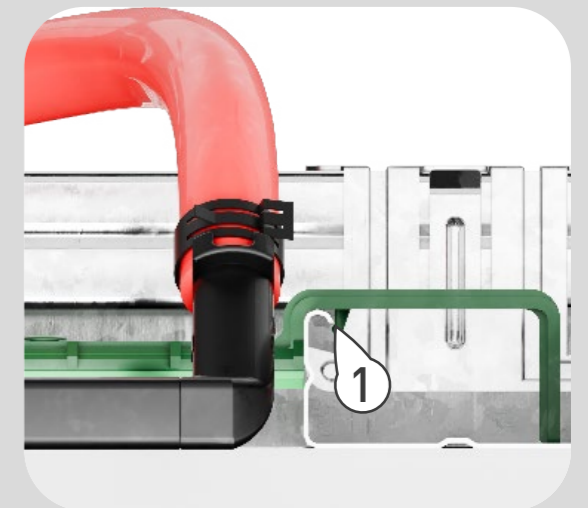

1. Snap-in mounting rail  
in the support profile  
(art. no. 4090000002)

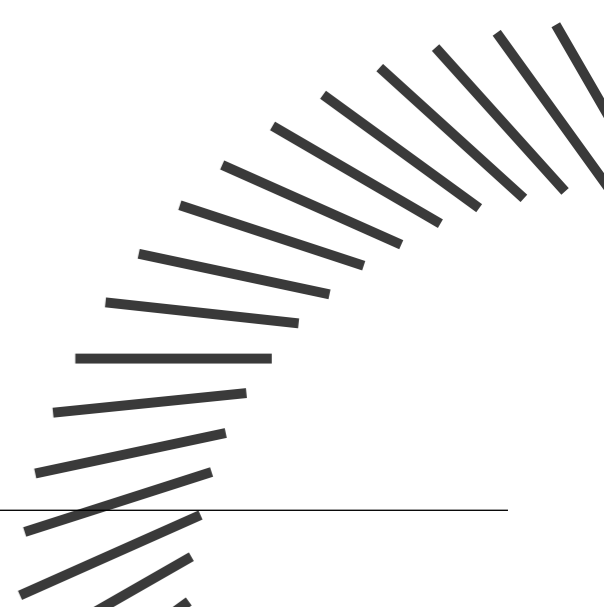





# Ceiling system: Drywall construction with metal substructure

### ASSEMBLY DESCRIPTION

**Grid with push-fit connection  
45° top left, bottom right (mutual)**

CONNECTION TYPE 44

#### 1. Substructure (on site)

The substructure must be installed in accordance with the recognised rules of technology, generally applicable standards and regulations and the manufacturer's instructions. The substructure must be installed in accordance with the provisions of DIN 18182 and DIN EN 14195. Care must be taken to ensure horizontal and aligned installation.

To ensure that the grids can be installed smoothly, the clear suspended height must be at least 120 mm. The centre-to-centre distance of the supporting structure depends on the construction panel used and varies between 333 and 400 mm.

#### 2. Installation of the aquatherm black energy grid

All grids are adapted to the standard dimensions of the substructure. The grids are installed between the support profiles in accordance with the installation plan. The specifications of the manufacturer of the building boards used must be observed.

The grids are secured with the fixing rails for drywall and connecting plugs.

If the ceiling is not closed directly by the drywall contractor, we recommend securing the grids with an additional fastening (e.g. plastic tape).

#### 3. Connection of the aquatherm black energy grid

The grids are equipped with a **45° push-fit connection top left, bottom right (mutual)**. Once the grids have been installed in the supporting structure, they are connected to each other to form heating or cooling circuits in accordance with the installation plan.

The flexible connection pipe 20 x 3.4 mm with our spring band clamps is used for this (see connection detail).

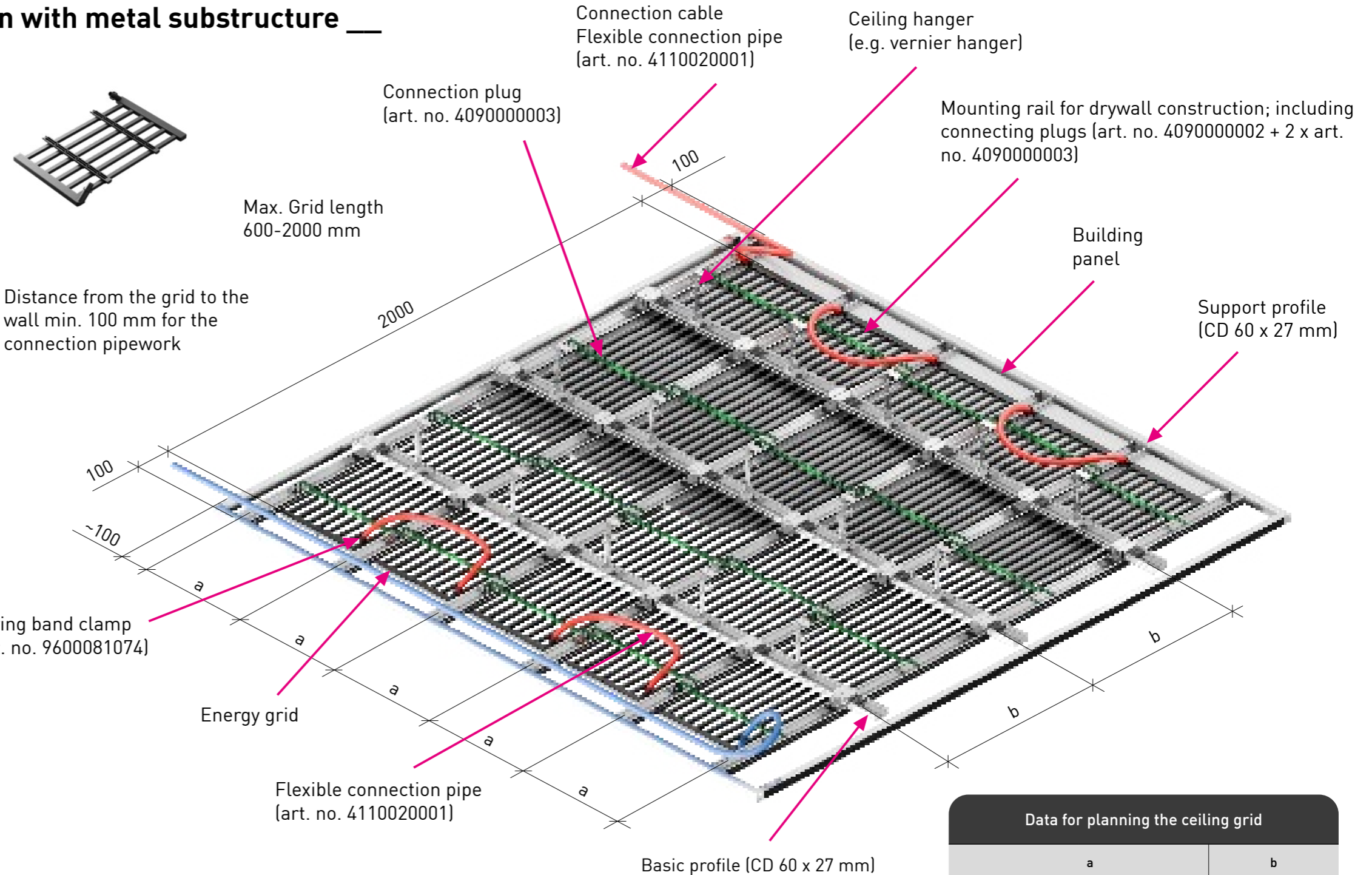

**Special dimensions on request**

Data for planning the ceiling grid		
a		b
Centre distance support profile (mm)		Centre distance of the base profiles and the fastening according to the manufacturer's specifications
Standard width	Grid width	
333	240	
400	320	

The 333 mm grid is used with perforated plasterboard for sound-absorbing heating and cooling systems!





## Ceiling system: Drywall construction with metal substructure

### ASSEMBLY DESCRIPTION

#### Grid with push-fit connection 45° top left, bottom right (mutual)

CONNECTION TYPE 44

#### 4. Connection pipework of the aquatherm black energy grid to the distribution system

The connection of the heating/cooling circuits from the manifold or the main pipework is routed into the room, e.g. through the wall/ceiling, in accordance with the applicable regulations. The Flexible connection pipe 20 x 3.4 mm can be used for this. We recommend fastening the connecting pipes with plastic fastening clamps in accordance with our specifications.

#### 5. Assembly of the building boards (on site)

The grid hangs a few millimetres below the support profiles. The building boards are now screwed to the substructure in a single layer in accordance with the manufacturer's instructions. This presses the grids upwards. This creates direct contact between the building board and the grid. It must be ensured that the grids are filled with water (or the corresponding medium) during installation of the building boards and are under system pressure. Installation must be carried out in accordance with the provisions of DIN 18180. Any insulation required in accordance with fire protection or sound insulation requirements should also be installed.

#### Notes:

The use of wallpaper, backing tiles and acoustic plasters leads to a reduction in heating and cooling performance. The material for the substructure and the building boards must be provided by the customer.

#### Detail: 45° push-fit connection top left, bottom right

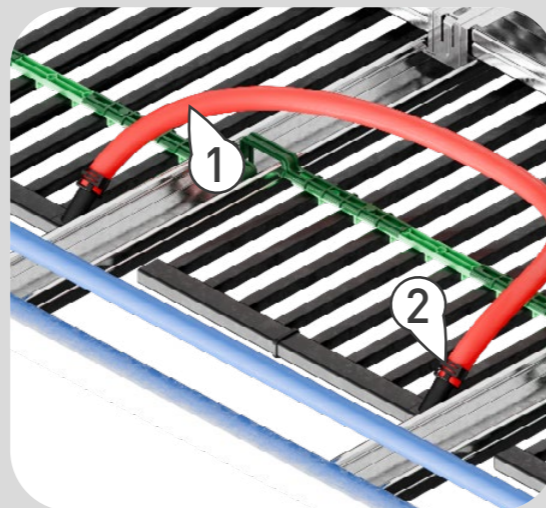

1. Flexible connection pipe  
(art. no. 4110020001)  
Minimum length: 0.75m

2. Spring band clamp  
(art. no. 9600081074)

#### Detail: Mounting rail

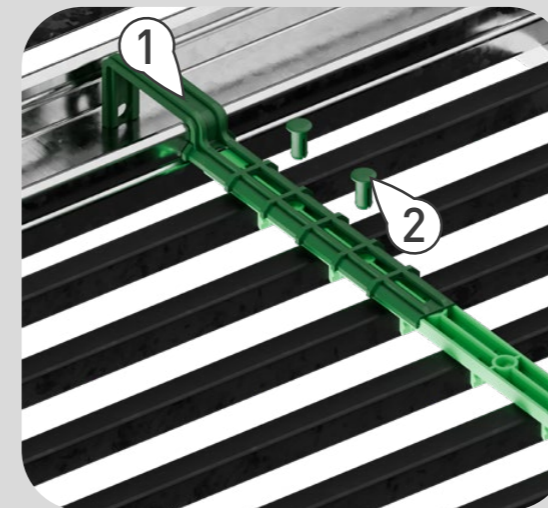

1. Mounting rail for  
drywall construction  
(art. no. 4090000002)

2. Two connecting plugs  
per mounting rail  
(art. no. 4090000003)

#### Detail: Support profile

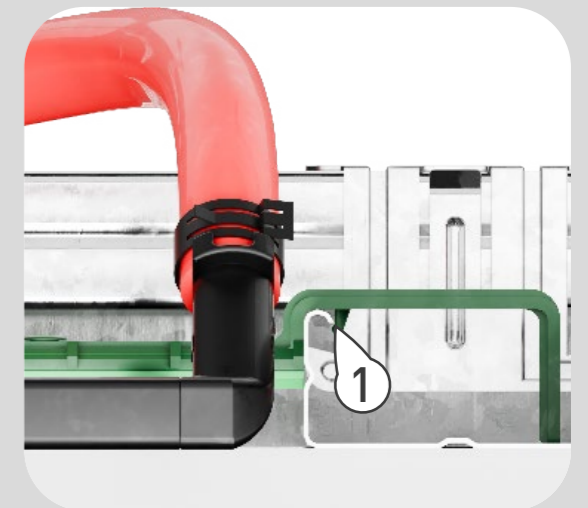

1. Snap-in mounting rail  
in the support profile  
(art. no. 4090000002)

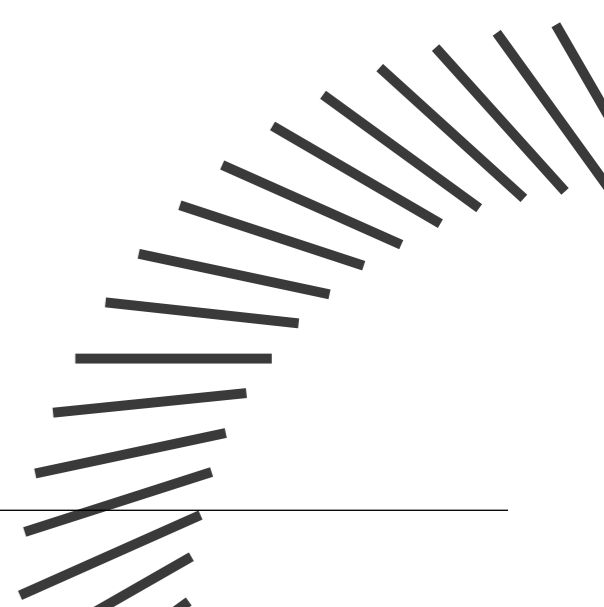





## Ceiling system: Drywall construction with wooden substructure

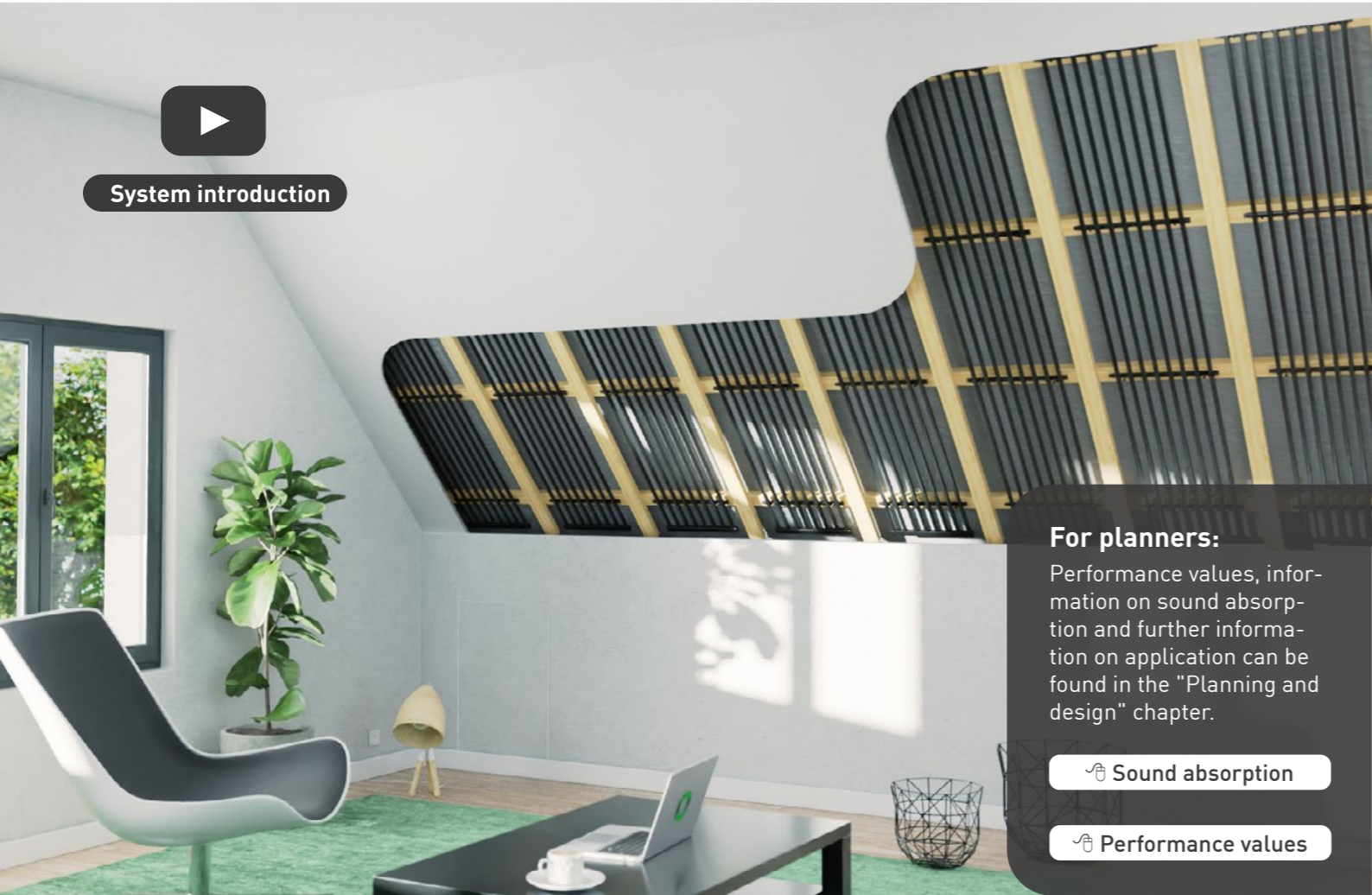

### For planners:

Performance values, information on sound absorption and further information on application can be found in the "Planning and design" chapter.

🔊 Sound absorption

📊 Performance values

### Advantages

- High heating and cooling performance thanks to the very good contact with the building panel and the large thermal transfer surface of the square tube grid.
- Combination with centrally treated outside air possible.
- Efficient use of heat pumps and renewable energies.
- A high level of sound absorption is achieved in combination with perforated plasterboard panels.
- Combination of thermally active and passive ceiling elements.
- Clear separation of the two trades building services and drywall construction.
- Installation of the grids in standard dry construction without interfering with the substructure.
- Installation in combination with various ceiling installations and ceiling superstructures such as e.g. lights, fire detectors and ventilation components.
- Attractive design and architectural freedom in the design of the ceiling surfaces.
- Rapid construction progress thanks to dry construction systems.

Ceiling



### System description

With this system, the aquatherm black grid is installed between the supporting battens and the wooden substructure. The wall or ceiling is then planked with building boards, for example made of plasterboard. Thanks to different grid widths and lengths, the surface can be fitted in different ways, creating free space for ceiling installations (spotlights, suspensions for lighting, smoke detectors, etc.), for example.







## Ceiling system: Drywall construction with wooden substructure Push-fit clamps

### ASSEMBLY DESCRIPTION

**Grid with push-fit connection left, right (one-sided)**

CONNECTION TYPE 46



#### 1. Substructure (on site)

The substructure must be installed in accordance with the recognised rules of technology, generally applicable standards and regulations and the manufacturer's instructions. The substructure must be installed in accordance with the provisions of DIN 18182 and DIN EN 14195. Care must be taken to ensure horizontal and aligned installation.

In order to ensure a smooth installation process for the grids, the wood profile thickness must be at least 48 x 24 mm. The centre-to-centre distance of the wooden profiles is 400 mm.

#### 2. Installation of the aquatherm black energy grid

All grids are adapted to the standard dimensions of the timber substructure. The grids are installed between the support profiles in accordance with the installation plan. The specifications of the manufacturer of the building boards used must be observed.

The grids are secured with fixing rails for drywall and connecting plugs.

If the ceiling is not closed directly by the drywall contractor, we recommend securing the grids with an additional fastening (e.g. plastic tape).

#### 3. Connection of the aquatherm black energy grid

The grids are equipped with a push-fit connection on the left, right (one-sided). After installing the grids in the wooden substructure, they are connected to each other to form heating or cooling zones in accordance with the installation plan. The Flexible connection pipe 20 x 3.4 mm with our spring band clamps is used for this (see connection detail).

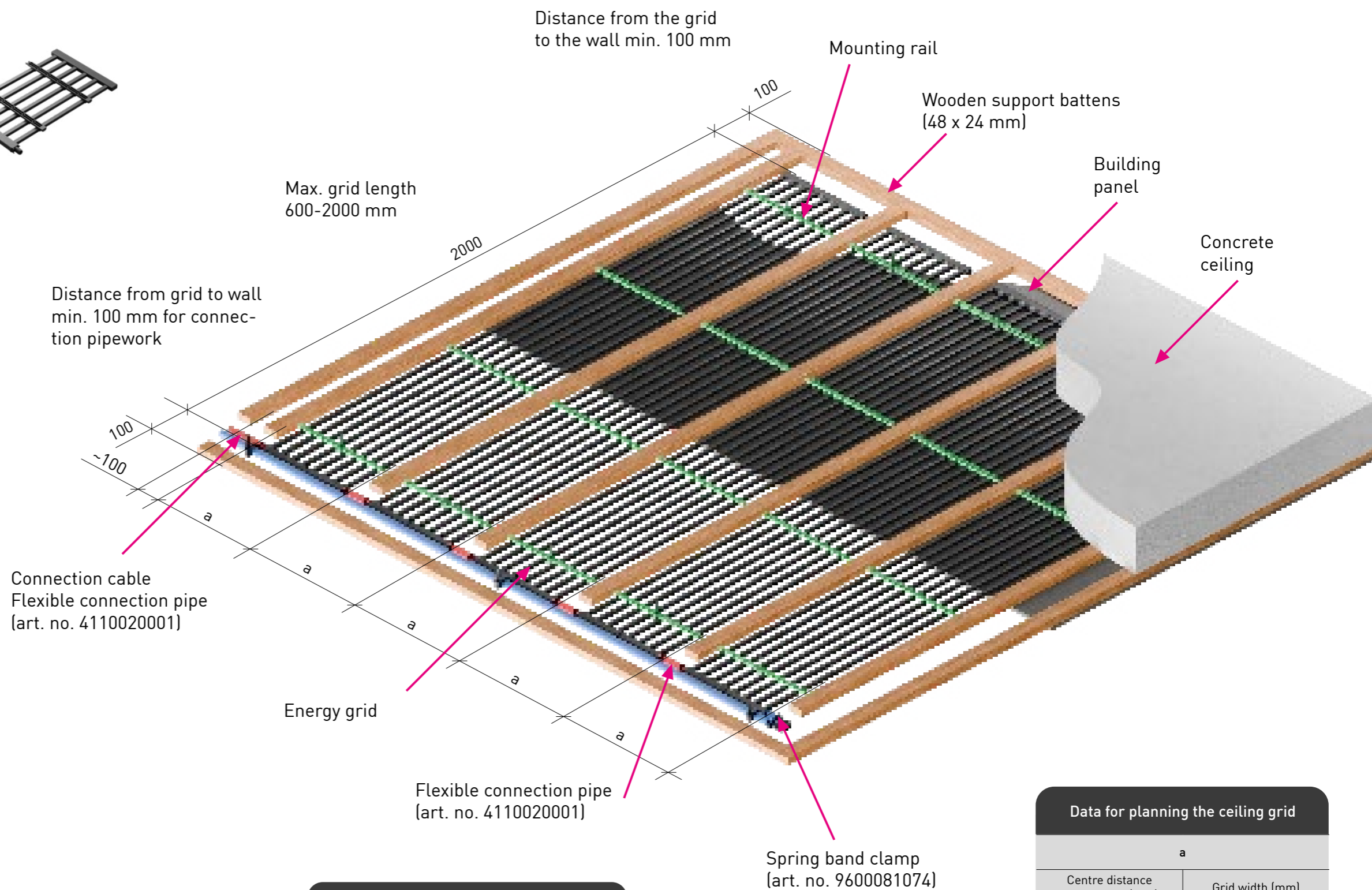

**Special dimensions on request**

Data for planning the ceiling grid	
a	
Centre distance Support bar (mm)	Grid width (mm)
400	320





## Ceiling system: Drywall construction with wooden substructure      Plug-in clamps

### ASSEMBLY DESCRIPTION

#### Grid with push-fit connection left, right (one-sided)

CONNECTION TYPE 46

#### 4. Connection pipework of the aquatherm black energy grid to the distribution system

The connection of the heating / cooling circuits from the manifold or the main pipework is routed into the room through the floor / wall / ceiling, for example, in accordance with the applicable regulations. The Flexible connection pipe 20 x 3.4 mm can be used for this.

We recommend fastening the connecting cables with black plastic fastening clips in accordance with our specifications.

#### 5. Mounting the building boards

The building boards are now screwed to the wooden profiles according to the manufacturer's instructions. It must be ensured that the grids are filled with water (or the corresponding medium) and are under system pressure during the installation of the building boards. Installation must be carried out in accordance with the provisions of DIN 18180. Any insulation required in accordance with fire protection or sound insulation requirements should also be installed.

#### Notes:

The use of wallpaper, backing tiles and acoustic plasters leads to a reduction in heating and cooling performance. The material for the substructure and the building boards must be provided by the customer.

### Section: Fixing the ceiling grid

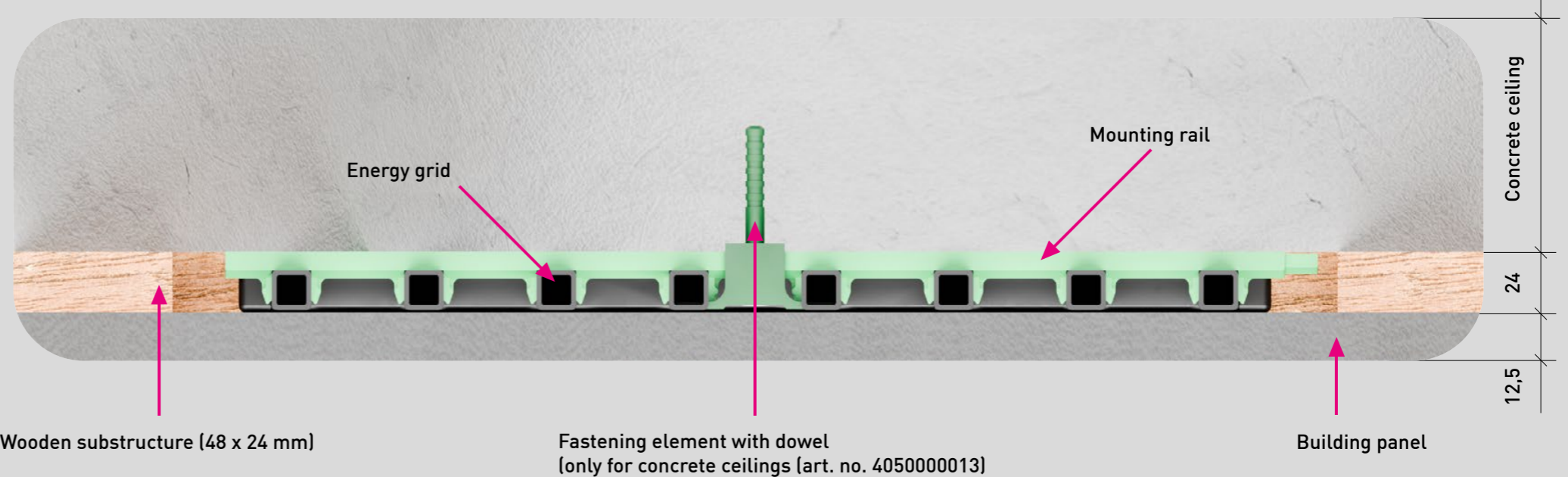





## Ceiling system: Drywall construction with wooden substructure \_\_\_ Plug-in clamps

Detail: Connection

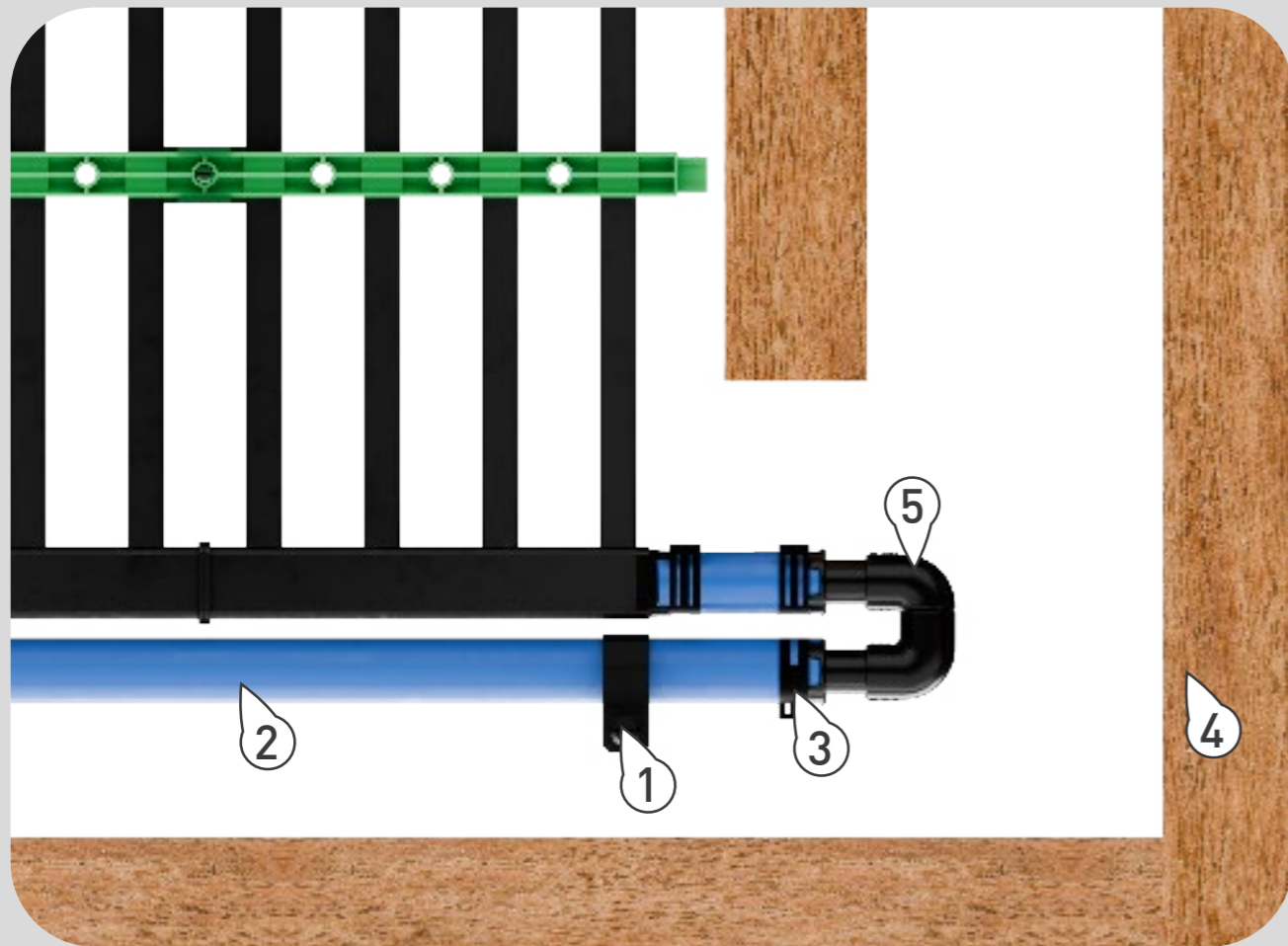

- 1. Plastic fastening clamp (art. no. 4090020008)
- 2. Flexible connection pipe (art. no. 4110020001)
- 3. Spring band clamp (art. no. 9600081074 )
- 4. Wooden support battens (48 x 24 mm)
- 5. Angle 180° (art. no. 4090016008)

Detail: Fixing the ceiling grid

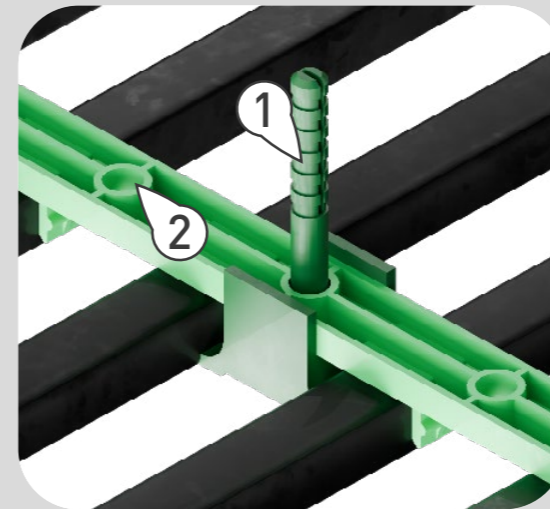

- 1. Fastening element with dowel (art. no. 4050000013)  
Recommendation: 8 pieces per m<sup>2</sup> active area
- 2. Mounting rail

Detail: Fastening of the connection pipework

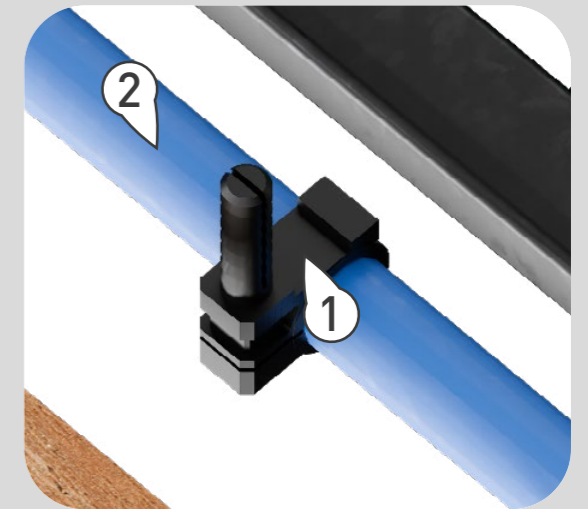

- 1. Plastic fastening clip (art. no. 4090020008)
- 2. Connection pipework (art. no. 4110020001)





## Ceiling system: Drywall construction with wooden substructure

### Plasterboard ceiling system - single-layer planking

Centre distance support profile unperforated plasterboard = 400 mm

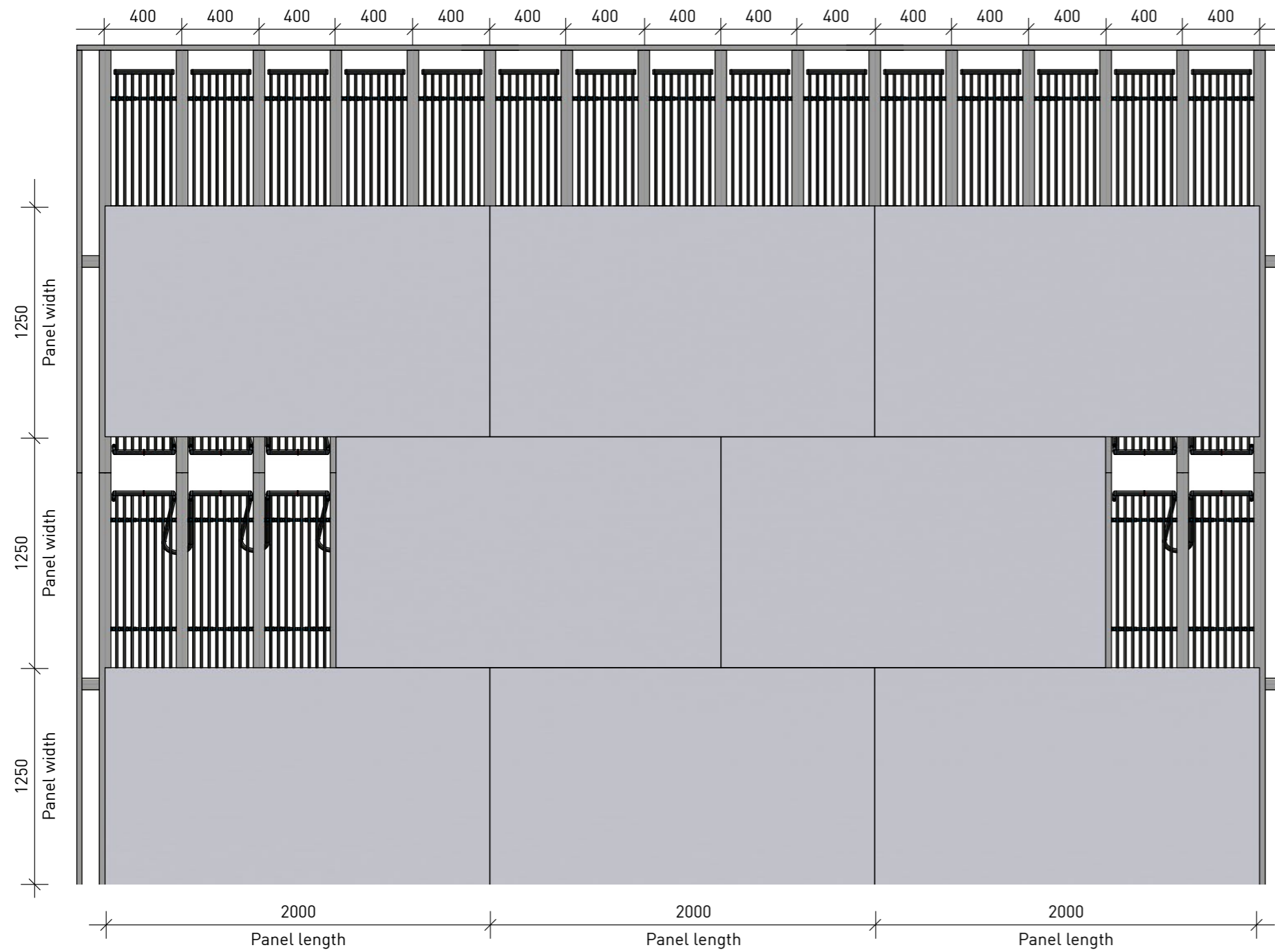





# Ceiling system: Drywall construction with wooden substructure Welding

## ASSEMBLY DESCRIPTION

**Grid with welded connection**  
**Socket left, right (one-sided)**

CONNECTION TYPE 45



### 1. Substructure (on site)

The substructure must be installed in accordance with the recognised rules of technology, generally applicable standards and regulations and the manufacturer's instructions. The substructure must be installed in accordance with the provisions of DIN 18182 and DIN EN 14195. Care must be taken to ensure horizontal and aligned installation.

In order to ensure a smooth installation process for the grids, the wood profile thickness must be at least 48 x 24 mm. The centre-to-centre distance of the wooden profiles is 400 mm.

### 2. Installation of the aquatherm black Heating and cooling grid

All grids are adapted to the standard dimensions of the timber substructure. The grids are installed between the support profiles in accordance with the installation plan. The specifications of the manufacturer of the building boards used must be observed. The grids are secured with fixing rails for drywall and connecting plugs. If the ceiling is not closed directly by the drywall contractor, we recommend securing the grids with an additional fastening (e.g. plastic tape).

### 3. Connection of the aquatherm black Heating and cooling grid

The grids are equipped with a welded connection on the left, right (one-sided). Once the grids have been installed in the wooden substructure, they are connected to each other to form heating or cooling circuits in accordance with the installation plan. The PP 16x2 mm grid pipe is used for the welded connection. (See detailed connection).

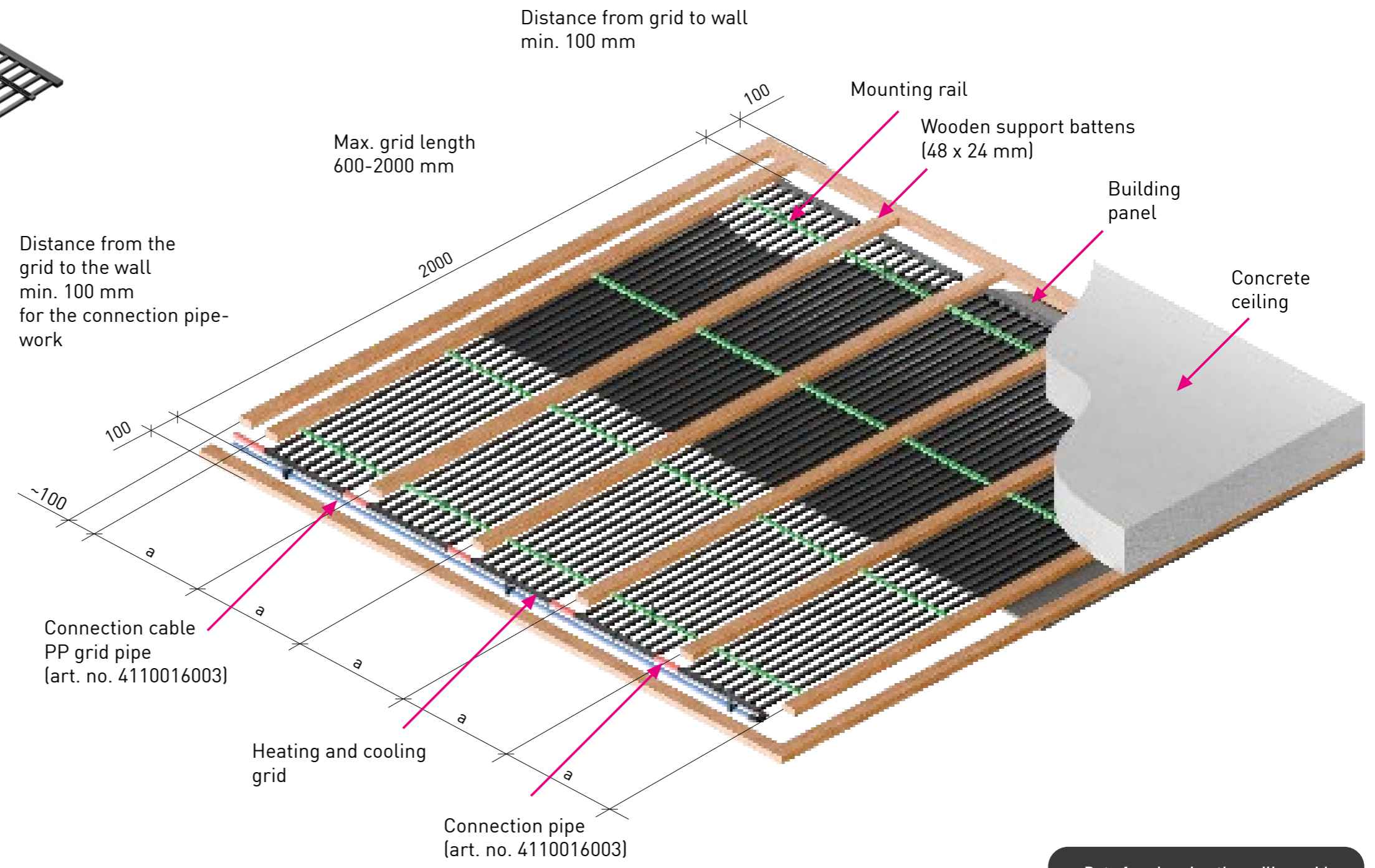

**Special dimensions on request**

Data for planning the ceiling grid	
a	
Centre distance Support bar (mm)	Grid width (mm)
400	320





## Ceiling system: Drywall construction with wooden substructure Welding

### ASSEMBLY DESCRIPTION

Grid with welded connection  
Socket left, right (one-sided)

CONNECTION TYPE 45

#### 4. Connection pipework of the aquatherm black heating and cooling grid to the distribution system

The connection of the heating / cooling circuits from the manifold or the main pipework is routed into the room, e.g. through the wall / ceiling, in accordance with the applicable regulations. The aquatherm black PP grid pipe 16 x 2 mm can be used for this purpose. We recommend fastening the connecting pipes with plastic fastening clamps in accordance with our specifications (aquatherm black installation principles).

#### 5. Assembly of the building boards (on site)

The building boards are now screwed to the wooden profiles according to the manufacturer's instructions. Ensure that the grids are filled with water (or the corresponding medium) and are under system pressure during installation of the building boards. Installation must be carried out in accordance with the provisions of DIN 18180. Any insulation required in accordance with fire protection or sound insulation requirements should also be installed.

#### Notes:

The use of wallpaper, backing tiles and acoustic plasters leads to a reduction in heating and cooling performance. The material for the substructure and the building boards must be provided by the customer.

### Section: Fixing the ceiling grid

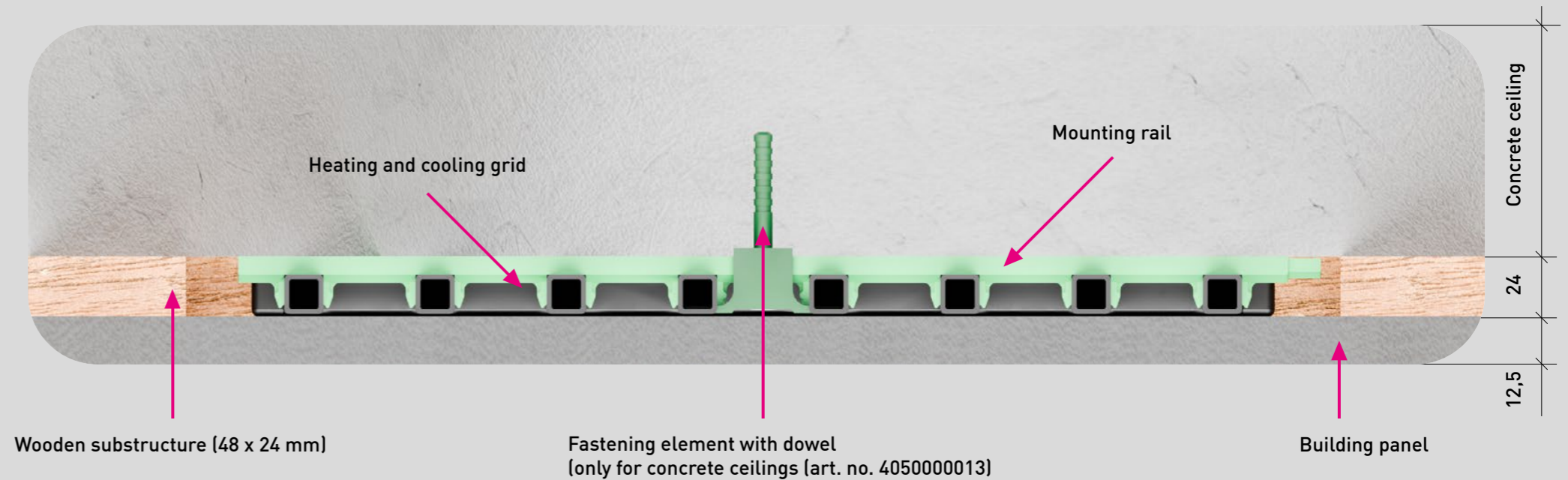





## Ceiling system: Drywall construction with wooden substructure — Welding

Detail: Connection

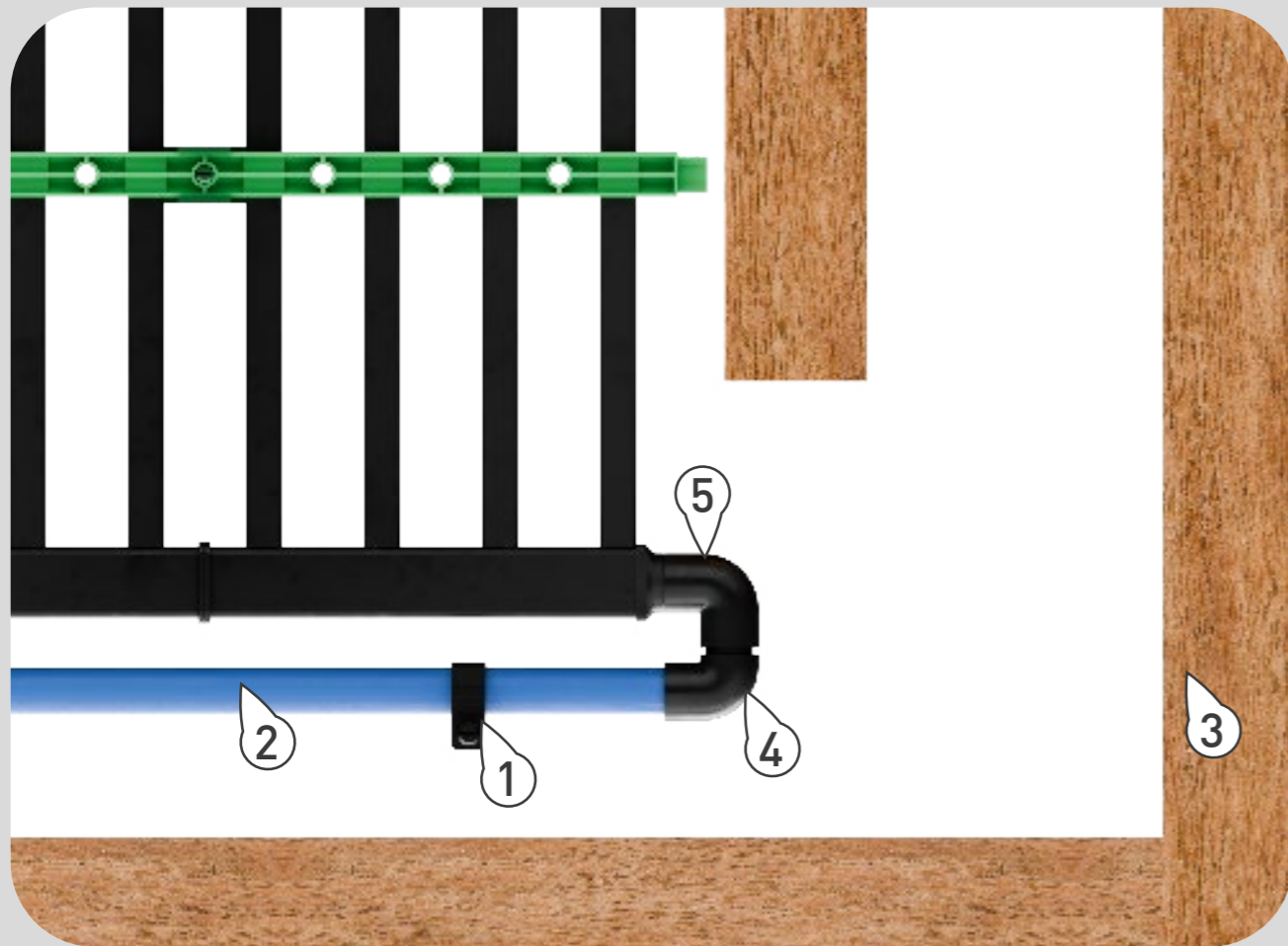

1. Plastic fastening clamp (art. no. 4090016006)
2. PP grid tube (art. no. 4110016003)
3. Wooden support battens (48 x 24 mm)
4. Angle 90° inside / inside (art. no. 4080016000)
5. Angle 90° inside / outside (art. no. 4080016001)

Detail: Fixing the ceiling grid

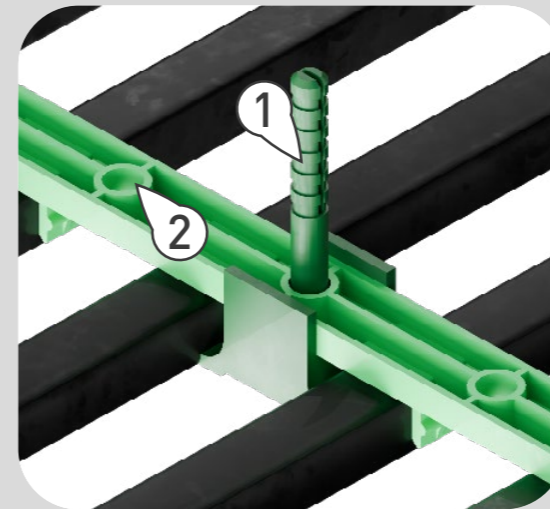

1. Fastening element with dowel (art. no. 4050000013)  
Recommendation: 8 pieces per m<sup>2</sup> active area
2. Mounting rail

Detail: Fastening of the connection pipework

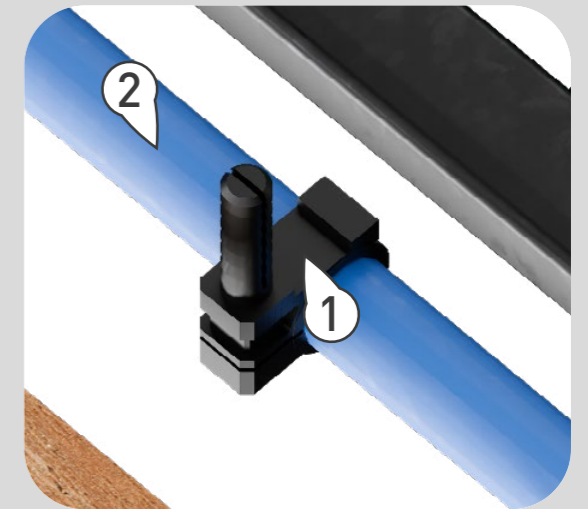

1. Plastic fastening clip (art. no. 4090016006)
2. Connection pipework (art. no. 4110016003)





## Ceiling system: Drywall construction with wooden substructure

### Plasterboard ceiling system - single-layer planking

Centre distance support profile unperforated plasterboard = 400 mm

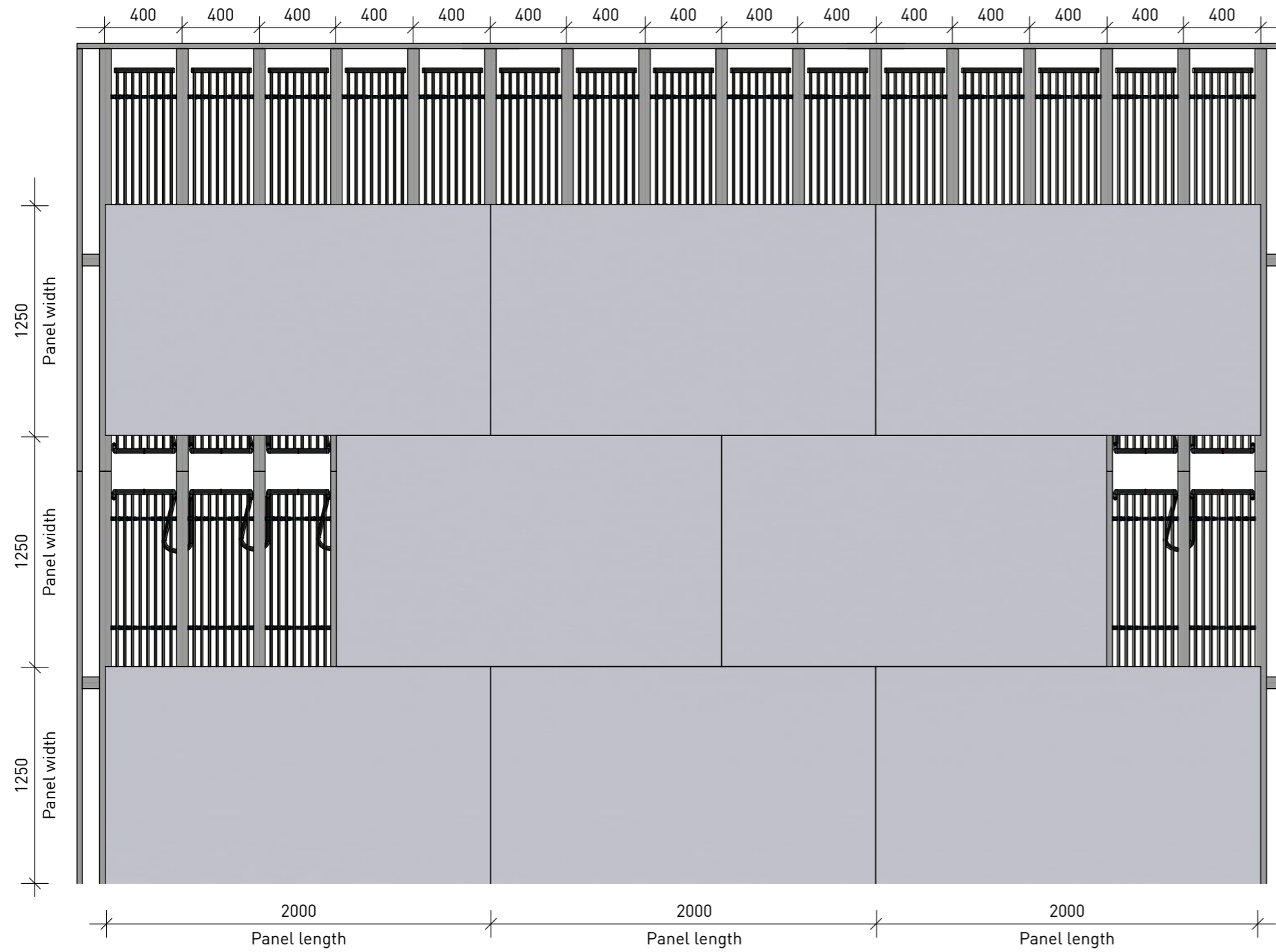





## Ceiling system: Drywall grid with insert panels made of plasterboard or mineral fibre\_\_

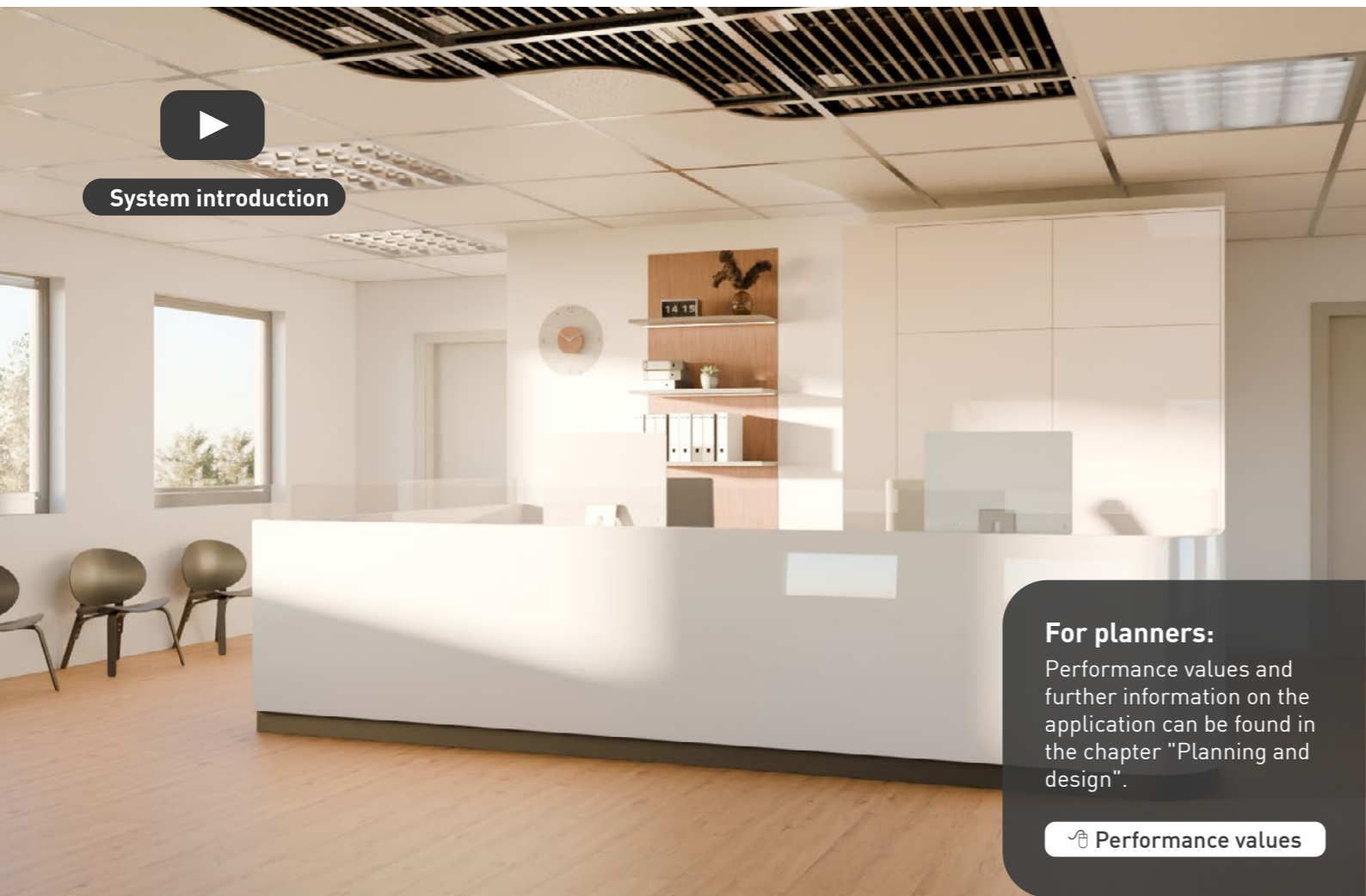

### For planners:

Performance values and further information on the application can be found in the chapter "Planning and design".

[Performance values](#)

### Advantages

- High heating and cooling performance through direct contact with the insert plates.
- Factory prefabricated grid modules for quick installation on site.
- Efficient use of heat pumps and renewable energies.
- The system can be retrofitted into existing ceiling systems.
- High sound absorption with perforated ceiling panels and acoustic fleece.
- Installation in combination with various ceiling installations/structures such as lights, fire detectors and ventilation components.
- Power output without draughts.
- Silent and invisible heating and cooling function.
- Quick and easy installation thanks to fixing via heat conducting modules.
- Increased performance through heat conducting modules.



### System description

The aquatherm black energy grids for heating and cooling are glued to the plasterboard or mineral fibre insert panels on site. Direct contact between the grids and the insert panels ensures good power transfer.

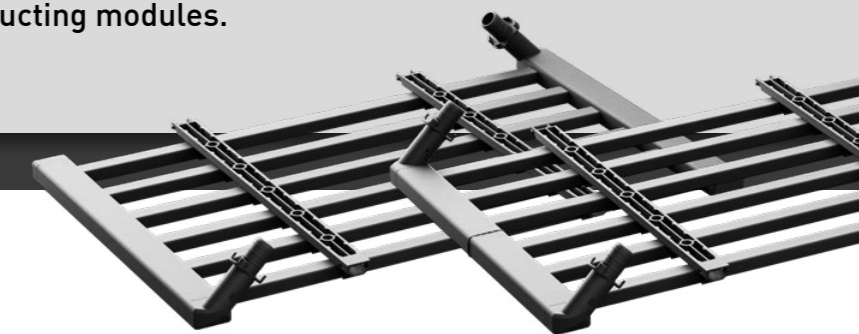



## Ceiling system: Drywall grid with insert panels made of plasterboard or mineral fibre

### ASSEMBLY DESCRIPTION

Grid with push-fit connection  
45° left, right (one-sided)

CONNECTION TYPE 43

#### 1. Substructure (on site)

The substructure must be installed in accordance with the recognised rules of technology, generally applicable standards and regulations and the manufacturer's instructions. The substructure must be installed in accordance with the provisions of DIN 18168 and DIN EN 13964. Care must be taken to ensure horizontal and aligned installation. To ensure smooth installation of the grids, the clear suspended height must be at least 150 mm.

#### 2. Installation of the aquatherm black energy grid

To ensure a smooth installation process, the centre suspension height of the metal ceiling should be at least 150 mm.

#### 3. Connection of the aquatherm black energy grid

The grids for installation in a ceiling system for insert panels are equipped with a 45° push-fit connection (left, right - one-sided). After mounting the grids on the insert plates, they are connected to each other to form heating or cooling zones according to the assembly plan.

#### Notes:

The grids are placed on the insert panels according to the installation plan and fixed in place using heat conducting modules (100 mm aluminium sheet strips). Depending on requirements, mineral wool insulation (min. 30 mm, shrink-wrapped in PE film) can be placed on the grids.

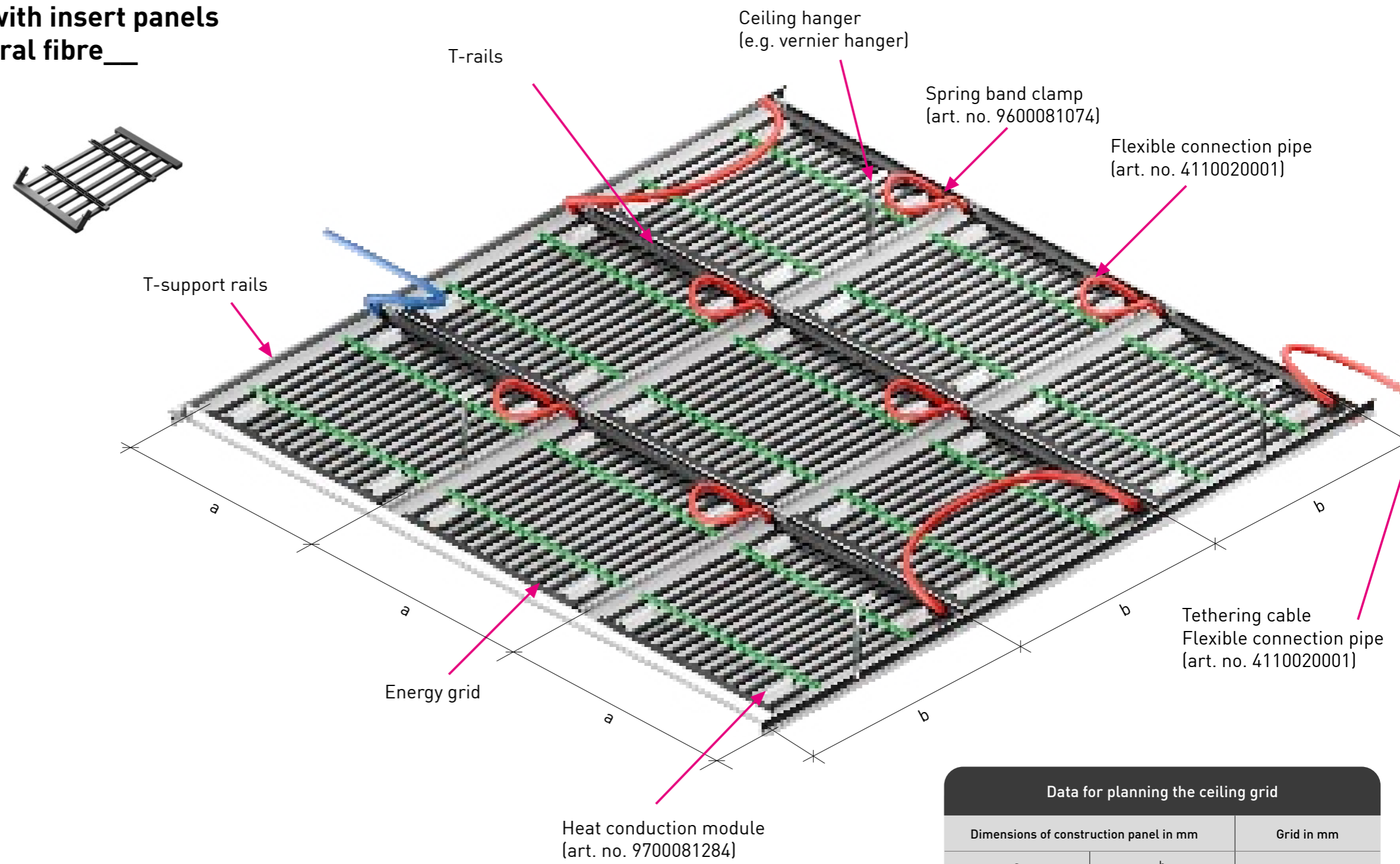

Mounting with heat conducting modules	
Grid	Heat conducting modules
1m <sup>2</sup>	12

Data for planning the ceiling grid		
Dimensions of construction panel in mm		Grid in mm
a	b	-
600	600	560 x 580
625	625	560 x 600
600	1200	560 x 1180
625	1250	560 x 1200
Spacing of the substructure according to manufacturer's instructions		
Special solutions on request		





## Ceiling system: Drywall grid with insert panels made of plasterboard or mineral fibre

### ASSEMBLY DESCRIPTION

#### Grid with push-fit connection 45° left, right (one-sided)

CONNECTION TYPE 43

#### 4. Connection pipework of the aquatherm black energy grid to the distribution system

The connection of the heating/cooling circuits from the manifold or the main pipework is routed into the room, e.g. through the floor/wall/ceiling, in accordance with the applicable regulations. The Flexible connection pipe 20 x 3.4 mm can be used for this. We recommend fastening the connecting pipes with black plastic fastening clamps in accordance with our specifications. (aquatherm black installation principles).

#### 5. Mounting ceiling system with insert panels

The insertion battens must be installed in accordance with the provisions of DIN 18180. It must be ensured that the grids are filled with water (or the corresponding medium) during installation of the ceiling tiles and are under system pressure.

Any insulation required in accordance with fire protection or sound insulation requirements should also be installed.

#### Notes:

The use of mineral fibre boards leads to a reduction in heating and cooling performance.

The material for the substructure and the building boards must be provided by the customer.

### Detail: Connection pipework between the grids

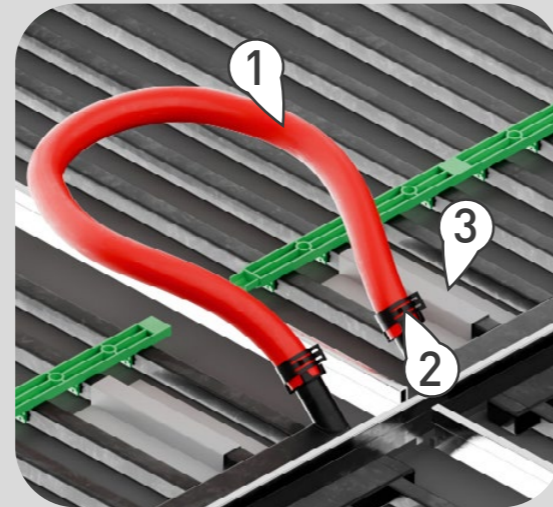

1. Flexible connection pipe (art. no. 4110020001)
2. Spring band clamp (art. no. 9600081074)
3. Heat conduction module (art. no. 9700081284)

### Section: Fixing the ceiling grid

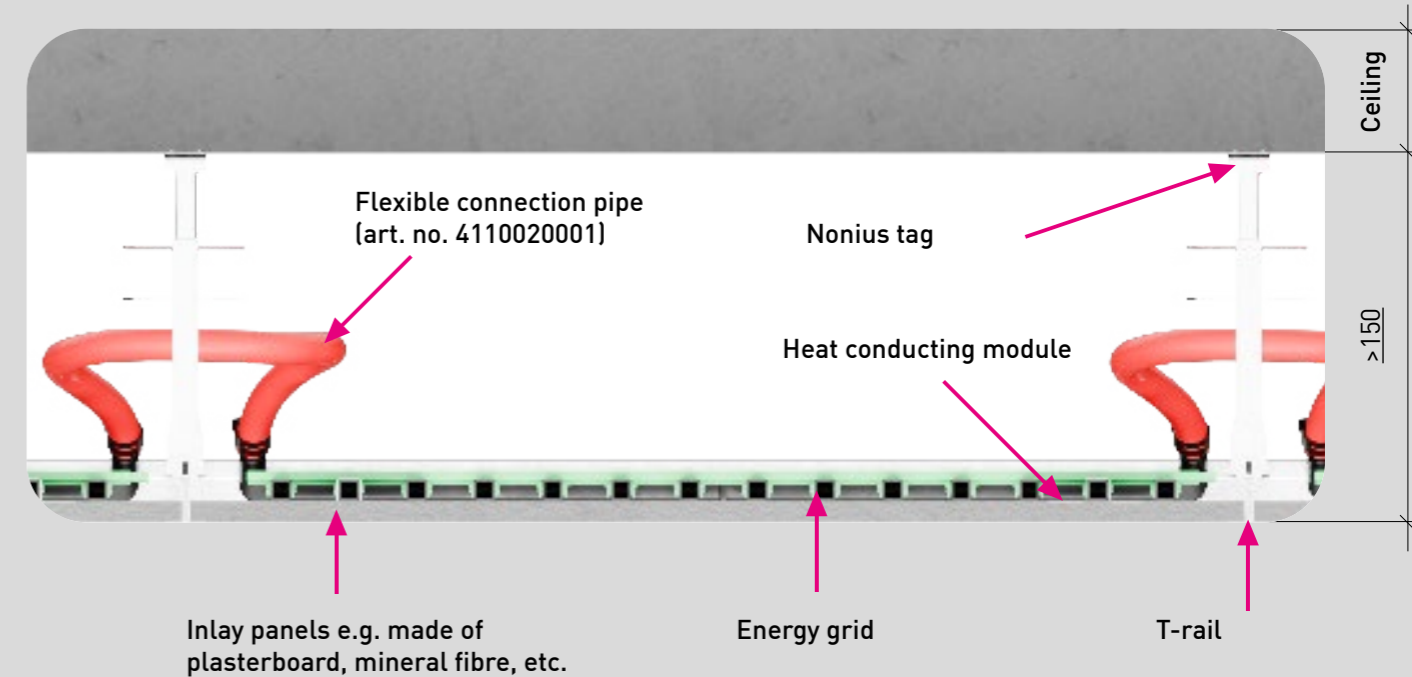



## Ceiling system: Drywall grid with insert panels made of plasterboard or mineral fibre

### ASSEMBLY DESCRIPTION

**Grid with push-fit connection  
45° top left, bottom right (mutual)**

CONNECTION TYPE 44

#### 1. Substructure (on site)

The substructure must be installed in accordance with the recognised rules of technology, generally applicable standards and regulations and the manufacturer's instructions. The substructure must be installed in accordance with the provisions of DIN 18168 and DIN EN 13964. Care must be taken to ensure horizontal and aligned installation. To ensure smooth installation of the grids, the clear suspended height must be at least 150 mm.

#### 2. Installation of the aquatherm black energy grid

To ensure a smooth installation process, the centre suspension height of the metal ceiling should be at least 150 mm.

#### 3. Connection of the aquatherm black energy grid

The grids for installation in a ceiling system for insert panels are equipped with a **45° push-fit connection (top left, bottom right - mutual)**.

After mounting the grids on the insert plates, they are connected to each other to form heating or cooling zones according to the assembly plan.

#### Notes:

The grids are placed on the insert panels according to the installation plan and fixed in place using heat conducting modules (100 mm aluminium sheet strips). Depending on requirements, mineral wool insulation (min. 30 mm, shrink-wrapped in PE film) can be placed on the grids.

Mounting with heat conducting modules	
Grid	Heat conducting modules
1m <sup>2</sup>	12

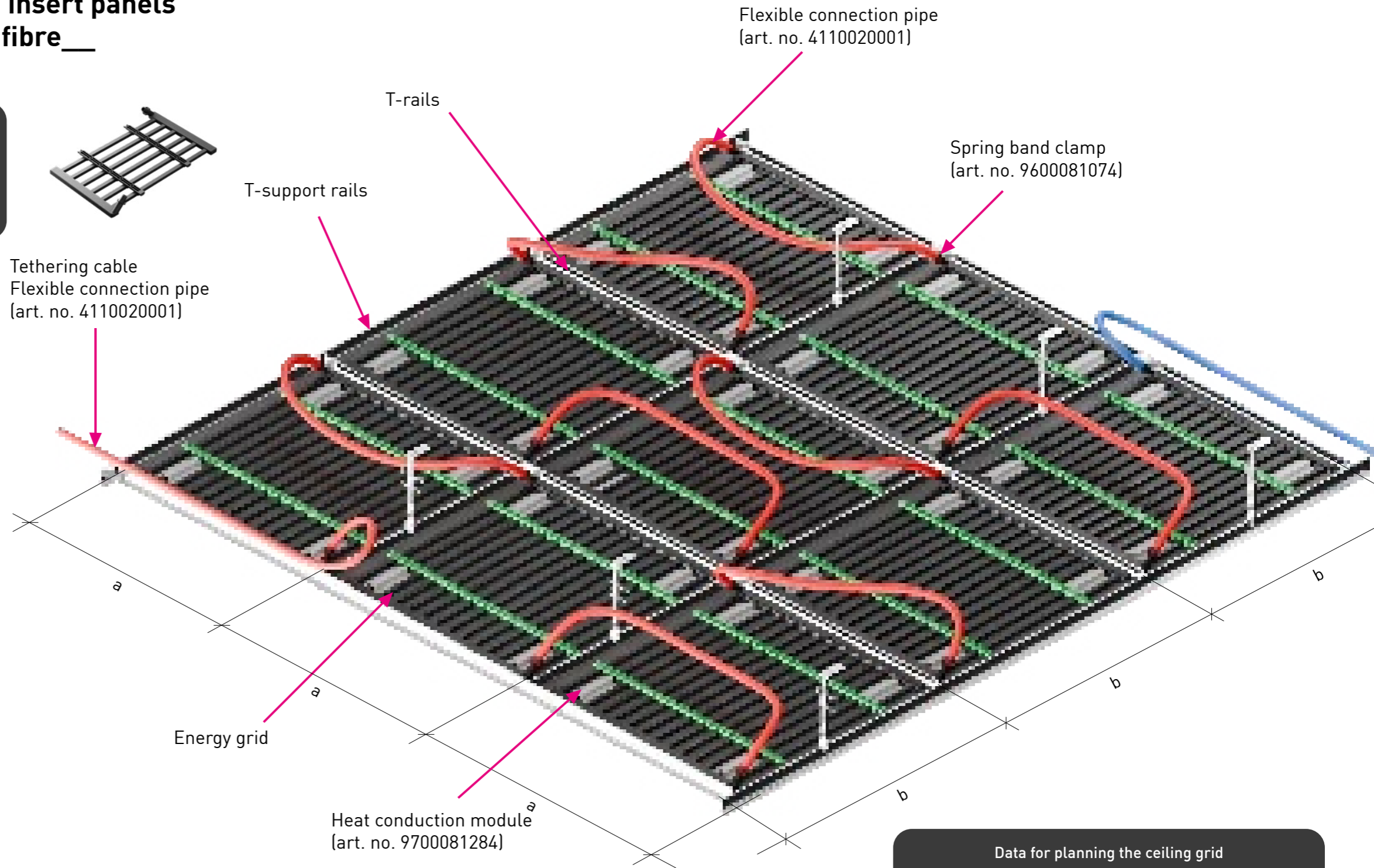

Data for planning the ceiling grid		
Dimensions of construction panel in mm		Grid in mm
a	b	-
600	600	560 x 580
625	625	560 x 600
600	1200	560 x 1180
625	1250	560 x 1200
Spacing of the substructure according to manufacturer's instructions		
Special solutions on request		





## Ceiling system: Drywall grid with insert panels made of plasterboard or mineral fibre

### ASSEMBLY DESCRIPTION

Grid with push-fit connection  
45° top left, bottom right (mutual)

CONNECTION TYPE 44

#### 4. Connection pipework of the aquatherm black energy grid to the distribution system

The connection of the heating/cooling circuits from the manifold or the main pipework is routed into the room, e.g. through the floor/wall/ceiling, in accordance with the applicable regulations. The Flexible connection pipe 20 x 3.4 mm can be used for this. We recommend fastening the connecting pipes with black plastic fastening clamps in accordance with our specifications. (aquatherm black installation principles).

Common variants of the hydraulic connection of heating and cooling elements are the classic pipework as a zone, as a Tichelmann and the pipework via a manifold.

#### 5. Mounting ceiling system with insert panels

The insertion panels must be installed in accordance with the provisions of DIN 18180. It must be ensured that the grids are filled with water (or the corresponding medium) during installation of the ceiling tiles and are under system pressure.

Any insulation required in accordance with fire protection or sound insulation requirements should also be installed.

#### Notes:

The use of mineral fibre boards leads to a reduction in heating and cooling performance.

The material for the substructure and the building boards must be provided by the customer.

### Detail: Connection pipework between the grids

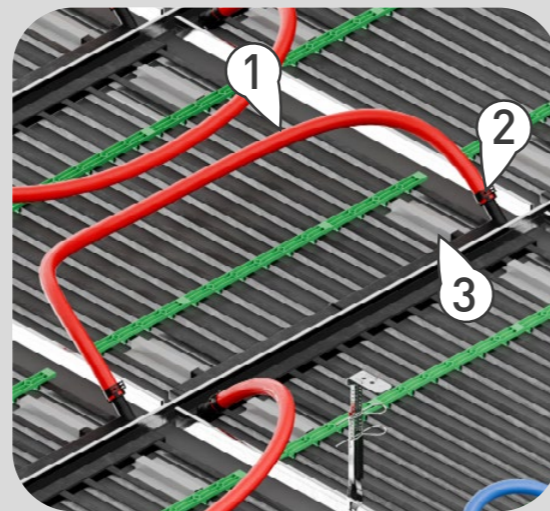

1. Flexible connection pipe (art. no. 4110020001)
2. Spring band clamp (art. no. 9600081074)
3. Heat conduction module (art. no. 9700081284)

### Section: Fixing the ceiling grid

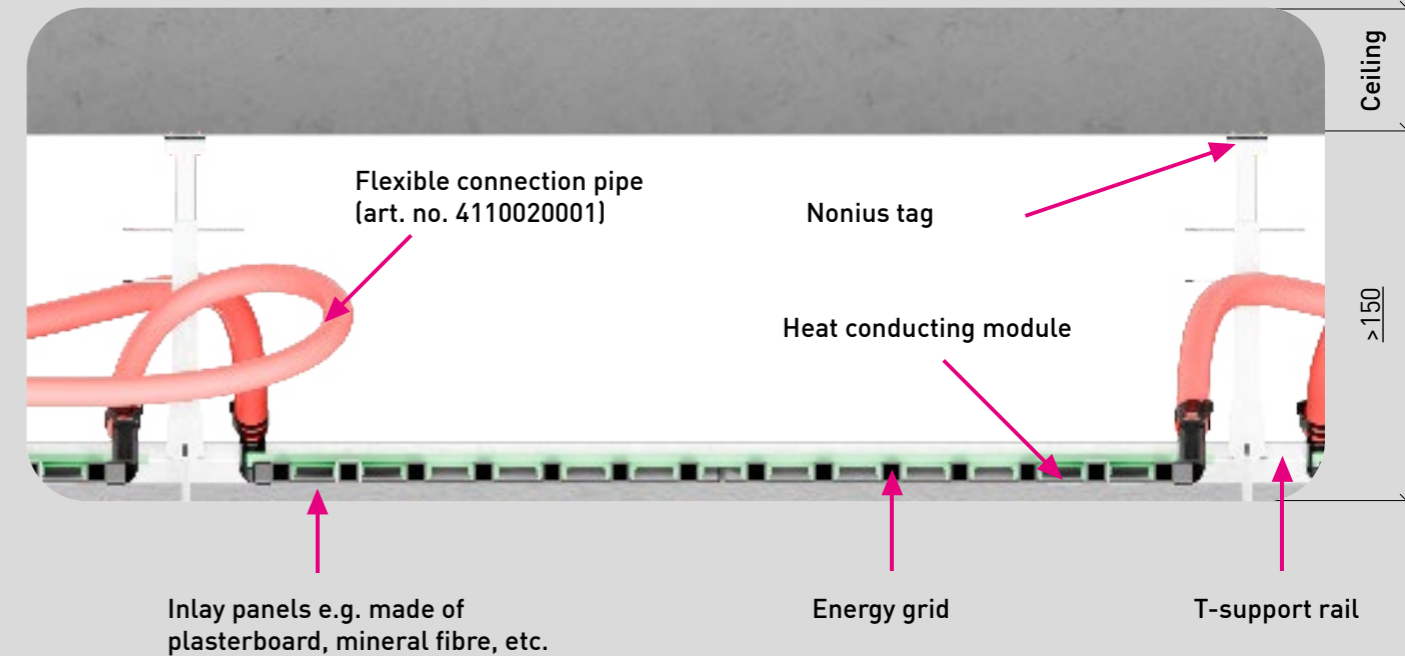



## Grid fastening via heat conducting modules \_\_\_

The aquatherm black grids are inserted into the metal ceiling panels and then fixed and fastened using heat conducting modules (100mm mat. no.: 9700081284).

The aquatherm black grids can be ordered and delivered pre-assembled at the factory; including metal cassette and heat conducting modules.

When installing the modules yourself, make sure that the surface is free of dust and dirt. There are two protective strips on the back of the heat conducting modules. These must be removed and the heat conducting module is pressed over the capillary tube of the grid and fixed to the base of the cassette.

It is important for self-assembly that the heat conducting modules are constantly pressed against the substrate.

Further recommendations:

- Pre-assembly at working height
- Pre-assembly of a connection

(Flexible connection pipe and spring band clamp)

The metal ceiling panels must always be fixed with at least three heat conducting modules.

Whether additional heat conducting modules are required for fastening depends on the dimensions of the metal ceiling panel and the maximum distance between the heat conducting modules.

In order to achieve optimum performance, the number of heat conducting modules should be taken from the table (see also "Performance diagrams").

In addition, the metal cassettes must be closed after installation until final moulding.



This type of fastening is used with the following aquatherm systems:

- Drywall grid with insert panels
- Thermally activated ceiling sails
- Metal cassettes (clamping/hanging system)
- Metal cassette with tape grid system
- Metal cassette with expanded metal

Closed ceiling systems	
Grid	Heat conducting modules
1m <sup>2</sup>	12

Sail systems	
Grid	Heat conducting modules
1m <sup>2</sup>	7





## aquatherm black high-performance modules as hcm \_\_\_

The aquatherm black high-performance modules can be used as a heating and cooling system. Their surface temperature is only a few degrees above or below the desired room temperature. The even transfer of heat or cold by means of radiation ensures increased comfort. In addition, there are no draughts or dust turbulence, as is the case with air conditioning systems.

The grids are installed in the factory with aluminium heat conducting plates in metal cassettes. The activated metal cassettes are delivered directly to the construction site. The finished metal cassette elements only need to be hooked into the corresponding substructure and hydraulically connected to each other.

The system utilises the pressure drop and flow advantages of the grids as well as the excellent thermal conductivity of the aluminium. The full-surface bonding guarantees quick and easy installation in various ceiling systems. Thanks to reduced connection technology, installation times and costs per square metre of installed ceiling are reduced.

Grid with push-fit connection 45° left, right (one-sided) Connection: 43

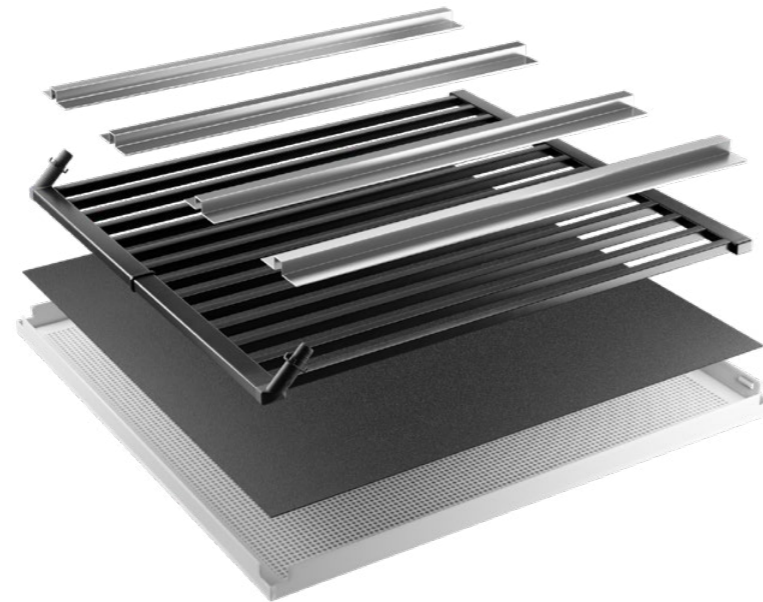

- 1. Heat conducting modules
- 2. Energy grid
- 3. Acoustic fleece
- 4. Metal cassette

Grid with push-fit connection 45° left, right (mutual) Connection: 44

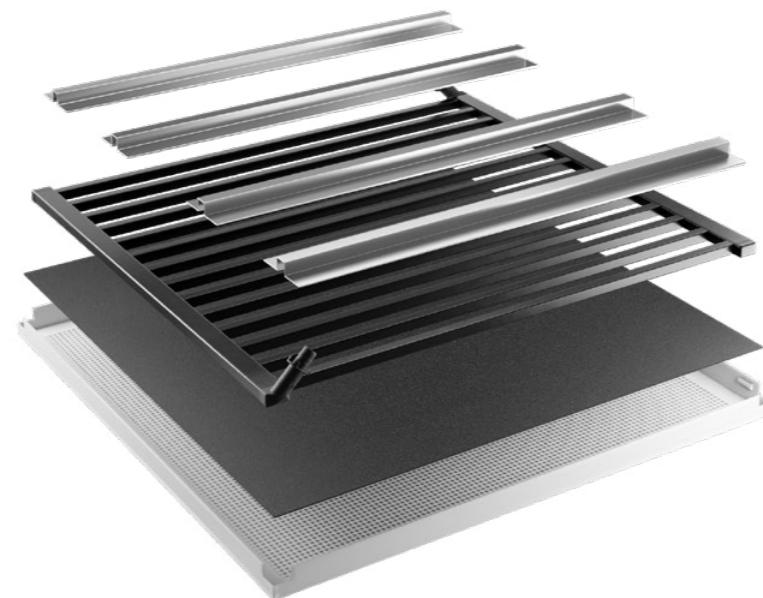

- 1. Heat conducting modules
- 2. Energy grid
- 3. Acoustic fleece
- 4. Metal cassette

Grid width (mm)	Total module width (mm)
240	265
280	305
320	345
360	385
400	425
480	505
520	545
560	585
600	625
Special dimensions on request	



## Grid fastening via spray adhesive

Another option for fixing the aquatherm black grid is to apply spray adhesive.

In preparation, both the substrate of the metal cassette and the grid should be free of dirt and dust. The aquatherm black grid is positioned with the connections facing the substrate.

The spraying distance should be approx. 15-25 cm.

Allow to flash off for between 5-15 minutes (depending on temperature, material and application) and join together.

**Recommendation:** WÜRTH - SPRAY ADHESIVE PLUS

Contact adhesive with high instant tack and high temperature resistance

- Chemical basis: Synthetic rubber
- Odour/scent: Characteristic
- Processing temperature min./max.: 0 to 30 °C
- Temperature resistance min./max.: -20 to +110 °C
- Minimum flash point: -24 °C
- Flash-off time min./max.: 5 min-15 min
- Spray distance min/max: 15-25 cm
- Shelf life from production: 12 months
- Silicone free: Yes

Further information can be found in the technical data sheet.







## Grid fastening with magnetic holder

The aquatherm black grids are inserted into the metal ceiling panels and then secured with the hold-down magnets.

The metal ceiling tiles must always be fixed with at least three hold-down magnets. Whether additional magnets are required for fastening depends on the dimensions of the metal ceiling panel and the maximum distance between the magnets.

Maximum distance between magnets: 800 mm

### Detail: Grid fastening with magnetic holder

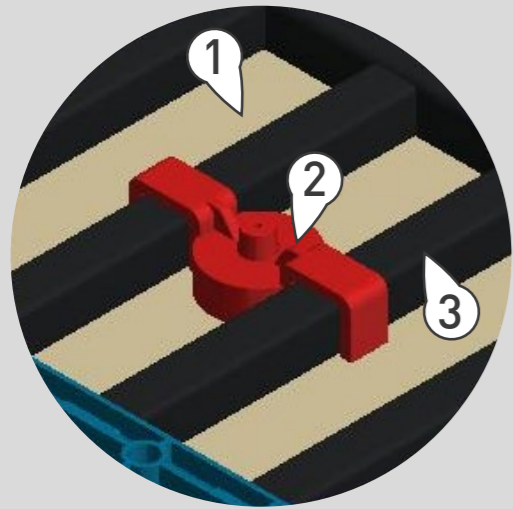

- 1. Acoustic fleece
- 2. Magnetic holder (art. no. 9700081286)
- 3. Grid



No. of magnets per m <sup>2</sup>	Grid area per m <sup>2</sup>
3	from 0.00 to 0.50 m <sup>2</sup>
4	from 0.51 to 1.00 m <sup>2</sup>
5	from 1.01 to 5.00 m <sup>2</sup>



**Alternative mounting for aquatherm black system plastered into the wall and ceiling with the battery-operated HILTI BX 3-ME mounting device**

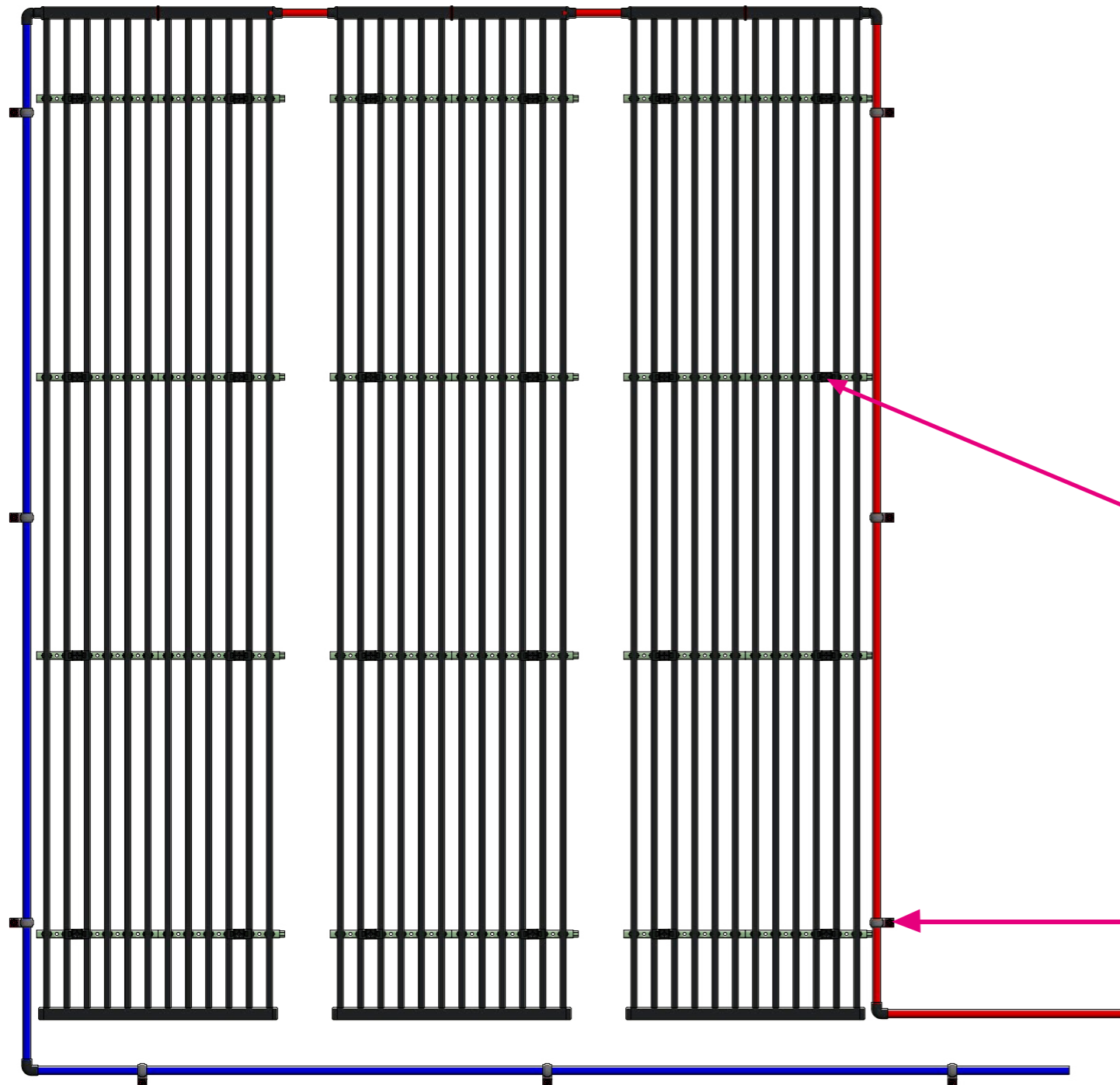

**Applications / Advantages**

- Quick installation compared to standard fastening (drilling with fastening element and dowel)
- Major cost savings on materials
- Quick and easy installation on all suitable substrates, such as solid brick or concrete
- Versatile fastening system for various applications in the heating and sanitary sector
- High user comfort due to low contact pressure and less noise and regrid
- For placing up to 600 fastenings with just one battery charge

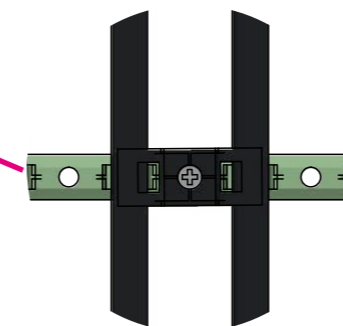

**Fastening the grids**

aquatherm recommends the installation of 8 fastening elements (art. no. 4050000013 from aquatherm) with the Hilti universal nail type X-P 30 B3 P7 per 1 m<sup>2</sup> of grid surface.

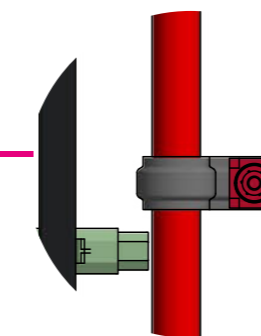

**Fastening the connection pipework**

Fastening of the connection pipework exclusively with fastening element type Fixbride X-FB 20 MX from Hilti.

Mounting the fastening element with Hilti nail type X-P 24 B3 MX.





## Ceiling system: Drywall grid with insert panels made of plasterboard or mineral fibre

Installation examples of further insert panels for standard T-rails:

Ceiling systems based on a drywall grid consist of a suspended substructure into which surface-finished inlay panels made of plasterboard or mineral fibre are inserted.

Numerous versions and designs (from various manufacturers) are available for the respective visual and acoustic requirements. These must be provided by the customer.

The aquatherm black energy grids for heating and cooling are glued to the insert plates.

Direct contact between the grids and the insert plates ensures good power transmission.



Installation examples of further insert panels for standard T-rails:

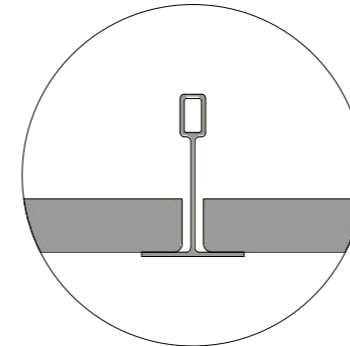

Flat insert

The insert elements with a flat insert usually consist of perforated plasterboard panels with an all-round unperforated edge, which are placed on the T-rails. This is visible and is emphasised by the slight overhang.

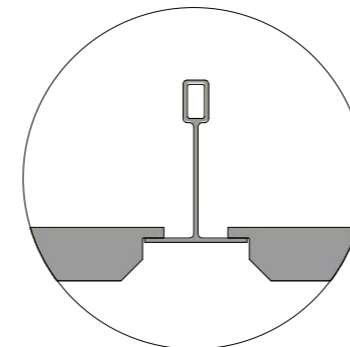

Deep embossing with bevelled edge

The inlay elements with deep embossing and bevelled edges are usually made of perforated plasterboard with an all-round unperforated edge. The units have a slightly bevelled visible edge with an all-round rebate. This results in an attractive appearance with recessed T-rails.

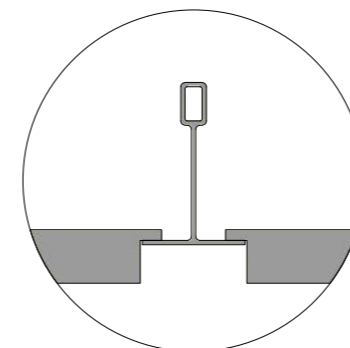

Deep embossing, sharp-edged

The insert elements with sharp-edged deep embossing usually consist of plasterboard panels perforated right up to the edge. A high-quality look with recessed T-rails results from the all-round rebate with an elegant, sharp visible edge.



## Ceiling system: Drywall grid with insert panels made of plasterboard or mineral fibre

Alternatively, the grid can be glued in on site.

The grid is bonded to the insert plate using a suitable contact adhesive. This method ensures very good heat transfer thanks to full-surface bonding.



Adhesives and solvents for gluing the aquatherm grids to the building boards can be obtained directly from the manufacturer Wakol GmbH.

The manufacturer's instructions must be observed:  
 Article description adhesive: L1720 RED  
 Article description solver: Solver 31

Design	Perforation	Perforation [plate] %	Weight kg/m <sup>2</sup>
Round perforation	Ø 6	10,5	8,2
Square perforation	9x9	16,3	8,1
	12x12	12	8,1
Slot	4x14	21,1	8,1
Scatter perforation	Ø 8/15/20	10,8	8,2
unperforated	-	0	9,9

Note: Rated weight for larger panel thicknesses and/or other panel types on request

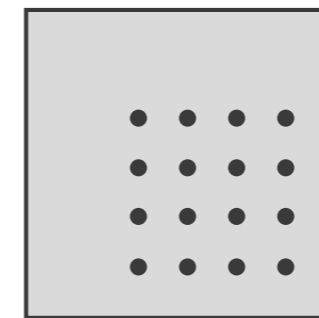

Round perforation 6

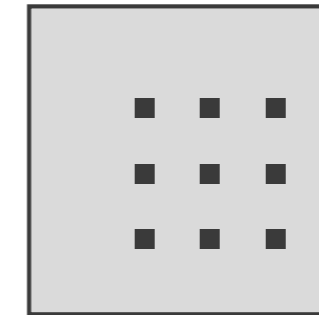

Square perforation 9 x 9

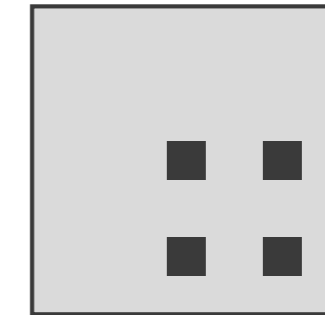

Square perforation 12 x 12

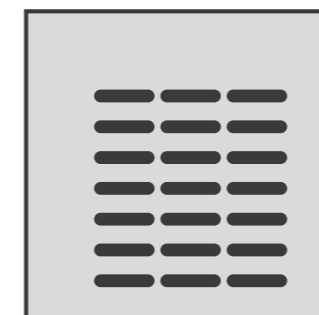

Slots 4 x 14

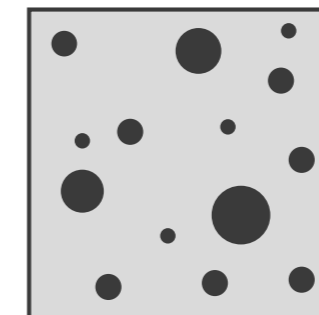

Scatter perforation 8/15/20

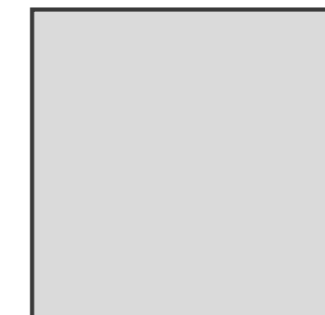

Unperforated





## Ceiling system: Plastered in \_\_

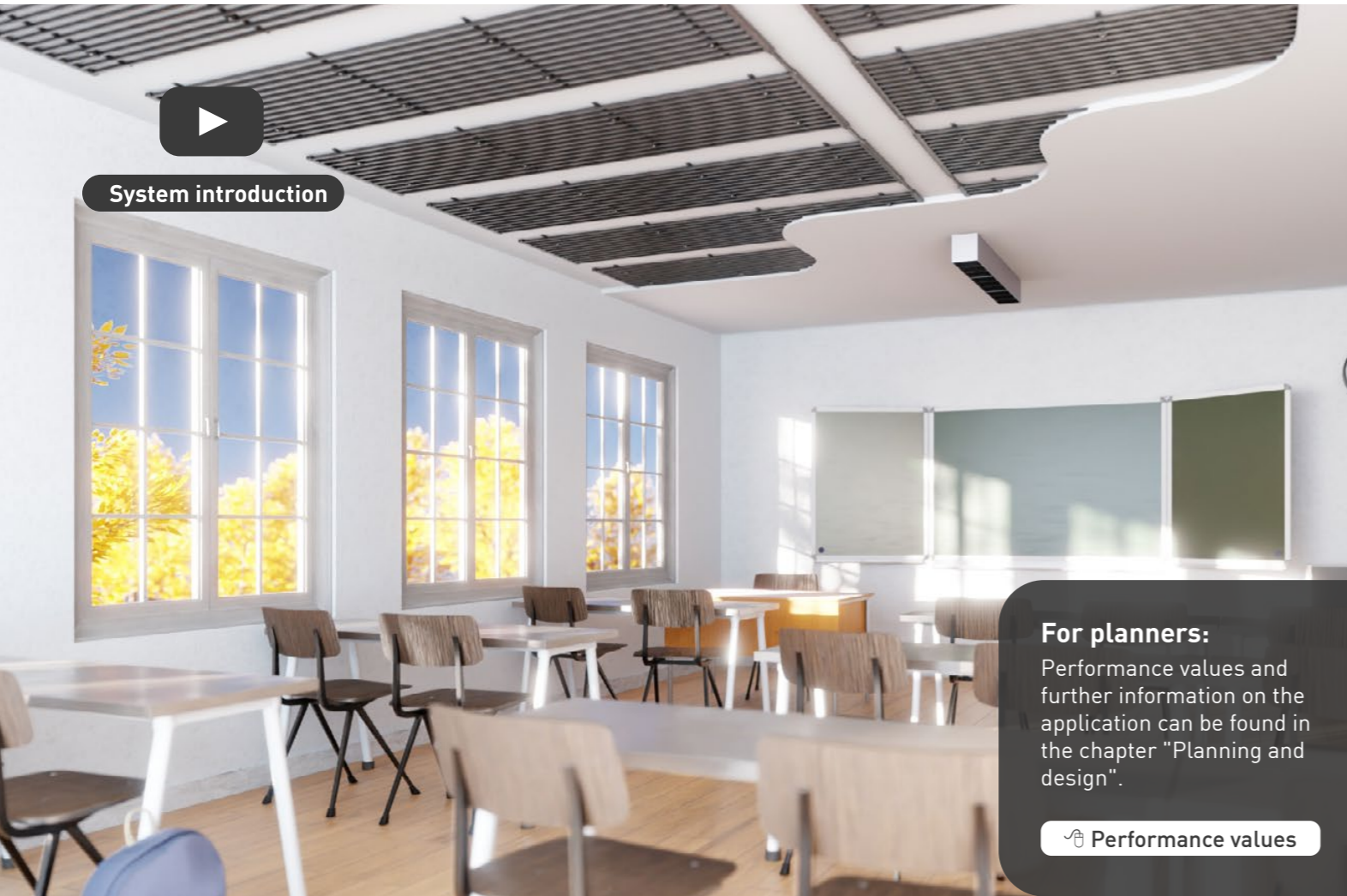

### For planners:

Performance values and further information on the application can be found in the chapter "Planning and design".

[Performance values](#)

### Advantages:

- High heating and cooling capacities thanks to the large thermal transfer surface of the square-edged grid profiles.
- Silent, draught-free heating and cooling function.
- Efficient use of heat pumps and renewable energies.
- Short heat-up and fast response times.
- Quick and easy attachment.
- Pleasant room climate.
- Can be installed on many ceiling surfaces.

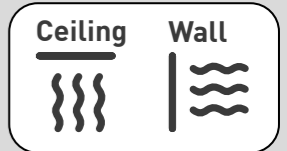

### System description

The design freedom is a major advantage here: the aquatherm black heating and cooling grids can be customised in shape and dimensions to suit any room geometry. The heating and cooling grids and the connection pipework are attached to the ceiling or wall. Plastering is then carried out in accordance with the general plastering guidelines. All commercially available plasters made of gypsum, lime, cement and clay are suitable for this.



## Ceiling system: Plastered in \_\_\_

### ASSEMBLY DESCRIPTION

**Grid with welded connection**  
**Socket left, right (one-sided)**

CONNECTION TYPE 45



#### 1. Requirements for the substrate

To prepare the substrate, we recommend using a suitable primer to create a non-slip substrate in accordance with the manufacturer's instructions. Furthermore, the substrate must be dust-free, free of loose particles, oil, grease, formwork release agents and post-treatment agents, sintered layers, soiling and harmful efflorescence and meet the requirements for the evenness of component surfaces in accordance with DIN 18202.

#### 2. Installation of aquatherm heating and cooling grids

The grids are fastened to the bare ceiling using the supplied fastening elements with dowels in accordance with the installation plans. The fastening element is attached to the bare ceiling using the fastening rail mounted on the grid.

We recommend using at least 8 fastening elements with dowels per m<sup>2</sup> of grid surface. Please note the following:

Depending on the plaster substrate, type and manufacturer, the fixing element with dowels can be used as a plaster base in conjunction with the fixing rail during ceiling installation. Additional plaster base supports (reinforcing mesh) in the area of the grids can be omitted. However, it must be ensured that the necessary measures are taken in the plaster areas without grids.

For ceiling heating and cooling systems, the use of plaster supports for additional fastening and installation has proven its worth. Plaster bases must be fixed to the surface at a grid spacing of 500 mm. In exceptional cases, depending on the geometry of the reinforcing mesh, grid spacings of 400x600 mm can also be used for plaster bases in ceiling heating and cooling systems. The distance to boundary components or edge surfaces must not exceed 250 mm. The plaster manufacturer's processing guidelines are binding and must be observed!

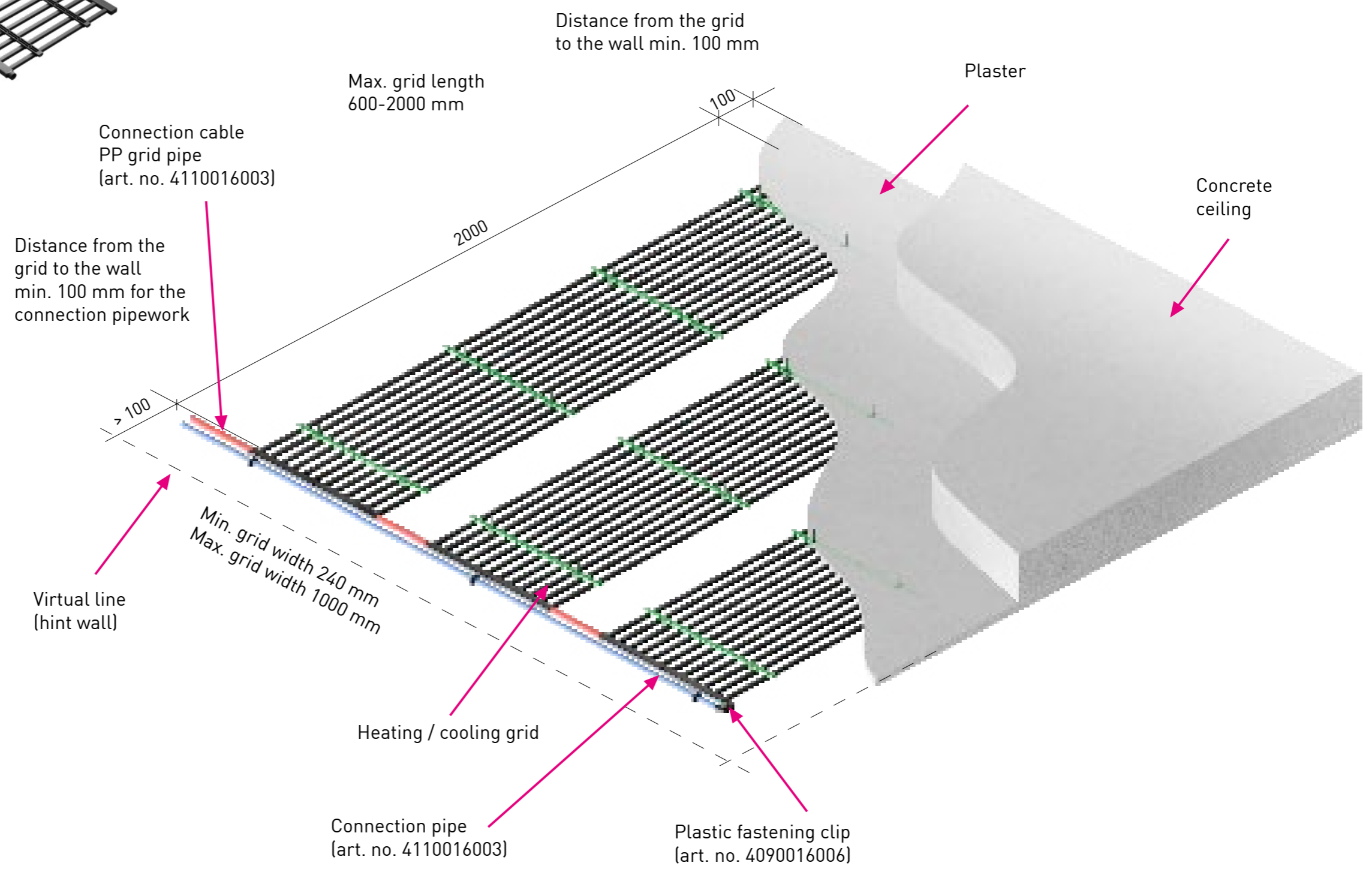

**Special dimensions on request**





## Ceiling system: Plastered in \_\_\_

### ASSEMBLY DESCRIPTION

#### Grid with welded connection Socket left, right (one-sided)

CONNECTION TYPE 45

#### 3. Connection of the aquatherm black Heating and cooling grid

When arranging the grids, the flow can be connected either on the left or right. The grids for installation in a ceiling system with plaster are fitted with welding sockets (welding connection socket left, right). After installing the grids on the bare ceiling, they are connected to each other to form heating or cooling zones in accordance with the installation plan.

#### 4. Connection pipework of the aquatherm black heating and cooling grid to the distribution system

The heating or cooling circuits are connected to the manifold or the main pipework using aquatherm black 16x2 mm grid pipe. This can be plastered in if it has also been fastened to the bare ceiling (e.g. with aquatherm black plastic fastening clips).

Alternatively, we recommend fastening the grids and connecting cables with a bolt fastening device.

#### 5. Plastering the aquatherm heating and cooling grids

The ceiling can now be pre-plastered up to the top edge of the grid. After the drying times specified by the manufacturer, the plaster covering (max. 10 mm) can be applied from the top edge of the heating pipe (in accordance with the manufacturer's instructions). It must be ensured that the grids are filled with water (or the corresponding medium) during plastering and are under system pressure. The aquatherm plastering guidelines must also be observed.

#### Detail: Fixing the ceiling grid

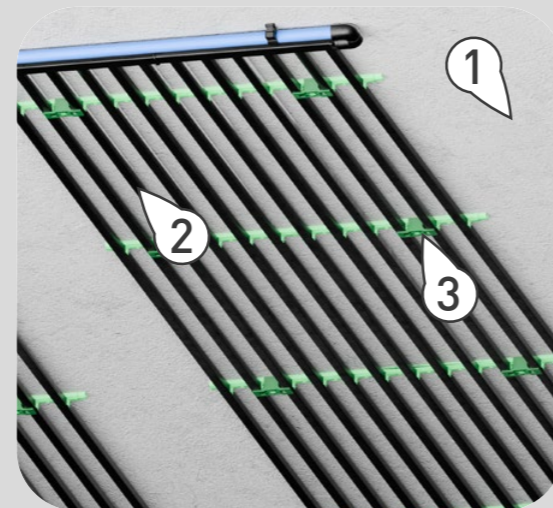

1. Concrete ceiling
2. Heating and cooling grid
3. Fastening element with dowels (art. no. 4050000013)

#### Detail: Fastening of the connection pipework

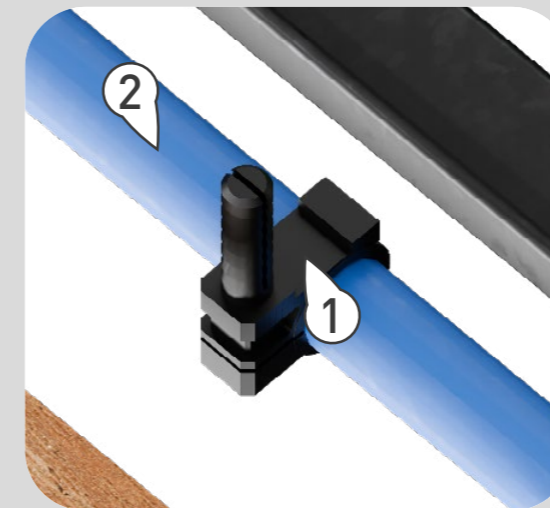

1. Plastic fastening clip (art. no. 4090016006)
2. Connection pipework (art. no. 4110016003)

#### Detail: Fixing the ceiling grid

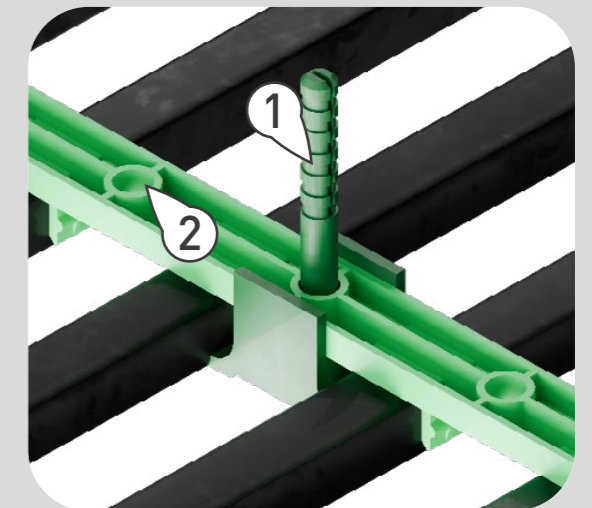

1. Fastening element with dowel (art. no. 4050000013)  
Recommendation: 8 pieces per m<sup>2</sup> active area
2. Mounting rail

#### Notes:

Depending on the application of the plaster, the manufacturer may specify a ceiling primer, the use of plaster pins or the application of plaster bases. The respective plaster manufacturer should be consulted on this.

The plastering material and the associated accessories are to be provided by the customer.

#### Section: Fixing the ceiling grid

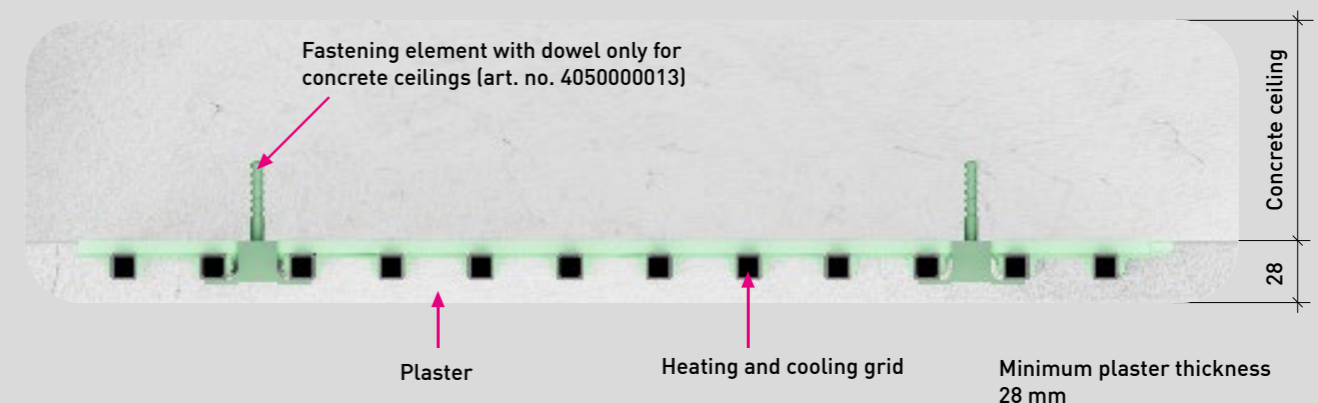



## Ceiling system: Thermally activated ceiling panels \_\_\_

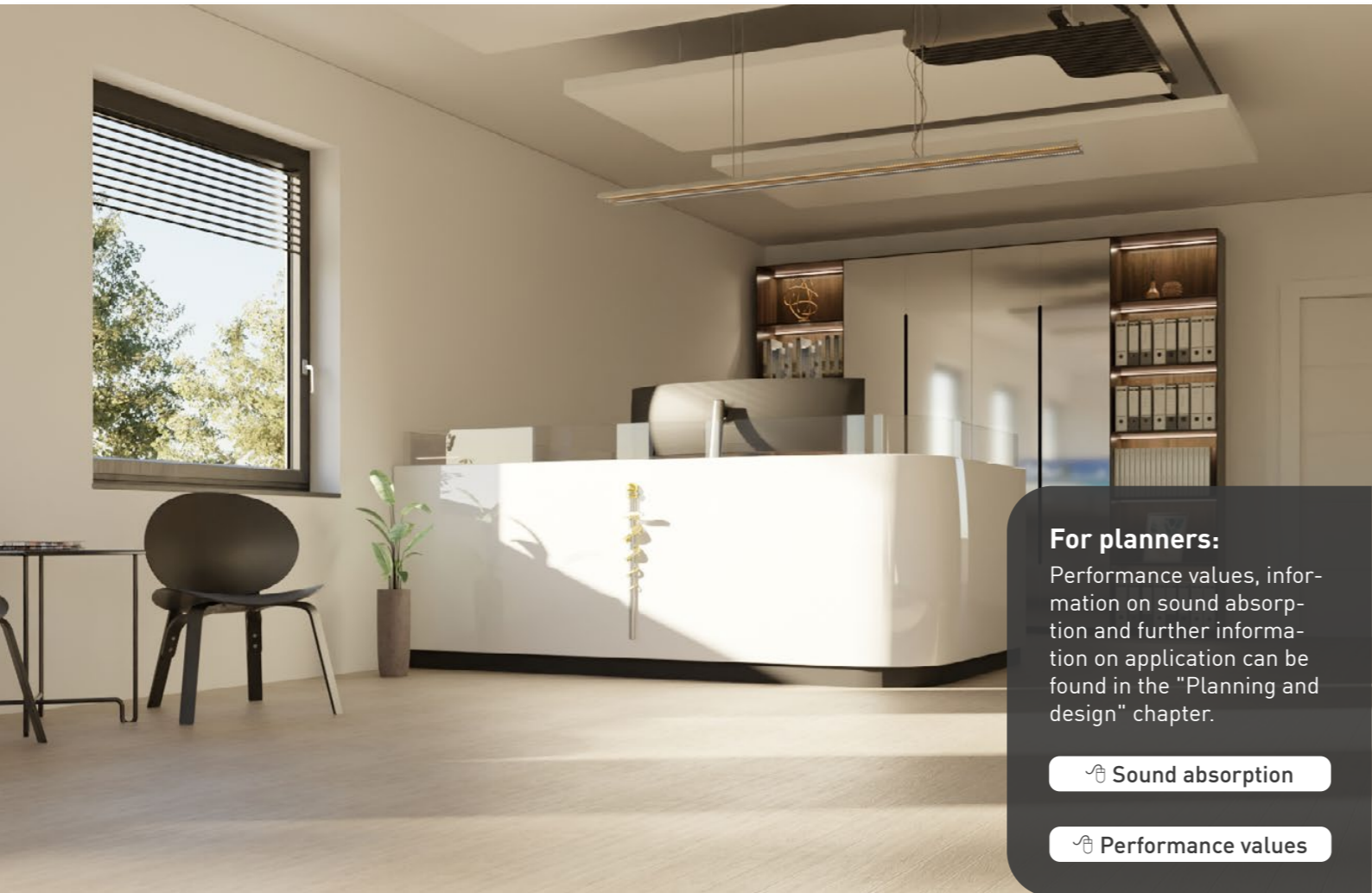

### For planners:

Performance values, information on sound absorption and further information on application can be found in the "Planning and design" chapter.

 [Sound absorption](#)

 [Performance values](#)

### Advantages:

- High heating and cooling performance due to excellent contact transfer surface.
- Factory prefabricated grid modules for quick installation on site.
- Quick and easy installation thanks to fixing via heat conducting modules.
- Increased performance through heat conducting modules.
- Combination with centrally treated outside air possible.
- System can be retrofitted into existing metal ceiling systems.
- High sound absorption with metal ceiling tiles with micro-perforation.
- Silent and invisible heating and cooling function.

Ceiling

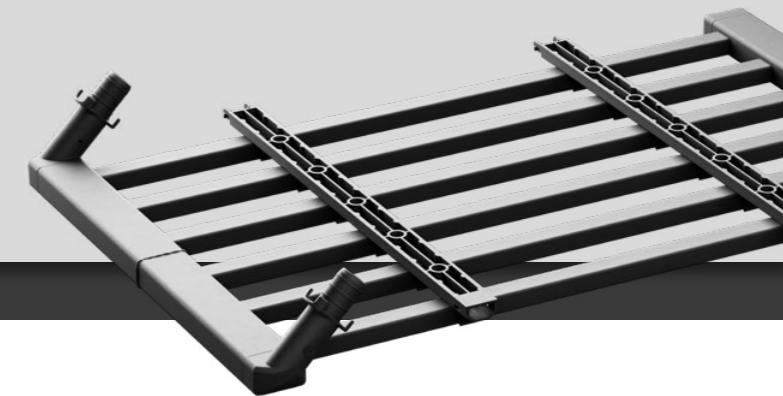

### System description

Metal ceiling sails offer architects and planners the greatest possible design freedom: Both the sails and the aquatherm black energy grids can be customised in shape and dimensions to suit any room geometry. aquatherm black energy grids are ideal for distributing heat or cold quickly and evenly across a surface. An innovative material combines high thermal conductivity with minimum weight.





## Ceiling system: Thermally activated ceiling panels

### ASSEMBLY DESCRIPTION

#### Thermally activated ceiling sails - Push-in connection 45° left, right (one-sided)

#### CONNECTION TYPE 43

#### 1. Suspension of the ceiling sails

Ceiling sails are thermally conductive and connected to the bare ceiling by ceiling hangers. The total height incl. grid is at least 200 mm. The ceiling canopy is attached via at least 4 suspension points using metal dowels approved by the building authorities, suitable threaded rods or steel cables in accordance with the manufacturer's specifications and the structural requirements. Other suspension designs are possible using special hangers. The vertical or angled upstand of the ceiling sail and individual arrangement options in the room give you a wide range of design options.

#### 2. Installation of the aquatherm energy grid

Installation must be carried out in accordance with the recognised rules of technology, generally applicable standards and regulations as well as the manufacturer's instructions. For this purpose, the grids are placed in the ceiling sails according to the installation plan and fixed in place using heat conducting modules (100 mm aluminium sheet strips). Installation must be carried out in accordance with the provisions of DIN EN 13964. Ensure that the installation is level and flush.

#### 3. Connection of the aquatherm energy grids

The grids for installation in a ceiling canopy are supplied with a 45° push-fit connection (left, right - one-sided) with flow interruption. This ensures a uniform flow. Once the grids have been installed in the ceiling canopy on the ceiling, they are hydraulically connected to form heating or cooling zones in accordance with the installation plan. The Flexible connection pipe 20 x 3.4 mm with our spring band clamps is used for this (see connection detail).

#### Notes:

Depending on requirements, mineral wool insulation (min. 30 mm, shrink-wrapped in PE film) can be placed on the grids.

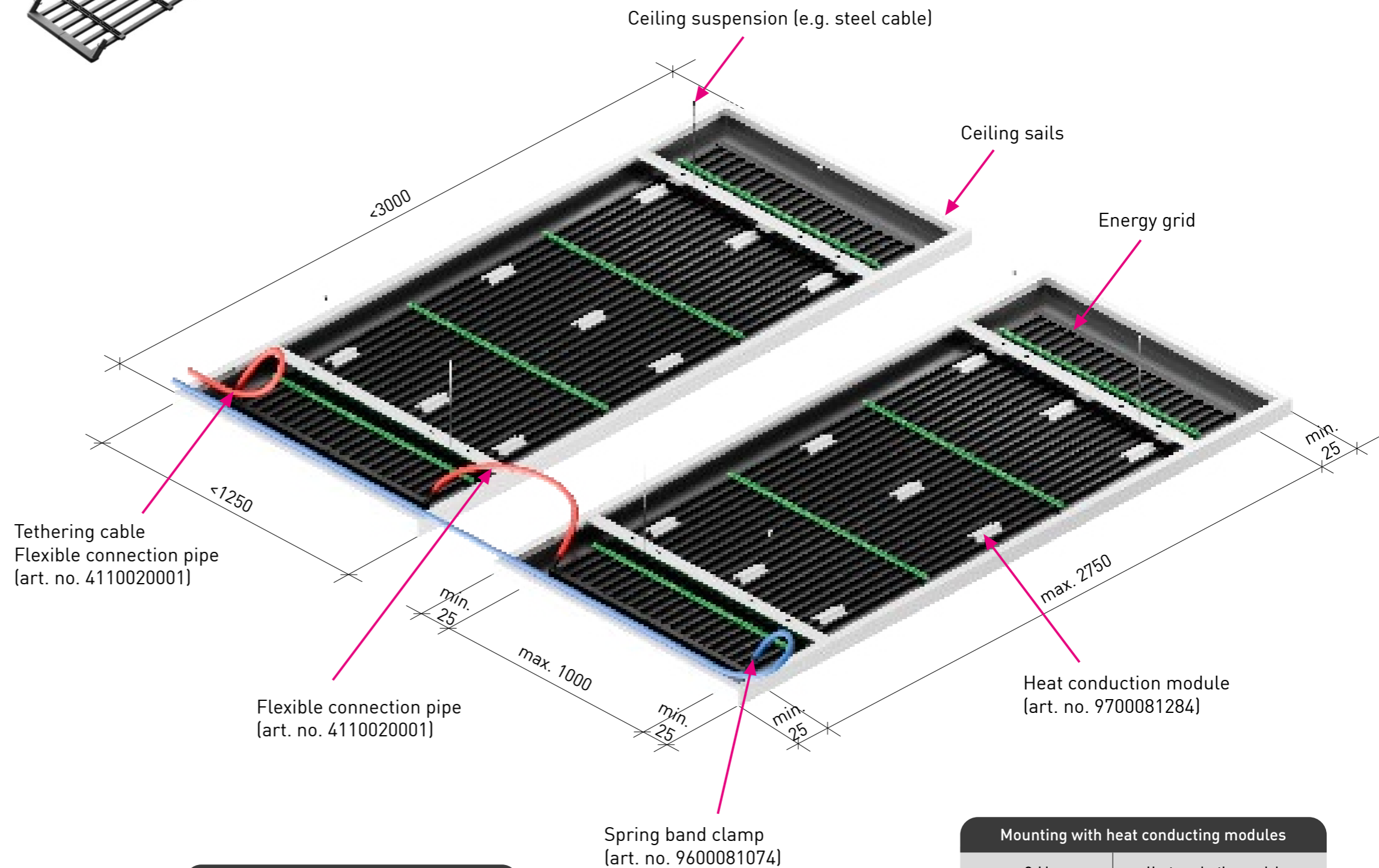

Special dimensions on request

#### Mounting with heat conducting modules

Grid	Heat conducting modules
1 m <sup>2</sup>	7



## Ceiling system: Thermally activated ceiling panels \_\_\_

### ASSEMBLY DESCRIPTION

#### Thermally activated ceiling sails - Push-in connection 45° left, right (one-sided)

#### CONNECTION TYPE 43

#### 4. Connection pipework of the aquatherm black energy grid to the distribution system

The connection of the heating/cooling circuits from the manifold or the main pipework is routed into the room, e.g. through the floor/wall/ceiling, in accordance with the applicable regulations. The Flexible connection pipe 20 x 3.4 mm can be used for this. We recommend fastening the connecting pipes with black plastic fastening clamps in accordance with our specifications. Common variants of the hydraulic connection of heating and cooling elements are classic pipework as a zone, as a Tichelmann and pipework via a manifold. It must be ensured that the grids are filled with water (or the corresponding medium) and are under system pressure during the installation of the construction panels.

#### Notes:

The material for the substructure and the ceiling sails must be provided by the customer. It must be ensured that the grids are filled with water (or the corresponding medium) during installation of the ceiling sails and are under system pressure.

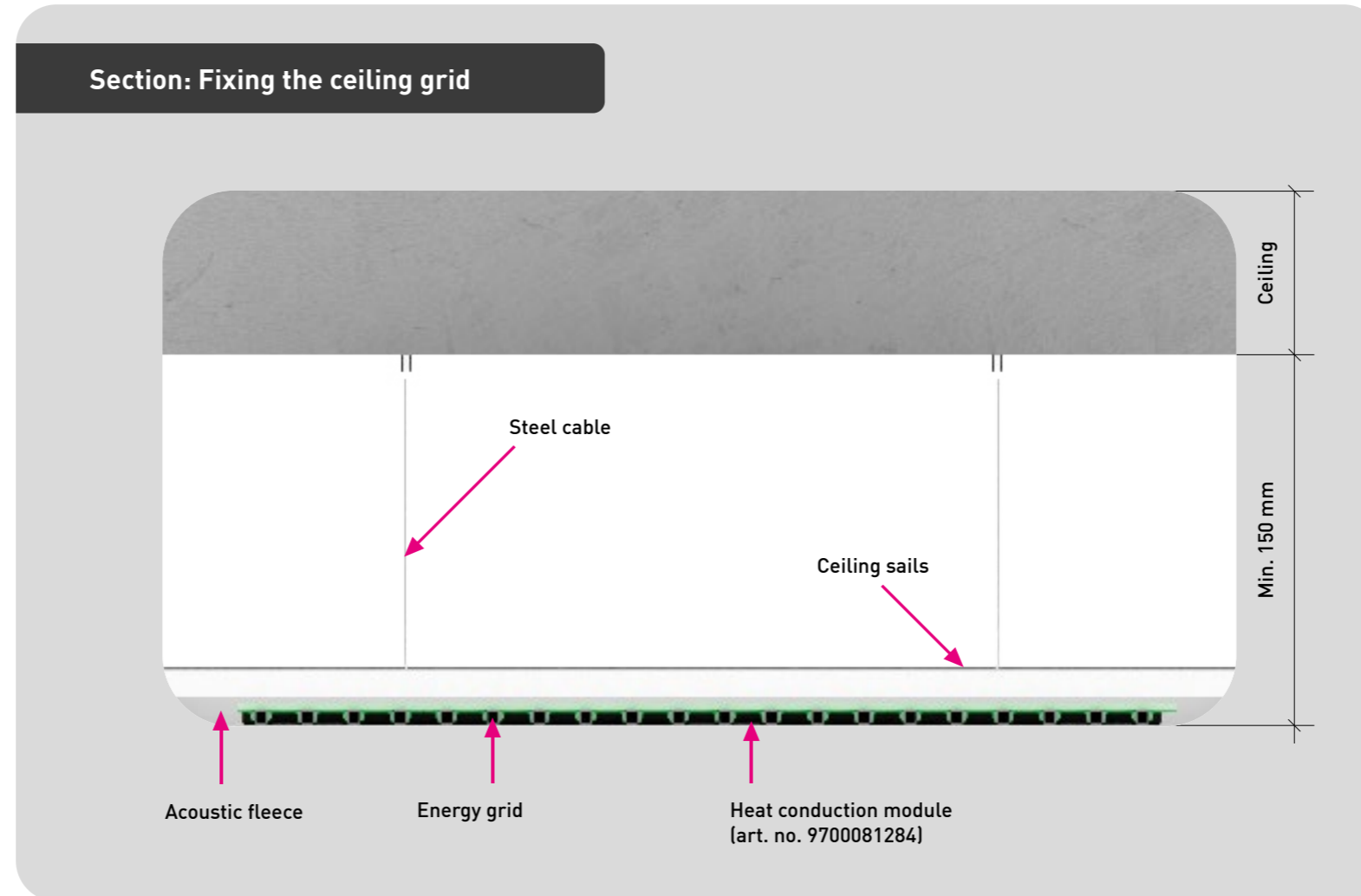

#### Detail: Connection pipework between the grids

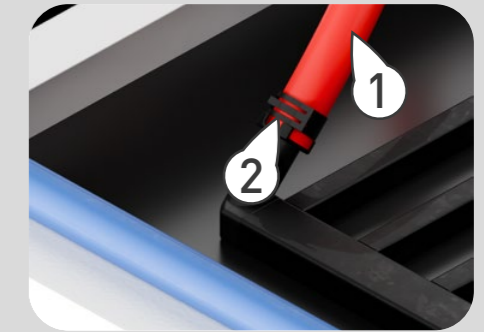

1. Flexible connection pipe (art. no. 4110020001)
2. Spring band clamp (art. no. 9600081074)

#### Detail: Fastening of the connection pipework

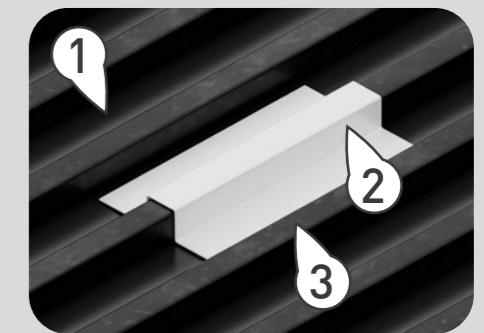

1. Acoustic fleece
2. Heat conduction module (art. no. 9700081284)
3. Energy grid





## Ceiling system: Metal cassette as clamping/hanging system \_\_

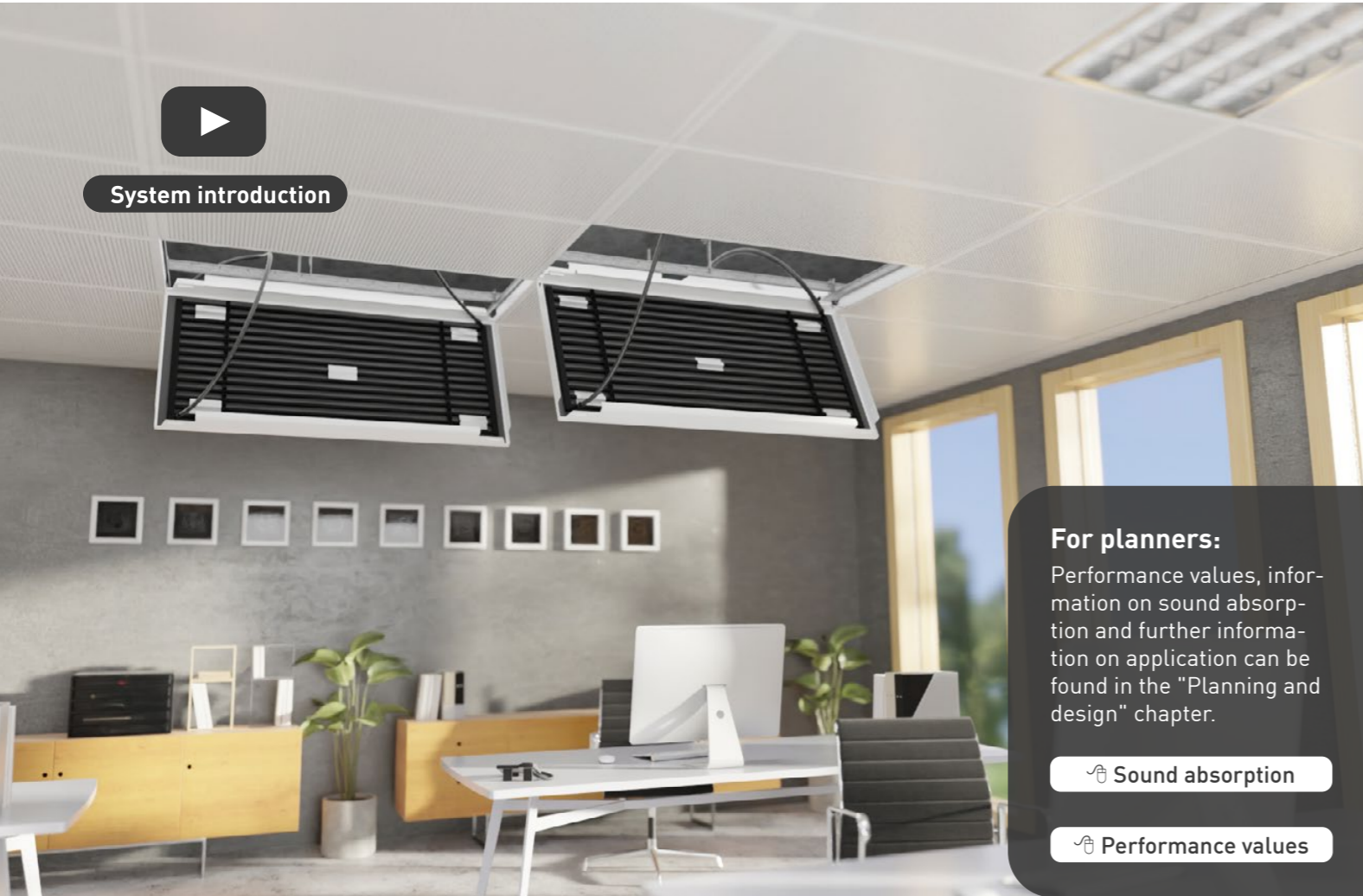

System introduction

### For planners:

Performance values, information on sound absorption and further information on application can be found in the "Planning and design" chapter.

 Sound absorption

 Performance values

### Advantages:

- High heating and cooling performance due to excellent contact transfer surface.
- Factory prefabricated grid modules for quick installation on site.
- Quick and easy installation thanks to fixing via heat conducting modules.
- Increased performance through heat conducting modules.
- Combination with centrally treated outside air possible.
- System can be retrofitted into existing metal ceiling systems.
- High sound absorption with metal ceiling tiles with micro-perforation.
- Silent and invisible heating and cooling function.
- Installation in combination with various ceiling installations/structures such as lights, fire alarms and ventilation components.
- Clear separation of the two trades: Building technology and ceiling construction.

Ceiling



### System description

The aquatherm black energy grids for heating and cooling are inserted into the metal clamping cassettes and fixed in place using heat conducting modules. Direct contact between the grids and the sheet metal or acoustic fleece ensures good power transfer.

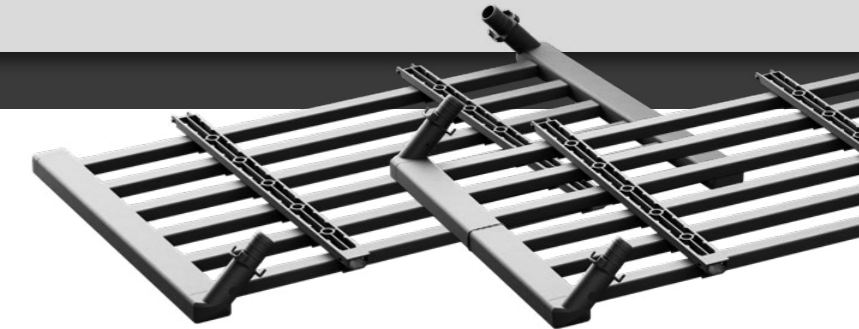



## Ceiling system: Metal cassette as clamping/hanging system

### ASSEMBLY DESCRIPTION

**Grid with push-fit connection  
45° left, right (one-sided)**

CONNECTION TYPE 43



### 1. Suspension of the ceiling sails

Ceiling sails are thermally conductive and connected to the bare ceiling by ceiling hangers. The total height including grid is at least 200 mm. The ceiling canopy is attached via at least 4 suspension points using metal dowels approved by the building authorities, suitable threaded rods or steel cables in accordance with the manufacturer's instructions and the structural requirements. Other suspension designs are possible using special hangers. The vertical or angled upstand of the ceiling sail and individual arrangement options in the room give you free design options.

### 2. Installation of the aquatherm energy grid

Installation must be carried out in accordance with the recognised rules of technology, generally applicable standards and regulations as well as the manufacturer's instructions. For this purpose, the grids are placed in the ceiling sails according to the installation plan and fixed in place using heat conducting modules (100 mm aluminium sheet strips).

Installation must be carried out in accordance with the provisions of DIN EN 13964. Ensure that the installation is level and flush.

### 3. Connection of the aquatherm energy grids

The grids for installation in a ceiling canopy are supplied with a **45° push-fit connection (left, right - one-sided)** with flow interruption. This ensures a uniform flow. Once the grids have been installed in the ceiling canopy on the ceiling, they are hydraulically connected to form heating or cooling zones in accordance with the installation plan. The Flexible connection pipe 20 x 3.4 mm with our spring band clamps is used for this (see connection detail).

### Notes:

Depending on requirements, mineral wool insulation (min. 30 mm, shrink-wrapped in PE film) can be placed on the grids.

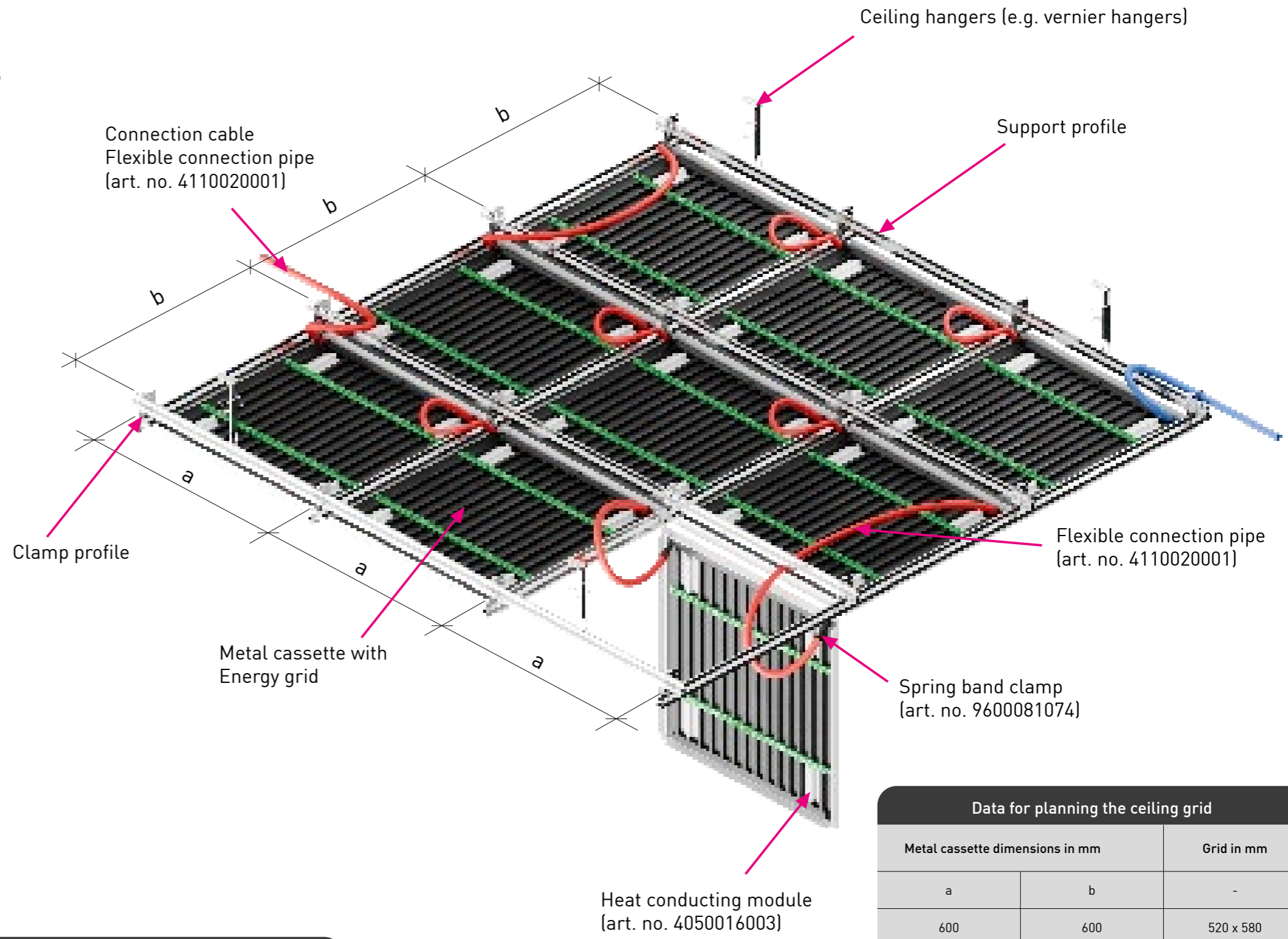

Mounting with heat conducting modules	
Grid	Heat conducting modules
1 m <sup>2</sup>	12

Data for planning the ceiling grid		
Metal cassette dimensions in mm		Grid in mm
a	b	-
600	600	520 x 580
625	625	560 x 600
Spacing of the substructure according to manufacturer's instructions		
Special solutions on request		





## Ceiling system: Metal cassette as clamping/hanging system

### ASSEMBLY DESCRIPTION

#### Grid with push-fit connection 45° left, right (one-sided)

CONNECTION TYPE 43

#### 4. Connection of the aquatherm energy grids

The grids for installation in the terminal cassettes are supplied with a 45° push-fit connection (left, right - one-sided) with flow interruption. This ensures a uniform flow. Once the grids have been installed in the ceiling canopy under the ceiling, they are hydraulically connected to form heating or cooling circuits in accordance with the installation plan. Common variants of the hydraulic connection of heating and cooling elements are classic pipework as a zone, similar to the Tichelmann system, and pipework via a manifold. The Flexible connection pipe 20 x 3.4 mm with our spring band clamps is used for this (see connection detail). Please note the length of the connecting pipework, 750 mm on one side and 1500 mm on the other, so that the cassettes can be opened easily in the specified folding direction.

#### 5. Connection pipework of the aquatherm black energy grid to the distribution system

The connection of the heating/cooling circuits from the manifold or the main pipework is routed into the room, e.g. through the floor/wall/ceiling, in accordance with the applicable regulations. The Flexible connection pipe 20 x 3.4 mm can be used for this. We recommend fastening the connecting pipes with black plastic fastening clamps in accordance with our specifications. Common variants of the hydraulic connection of heating and cooling elements are the classic pipework as a zone, similar to the Tichelmann system, and pipework via a manifold.

#### 6. Closing the clamping cassette ceiling (on site)

The closing of the clamping cassettes and the final assembly must be carried out in accordance with the provisions of DIN EN 13964.

Any insulation required in accordance with fire protection or sound insulation requirements should also be installed.

#### Note:

The material for the substructure and the metal ceiling are not included in aquatherm's scope of delivery and must therefore be procured by the customer.

#### Detail: Connection pipework between the grids

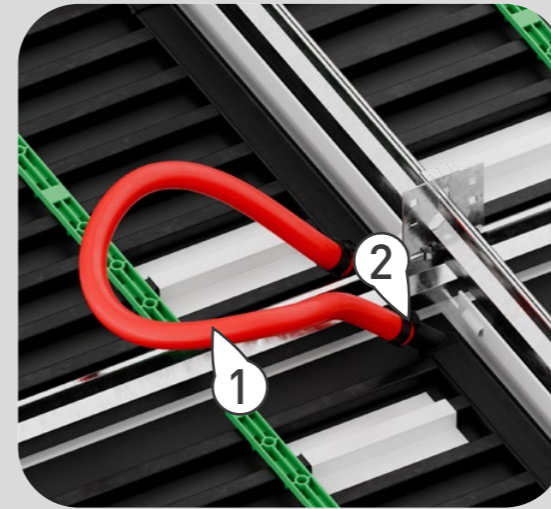

1. Flexible connection pipe (art. no. 4110020001)
2. Spring band clamp (art. no. 9600081074)

#### Detail: Fixing the ceiling grid

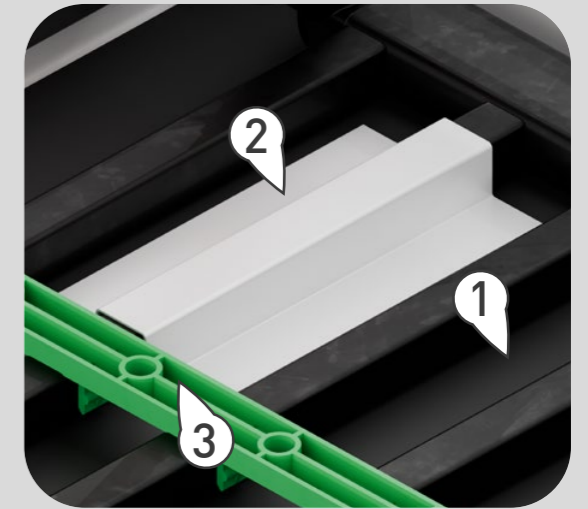

1. Acoustic fleece
2. Heat conduction module (art. no. 9700081284)
3. Fastening element with dowels (art. no. 4050000013)  
Pre-assembled at the factory

#### Section: Fixing the ceiling grid

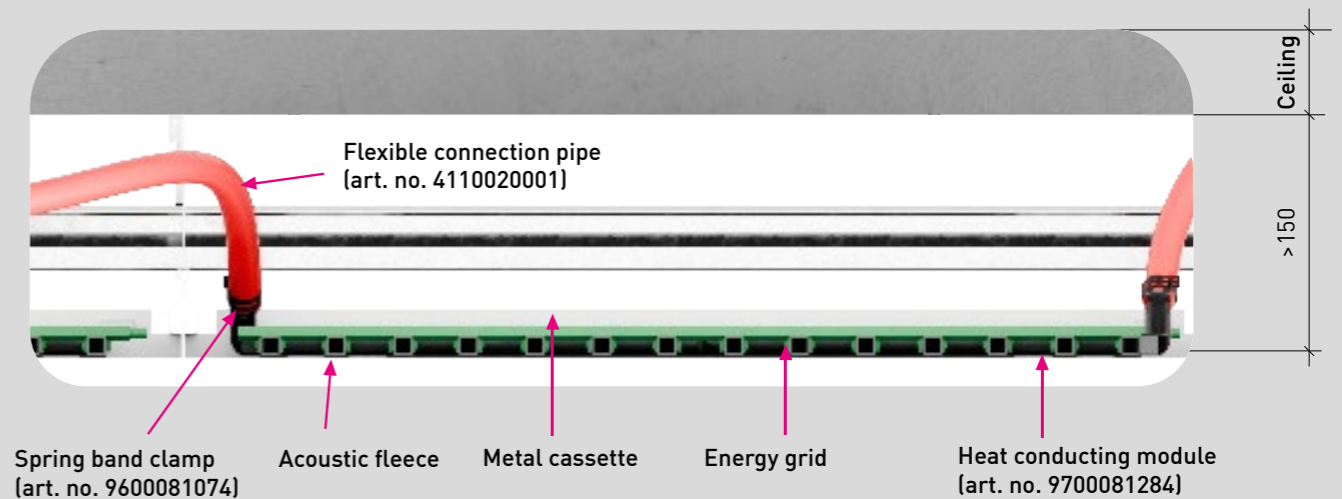



## Ceiling system: Metal cassette as clamping/hanging system

### ASSEMBLY DESCRIPTION

**Grid with push-fit connection  
45° top left, bottom right (mutual)**

CONNECTION TYPE 44

#### 1. Substructure (on site)

The substructure must be installed in accordance with the recognised rules of technology, generally applicable standards and regulations and the manufacturer's instructions. Ensure horizontal and aligned installation. The spacing of the grating clamping profiles must be created (in accordance with DIN 18168 and DIN EN 13964) in accordance with the manufacturer's instructions.

#### 2. Installation of the clamping cassettes (on site)

The clamping cassettes must be installed in accordance with the provisions of DIN EN 13964. It must be ensured that the grids are filled with water (or the corresponding medium) during installation of the clamping cassette ceiling and are under system pressure.

#### 3. Installation of the aquatherm energy grid

To ensure a smooth installation process, the centre height of the metal cassettes should be at least 150 mm. The grids are placed in the clamping cassettes according to the installation plan and fixed in place using heat conducting modules (100 mm aluminium sheet strips). Depending on the requirements, mineral wool insulation (min. 30 mm, shrink-wrapped in PE film) can be placed on the grids.

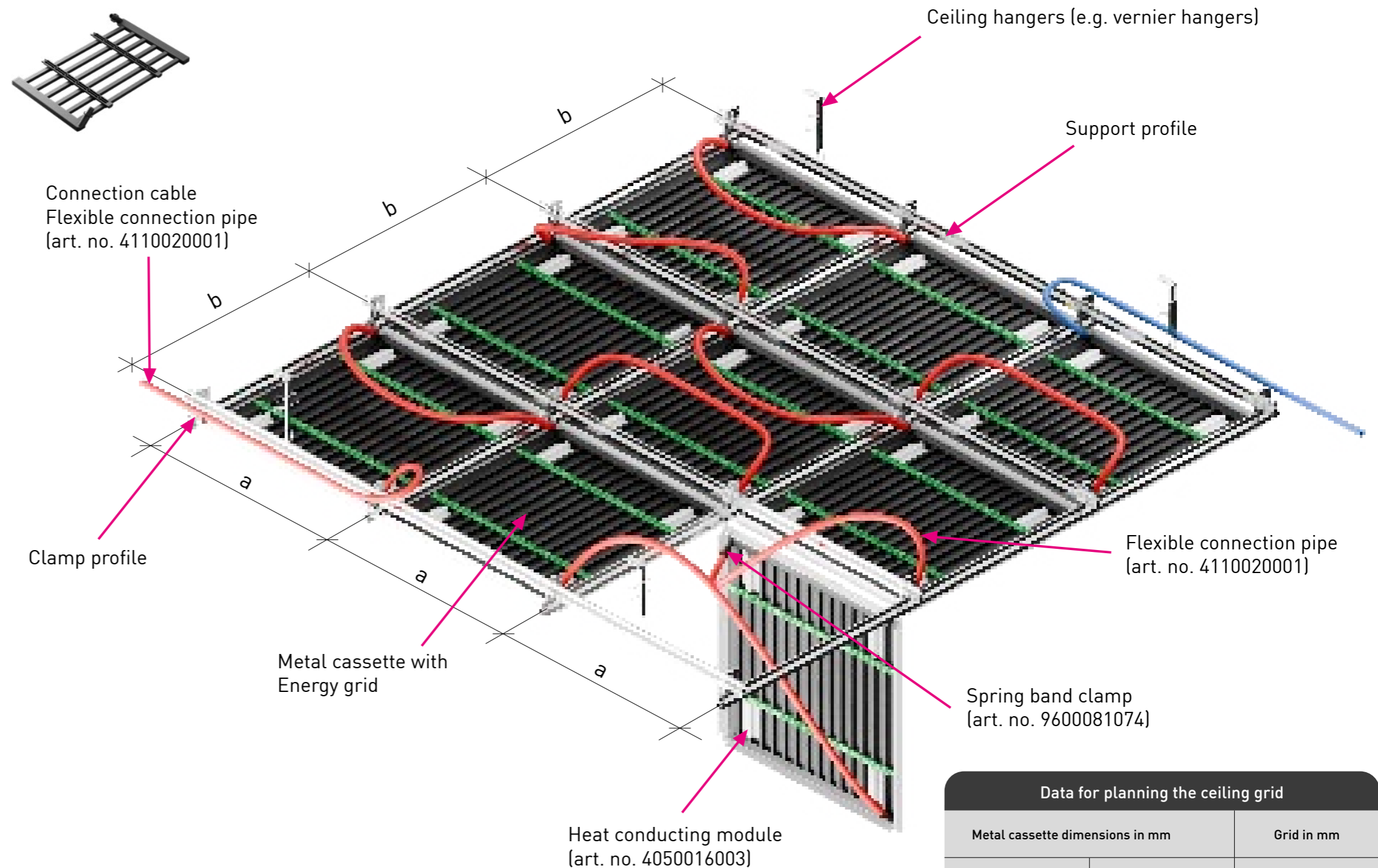

#### Mounting with heat conducting modules

Grid	Heat conducting modules
1m <sup>2</sup>	12

#### Data for planning the ceiling grid

Metal cassette dimensions in mm		Grid in mm
a	b	-
600	600	520 x 580
625	625	560 x 600
Spacing of substructure according to manufacturer's instructions		
Special solutions on request		





## Ceiling system: Metal cassette as clamping/hanging system

### ASSEMBLY DESCRIPTION

**Grid with push-fit connection  
45° top left, bottom right (mutual)**

CONNECTION TYPE 44

#### 4. Connection of the aquatherm energy grids

The grids for installation in the terminal cassettes are supplied with a 45° push-fit connection (top left, bottom right - mutual) with flow interruption. This ensures a uniform flow.  
Once the grids have been installed in the ceiling canopy under the ceiling, they are hydraulically connected to form heating and cooling circuits in accordance with the installation plan. Common variants of the hydraulic connection of heating and cooling elements are the classic pipework as a zone, similar to the Tichelmann system, and pipework via a manifold. The Flexible connection pipe 20 x 3.4 mm with our spring band clamps is used for this (see connection detail). The length of the connecting pipework must be observed - 750 mm on one side and 1500 mm on the other - so that the cassettes can be opened easily in the specified folding direction.

#### 5. Connection pipework of the aquatherm black energy grid to the distribution system

The connection of the heating/cooling circuits from the manifold or the main pipework is routed into the room, e.g. through the floor/wall/ceiling, in accordance with the applicable regulations. The Flexible connection pipe 20 x 3.4 mm can be used for this.

We recommend fastening the connecting pipes with black plastic fastening clamps in accordance with our specifications. Common variants for the hydraulic connection of heating and cooling elements are classic pipework as a zone, similar to the Tichelmann system, and pipework via a manifold.

#### 6. Closing the clamping cassette ceiling (on site)

The closing of the clamping cassettes and the final assembly must be carried out in accordance with the provisions of DIN EN 13964. Any insulation required in accordance with fire protection or sound insulation requirements should also be installed.

#### Note:

The material for the substructure and the metal ceiling are not included in aquatherm's scope of delivery and must therefore be procured by the customer.

#### Detail: Connection pipework between the grids

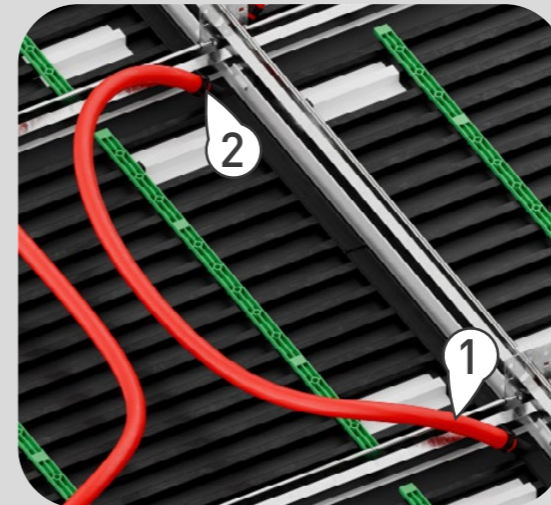

- 1. Flexible connection pipe (art. no. 4110020001)
- 2. Spring band clamp (art. no. 9600081074)

#### Detail: Fixing the ceiling grid

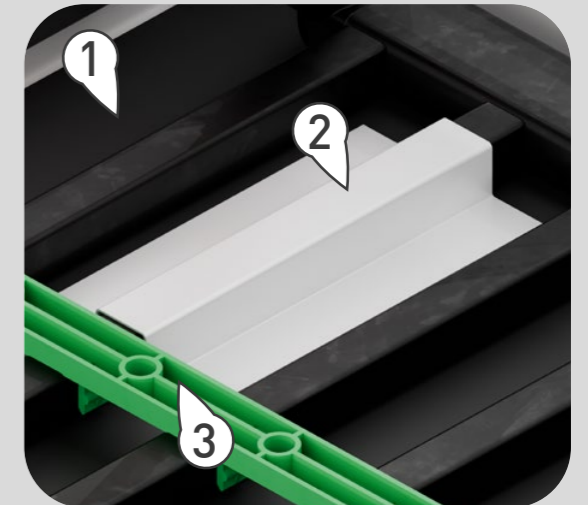

- 1. Acoustic fleece
- 2. Heat conduction module (art. no. 9700081284)
- 3. Fastening element with dowels (art. no. 4050000013)  
Pre-assembled at the factory

#### Section: Fixing the ceiling grid

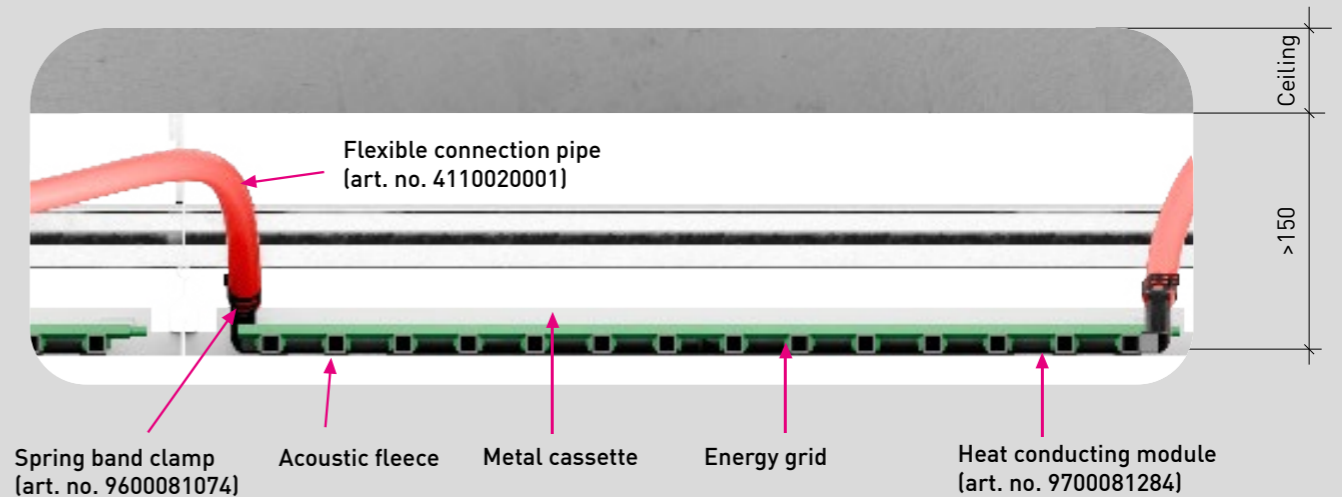

- Spring band clamp (art. no. 9600081074)
- Acoustic fleece
- Metal cassette
- Energy grid
- Heat conducting module (art. no. 9700081284)



## Ceiling system: Metal cassette with strip grid \_\_

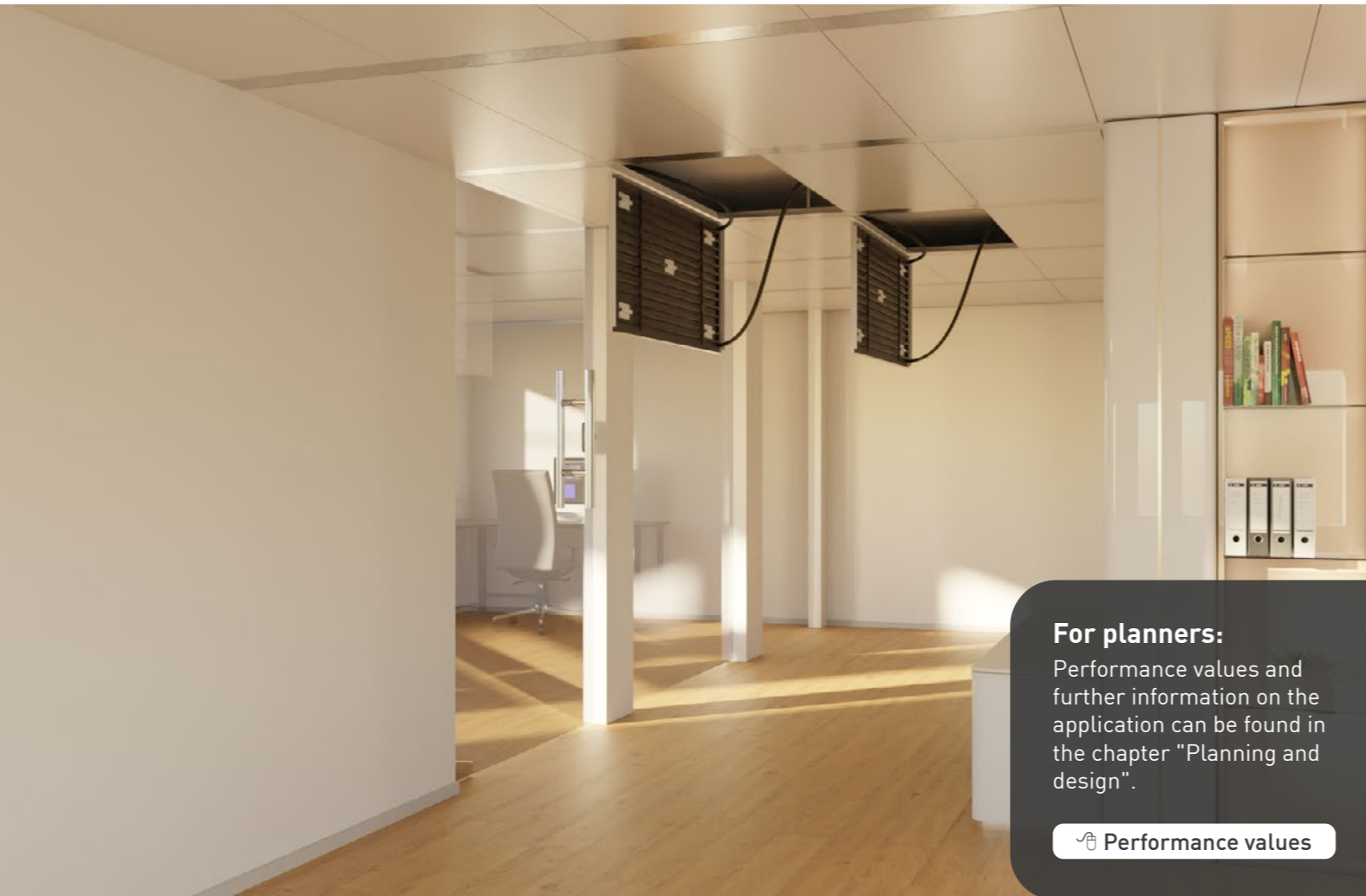

### For planners:

Performance values and further information on the application can be found in the chapter "Planning and design".

 Performance values

### Advantages:

- High heating and cooling performance due to excellent contact transfer surface.
- Factory prefabricated grid modules for quick installation on site.
- Quick and easy installation thanks to fixing via heat conducting modules.
- Increased performance through heat conducting modules.
- Combination with centrally treated outside air possible.
- System can be retrofitted into existing metal ceiling systems.
- High sound absorption with metal ceiling tiles with micro-perforation.
- Silent and invisible heating and cooling function.
- Installation in combination with various ceiling installations/structures such as lights, fire alarms and ventilation components.
- Clear separation of the two trades: Building technology and ceiling construction.

Ceiling



### System description

The aquatherm black energy grids for heating and cooling are inserted into the metal clamping cassettes and fixed in place using heat conducting modules. Direct contact between the grids and the sheet metal or acoustic fleece ensures good power transfer.

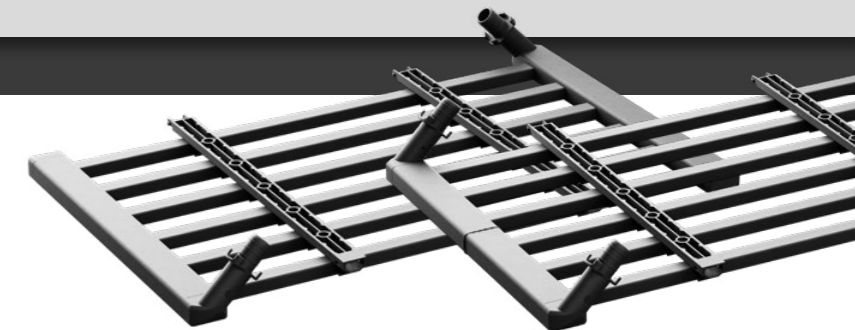





## Ceiling system: Metal cassette with strip grid

### ASSEMBLY DESCRIPTION

**Grid with push-fit connection  
45° left, right (one-sided)**

CONNECTION TYPE 43



### 1. Substructure (on site)

The substructure must be installed in accordance with the recognised rules of technology, generally applicable standards and regulations and the manufacturer's instructions.

Ensure that the installation is horizontal and flush. The spacing of the grating clamping profiles must be created (in accordance with DIN 18168 and DIN EN 13964) according to the manufacturer's instructions.

### 2. Mounting the tape grid cassettes

The installation of the strip grid cassettes must be carried out in accordance with the provisions of DIN EN 13964. It must be ensured that the grids are filled with water (or the corresponding medium) and are under system pressure during the installation of the strip grid cassette ceiling.

### 3. Installation of the aquatherm energy grid

To ensure a smooth installation process, the centre height of the metal cassettes should be at least 150 mm. The grids are placed in the strip grid cassette according to the installation plan and fixed in place using heat conducting modules (100 mm aluminium sheet strips). Depending on requirements, mineral wool insulation (min. 30 mm, shrink-wrapped in PE film) can be placed on the grids.

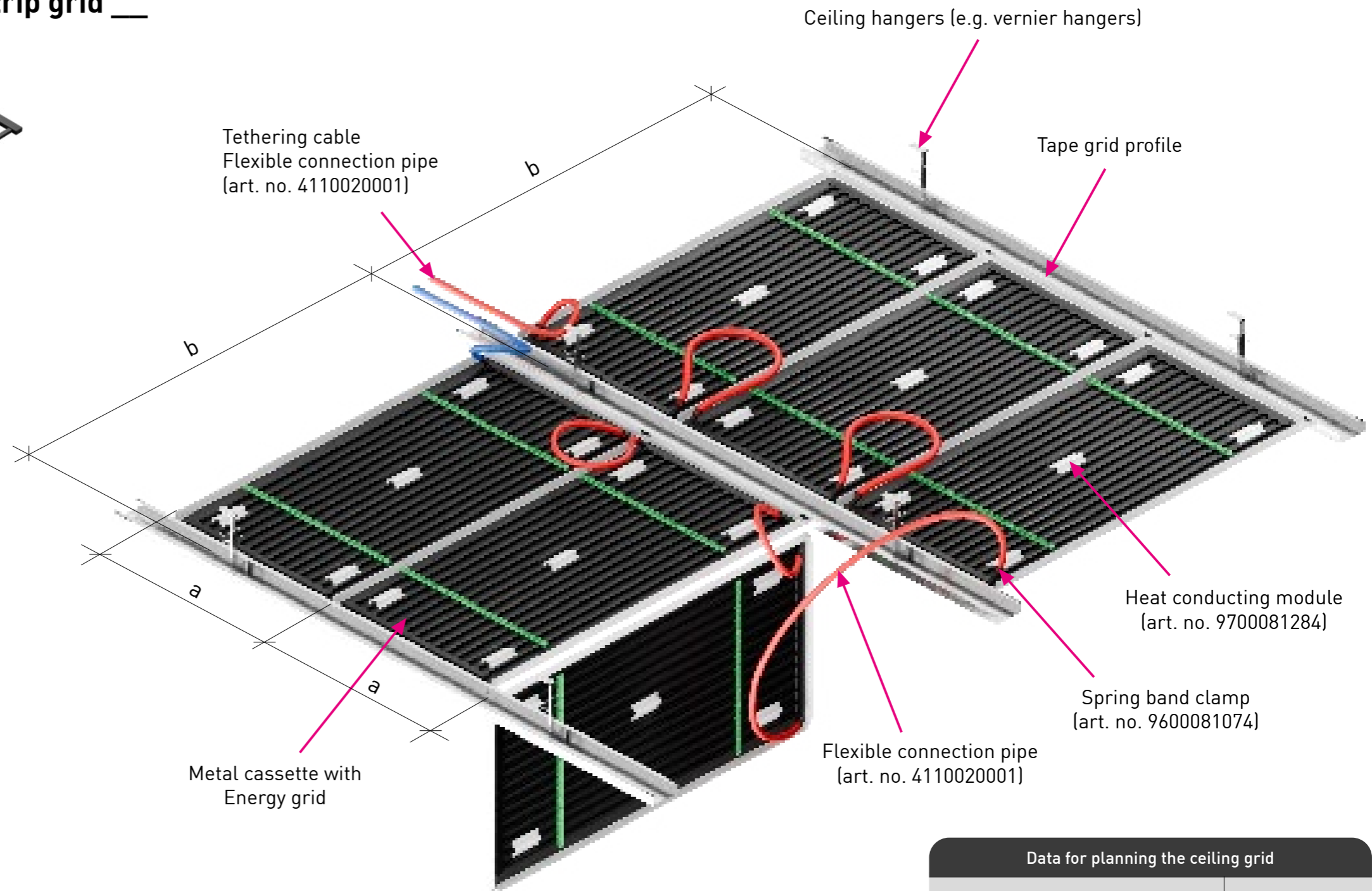

### Mounting with heat conducting modules

Grid	Heat conducting modules
1m <sup>2</sup>	12

### Data for planning the ceiling grid

Metal cassette dimensions in mm		Grid in mm
a	b	-
600	1200	560 x 1180
625	1250	560 x 1200

Spacing of substructure according to manufacturer's instructions

Special solutions on request



## Ceiling system: Metal cassette with strip grid \_\_\_

### ASSEMBLY DESCRIPTION

#### Grid with push-fit connection 45° left, right (one-sided)

CONNECTION TYPE 43

#### 4. Connection of the aquatherm energy grids

The grids for installation in the band grid cassettes are supplied with a 45° push-fit connection (left, right - one-sided) with flow interruption. This ensures a uniform flow.

Once the grids have been installed in the ceiling canopy on the ceiling, they are hydraulically connected to form heating and cooling zones in accordance with the installation plan. Common variants of the hydraulic connection of heating and cooling elements are classic pipework as a zone, as a Tichelmann system and pipework via a manifold.

The Flexible connection pipe 20 x 3.4 mm with our spring band clamps is used for this (see connection detail). Please note the length of the connecting pipework - 750 mm on one side and 1500 mm on the other - so that the cassettes can be opened easily in the specified folding direction.

#### 5. Connection pipework of the aquatherm black energy grid to the distribution system

The connection of the heating/cooling circuits from the manifold or the main pipework is routed into the room, e.g. through the floor/wall/ceiling, in accordance with the applicable regulations. The Flexible connection pipe 20 x 3.4 mm can be used for this. We recommend fastening the connecting pipes with black plastic fastening clamps in accordance with our specifications. Common variants of the hydraulic connection of heating and cooling elements are classic pipework as a zone, as a Tichelmann system and pipework via a manifold.

#### Detail: Connection cross tape grid

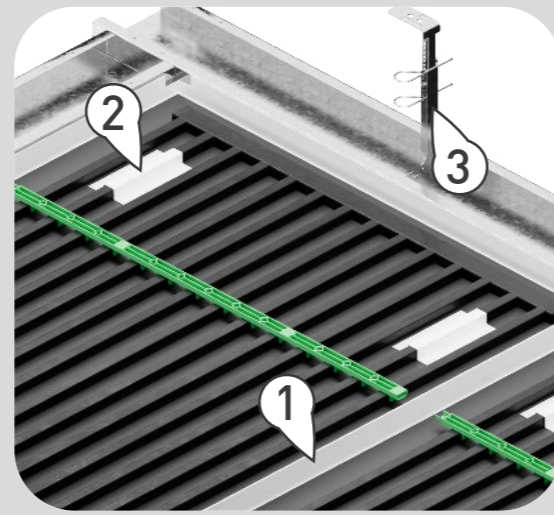

1. Tape grid profile
2. Heat conduction module (Art-Nr. 9700081284)
3. Ceiling hanger (e.g. vernier hanger)

#### Detail: Connection cross tape grid

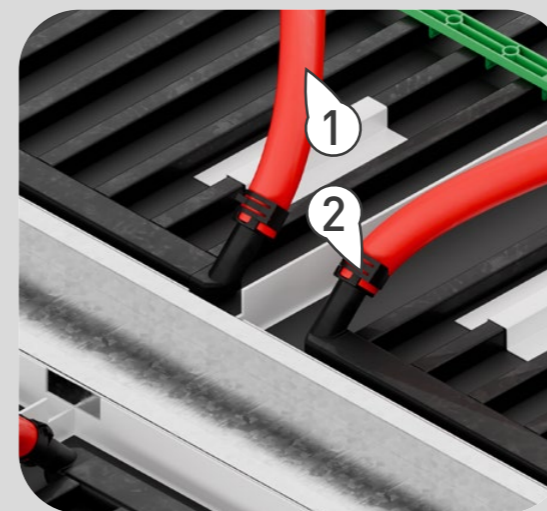

1. Flexible connection pipe (art. no. 4110020001)  
Minimum length min. 750 mm
2. Spring band clamp (art. no. 9600081074)

#### Detail: Connection cross tape grid

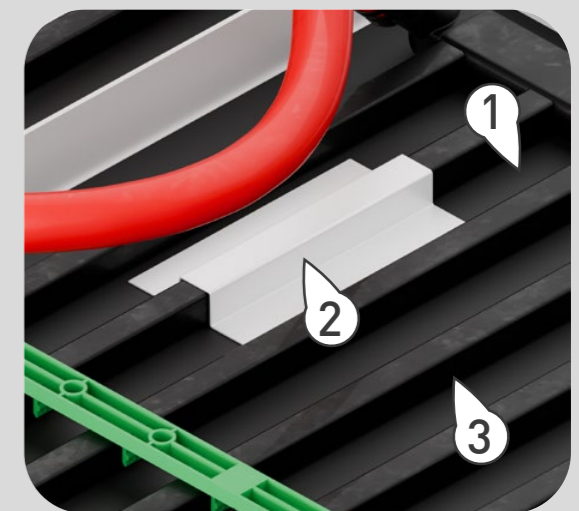

1. Acoustic fleece
2. Heat conduction module (art. no. 9700081284)
3. Energy grid





## Ceiling system: Metal cassette with strip grid \_\_\_

### Section: Fixing the ceiling grid

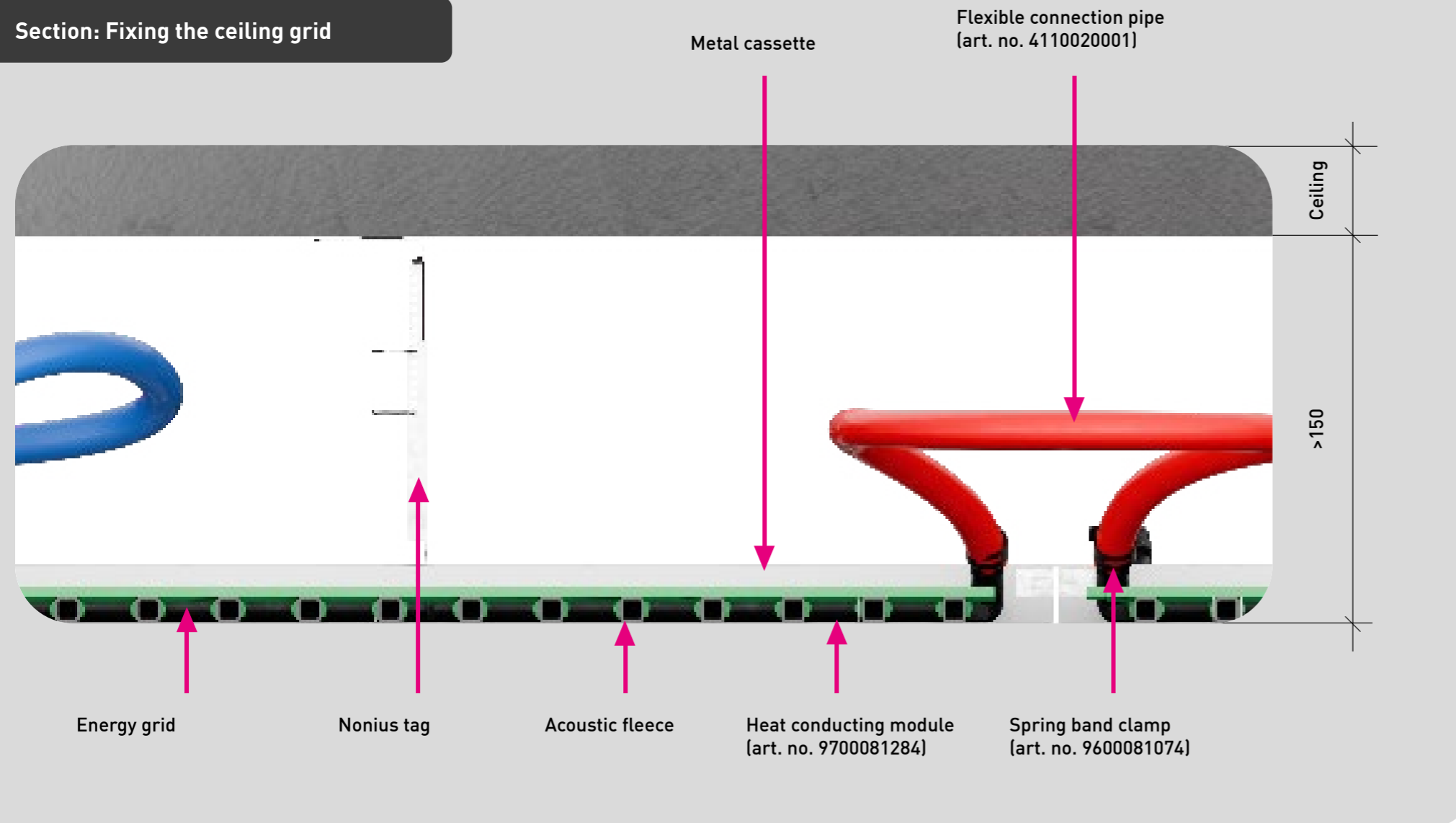

### 6. Closing the ribbon grid cassette ceiling

The sealing of the strip grid cassettes and the final assembly must be carried out in accordance with the provisions of DIN EN 13964. Any insulation required in accordance with fire protection or sound insulation requirements should also be installed.

#### Note:

The material for the substructure and the metal ceiling are not included in aquatherm's scope of delivery and must therefore be procured by the customer.



## Ceiling system: Metal cassette with strip grid

### ASSEMBLY DESCRIPTION

**Grid with push-fit connection  
45° top left, bottom right (mutual)**

CONNECTION TYPE 44

#### 1. Substructure (on site)

The substructure must be installed in accordance with the recognised rules of technology, generally applicable standards and regulations and the manufacturer's instructions. Ensure horizontal and aligned installation. The spacing of the grating clamping profiles must be created (in accordance with DIN 18168 and DIN EN 13964) in accordance with the manufacturer's instructions.

#### 2. Mounting the tape grid cassettes

The installation of the strip grid cassettes must be carried out in accordance with the provisions of DIN EN 13964. It must be ensured that the grids are filled with water (or the corresponding medium) and are under system pressure during the installation of the strip grid cassette ceiling.

#### 3. Installation of the aquatherm energy grid

To ensure a smooth installation process, the centre height of the metal cassettes should be at least 150 mm. The grids are placed in the strip grid cassette according to the installation plan and fixed in place using heat conducting modules (100 mm aluminium sheet strips). Depending on requirements, mineral wool insulation (min. 30 mm, shrink-wrapped in PE film) can be placed on the grids.

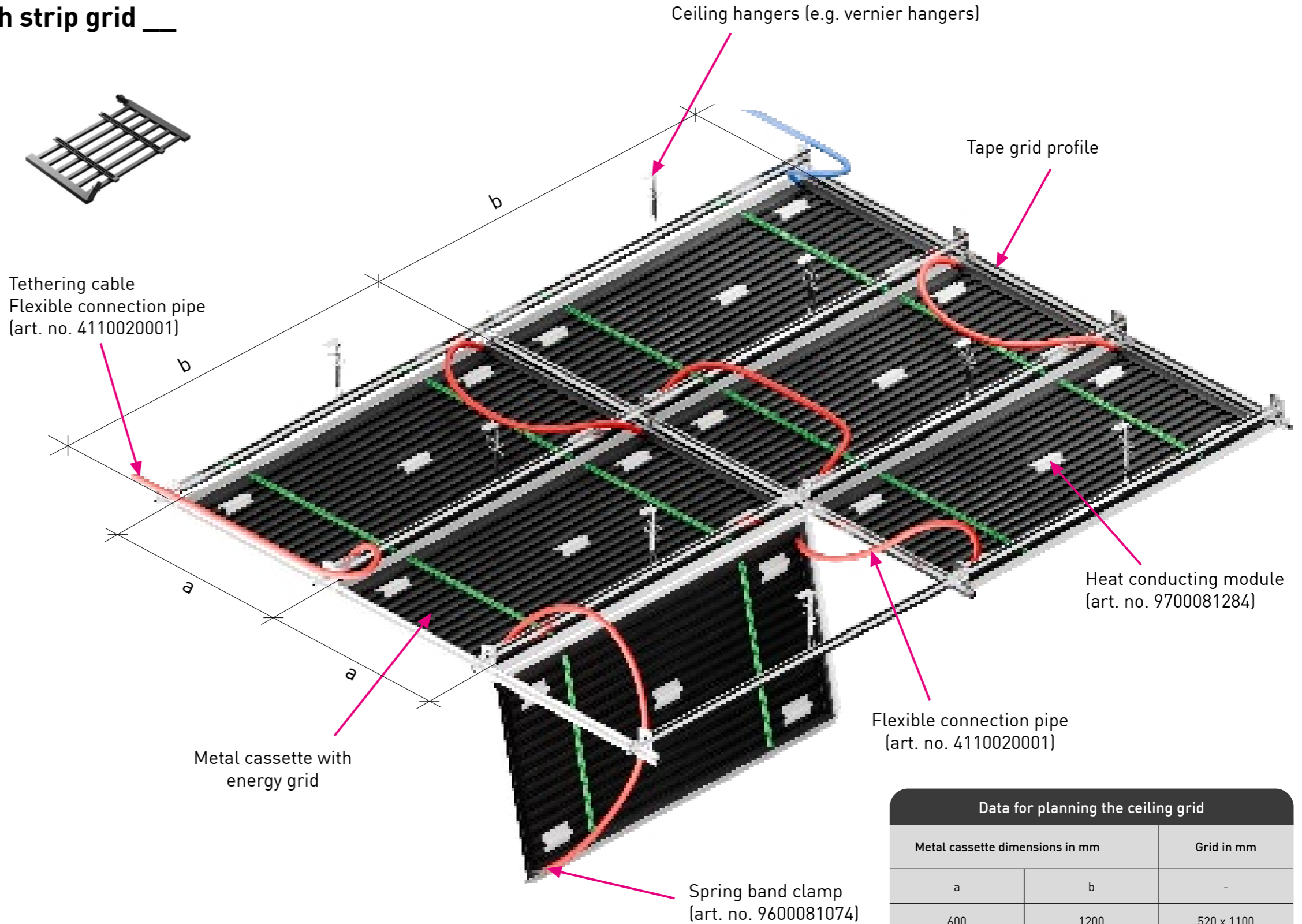

#### Mounting with heat conducting modules

Grid	Heat conducting modules
1m <sup>2</sup>	12

#### Data for planning the ceiling grid

Metal cassette dimensions in mm		Grid in mm
a	b	-
600	1200	520 x 1100
625	1250	560 x 1180
Spacing of substructure according to manufacturer's instructions		
Special solutions on request		





## Ceiling system: Metal cassette with strip grid \_\_

### ASSEMBLY DESCRIPTION

#### Grid with push-fit connection 45° top left, bottom right (mutual)

CONNECTION TYPE 44

#### 4. Connection of the aquatherm energy grids

The grids for installation in the band grid cassettes are supplied with a **45° top left, bottom right (mutual) push-fit connection** with flow interruption. This ensures a uniform flow.

Once the grids have been installed in the ceiling canopy on the ceiling, they are hydraulically connected to form heating and cooling zones in accordance with the installation plan. Common variants of the hydraulic connection of heating and cooling elements are classic pipework as a zone, as a Tichelmann system and pipework via a manifold. The Flexible connection pipe 20 x 3.4 mm with our spring band clamps is used for this (see Connection detail). Please note the length of the connecting pipework - 750 mm on one side and 1500 mm on the other - so that the cassettes can be opened easily in the specified folding direction.

#### 5. Connection pipework of the aquatherm black energy grid to the distribution system

The connection of the heating/cooling circuits from the manifold or the main pipework is routed into the room, e.g. through the floor/wall/ceiling, in accordance with the applicable regulations. The Flexible connection pipe 20 x 3.4 mm can be used for this purpose. We recommend fastening the connecting pipes with black plastic fastening clamps in accordance with our specifications. Common variants of the hydraulic connection of heating and cooling elements are classic pipework as a zone, as a Tichelmann system and pipework via a manifold.

#### Detail: Connection cross tape grid

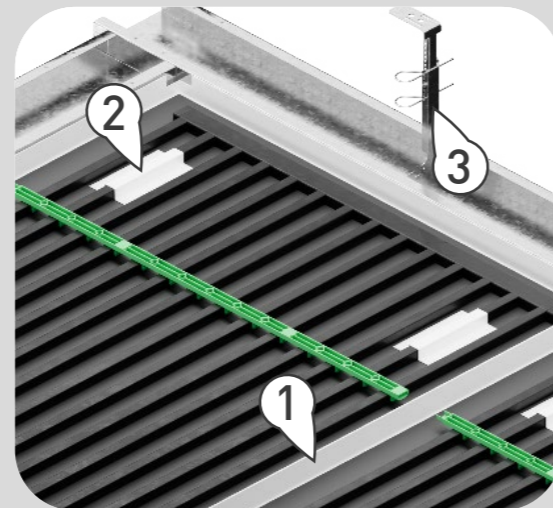

1. Tape grid profile
2. Heat conduction module (Art-Nr. 9700081284)
3. Ceiling hanger (e.g. vernier hanger)

#### Detail: Connection pipework between the grids

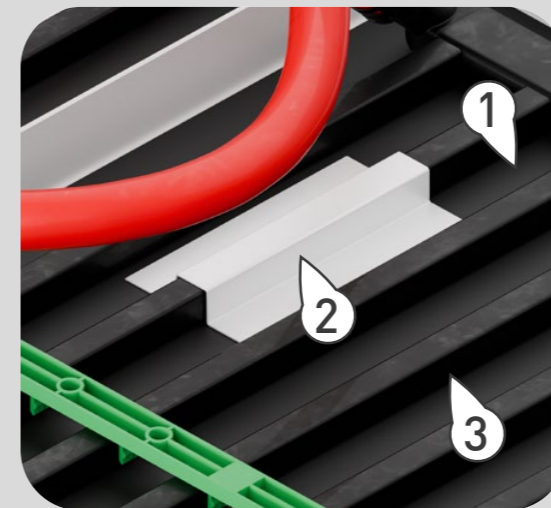

1. Acoustic fleece
2. Heat conduction module (art. no. 9700081284)
3. Energy grid

#### Detail: Grid fastening in metal cassettes

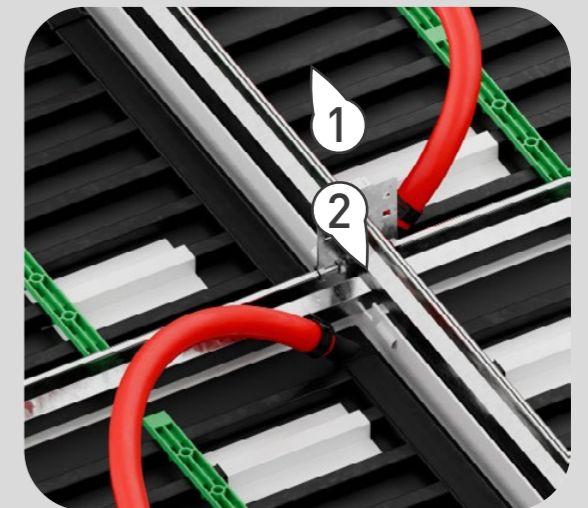

1. Flexible connection pipe (art. no. 4110020001) min. 750 mm
2. Spring band clamp (art. no. 9600081074)



## Ceiling system: Metal cassette with strip grid \_\_\_

### Section: Fixing the ceiling grid

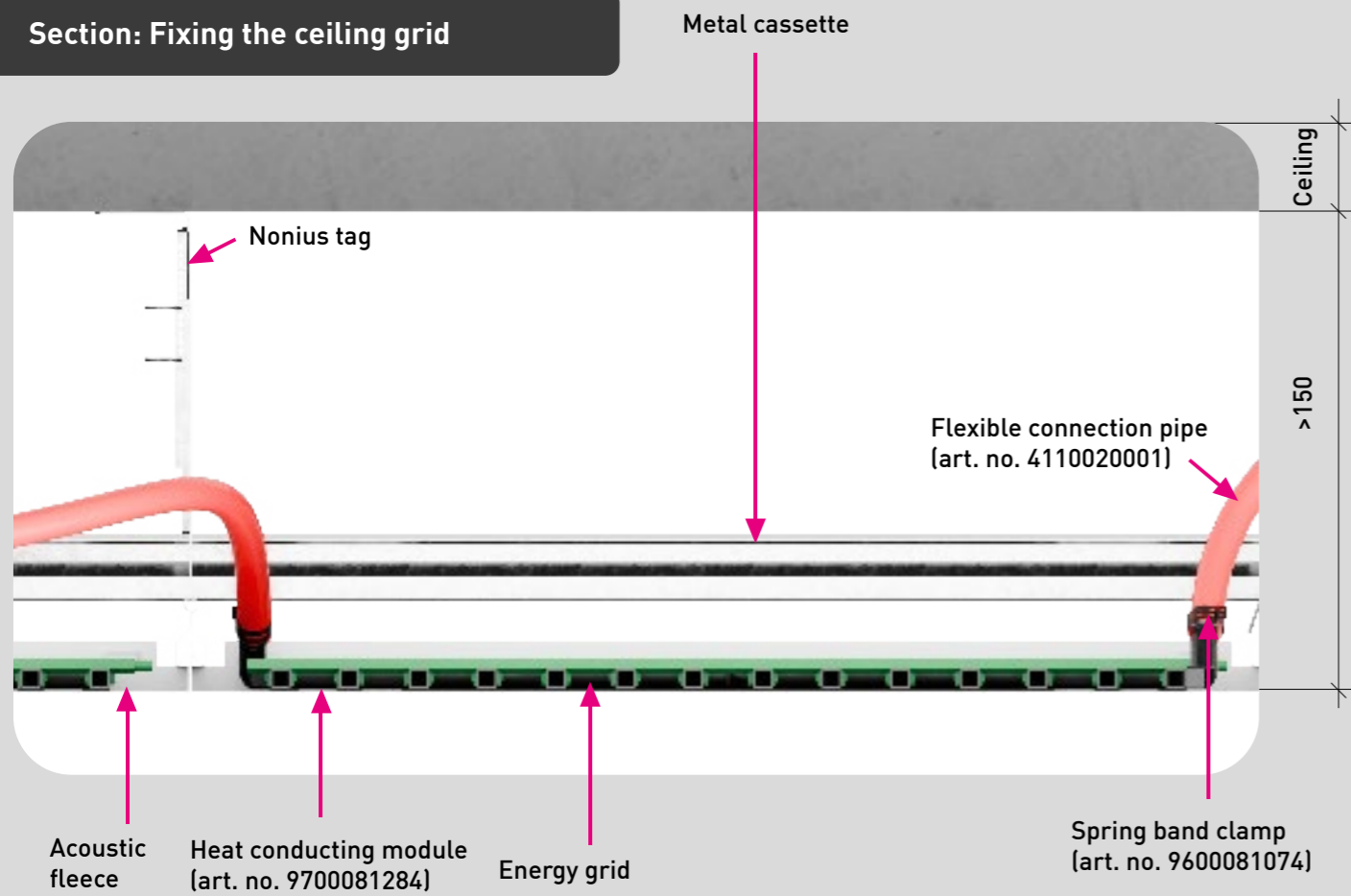

### 6. Closing the ribbon grid cassette ceiling

The sealing of the strip grid cassettes and the final assembly must be carried out in accordance with the provisions of DIN EN 13964. Any insulation required in accordance with fire protection or sound insulation requirements should also be installed.

#### Note:

The material for the substructure and the metal ceiling are not included in aquatherm's scope of delivery and must therefore be procured by the customer.





## Ceiling system: Metal cassette with expanded metal\_\_



### Advantages:

- High heating and cooling performance due to excellent contact transfer surface.
- Factory prefabricated grid modules for quick installation on site.
- Quick and easy installation thanks to fixing via heat conducting modules.
- Increased performance thanks to heat conducting modules. With over 80% large meshes, Performance increase of the expanded metal ceiling.
- Combination with centrally treated outside air possible.
- System can be retrofitted into existing metal ceiling systems.
- High sound absorption with metal ceiling tiles with micro-perforation.
- Silent and invisible heating and cooling function.
- Installation in combination with various ceiling installations/structures such as lights, fire alarms and ventilation components.
- Clear separation of the two trades: building technology and ceiling construction.



### System description

The aquatherm black energy grids for heating and cooling are inserted into the expanded metal cassettes and secured with heat conducting modules. Direct contact between the grids and the expanded metal or acoustic fleece ensures good power transfer.





## Ceiling system: Metal cassette with expanded metal\_\_

### ASSEMBLY DESCRIPTION

**Grid with push-fit connection  
45° left, right (one-sided)**

CONNECTION TYPE 43



#### 1. Substructure (on site)

The substructure must be installed in accordance with the recognised rules of technology, generally applicable standards and regulations and the manufacturer's instructions.

Ensure that the installation is horizontal and flush. The spacing of the grating clamping profiles must be created (in accordance with DIN 18168 and DIN EN 13964) according to the manufacturer's instructions.

#### 2. Assembly of the expanded metal cassette

The expanded metal system must be installed in accordance with the provisions of DIN EN 13964. It must be ensured that the grids are filled with water (or the corresponding medium) during the installation of the expanded metal ceiling and are under system pressure.

#### 3. Installation of the aquatherm energy grid

To ensure a smooth installation process, the centre height of the expanded metal cassettes should be at least 150 mm. The grids are placed in the cassettes according to the installation plan and fixed in place using heat conducting modules (100 mm aluminium sheet strips). Depending on the requirements, mineral wool insulation (min. 30 mm, shrink-wrapped in PE foil) can be placed on the grids.

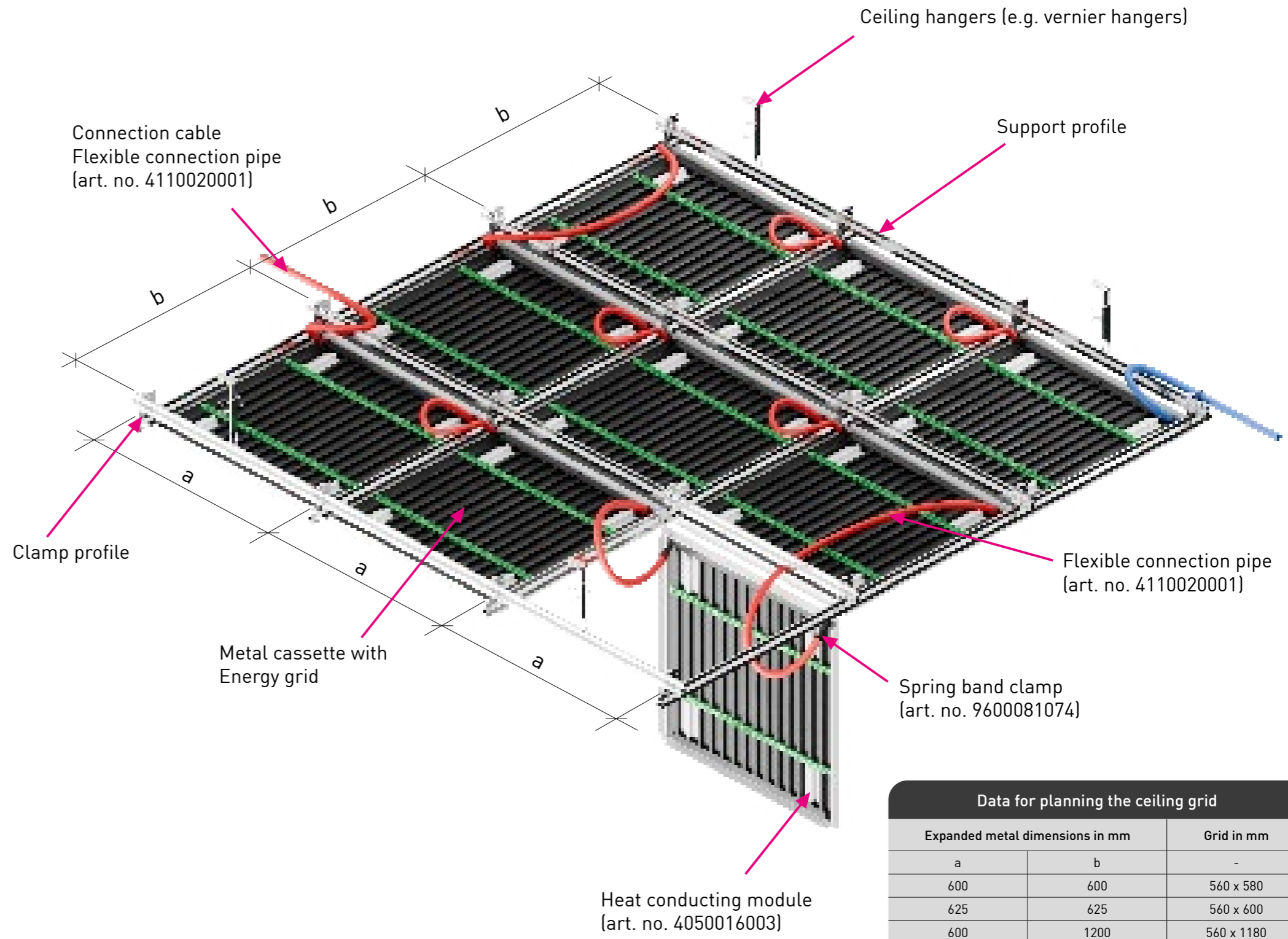

#### Mounting with heat conducting modules

Grid	Heat conducting modules
1m <sup>2</sup>	12

#### Data for planning the ceiling grid

Expanded metal dimensions in mm		Grid in mm
a	b	-
600	600	560 x 580
625	625	560 x 600
600	1200	560 x 1180
625	1250	560 x 1200

Spacing of substructure according to manufacturer's instructions

Special solutions on request





## Ceiling system: Metal cassette with expanded metal\_\_\_

### ASSEMBLY DESCRIPTION

#### Grid with push-fit connection 45° left, right (one-sided)

CONNECTION TYPE 43

#### 4. Connection of the aquatherm energy grids

The grids for installation in the expanded metal cassettes are supplied with a **45° push-fit connection (left, right - one-sided)** with flow interruption. This ensures a uniform flow. Once the grids have been installed in the ceiling canopy on the ceiling, they are hydraulically connected to form heating or cooling zones in accordance with the installation plan. Common variants of the hydraulic connection of heating and cooling elements are classic pipework as a zone, as a Tichelmann system and pipework via a manifold. The Flexible connection pipe 20 x 3.4 mm with our spring band clamps is used for this (see connection detail). Please note the length of the connecting pipework - 750 mm on one side and 1500 mm on the other - so that the cassettes can be opened easily in the specified folding direction.

#### 5. Connection pipework of the aquatherm black energy grid to the distribution system

The connection of the heating/cooling circuits from the manifold or the main pipework is routed into the room, e.g. through the floor/wall/ceiling, in accordance with the applicable regulations. The Flexible connection pipe 20 x 3.4 mm can be used for this. We recommend fastening the connecting pipes with black plastic fastening clamps in accordance with our specifications. Common variants of the hydraulic connection of heating and cooling elements are classic pipework as a zone, as a Tichelmann system and pipework via a manifold.

#### 6. Closing the expanded metal ceiling

The sealing of the expanded metal ceiling and the final assembly must be carried out in accordance with the provisions of DIN EN 13964. Any insulation required in accordance with fire protection or sound insulation requirements should also be installed.

#### Note:

The material for the substructure and the metal ceiling are not included in aquatherm's scope of delivery and must therefore be procured by the customer.

#### Detail: Fixing the ceiling grid

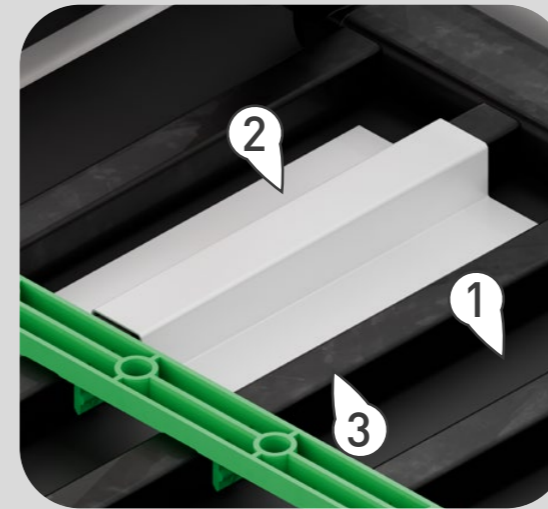

1. Acoustic fleece
2. Heat conduction module (art. no. 9700081284)
3. Energy grid

#### Detail: Connection pipework between the grids

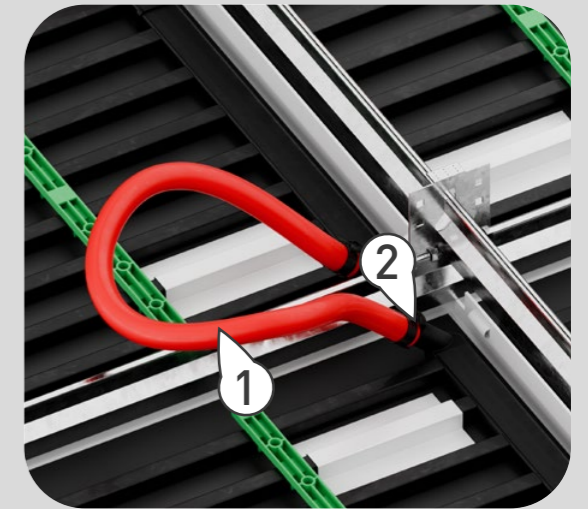

1. Flexible connection pipe (art. no. 4110020001)
2. Spring band clamp (art. no. 9600081074)

#### Section: Fixing the ceiling grid

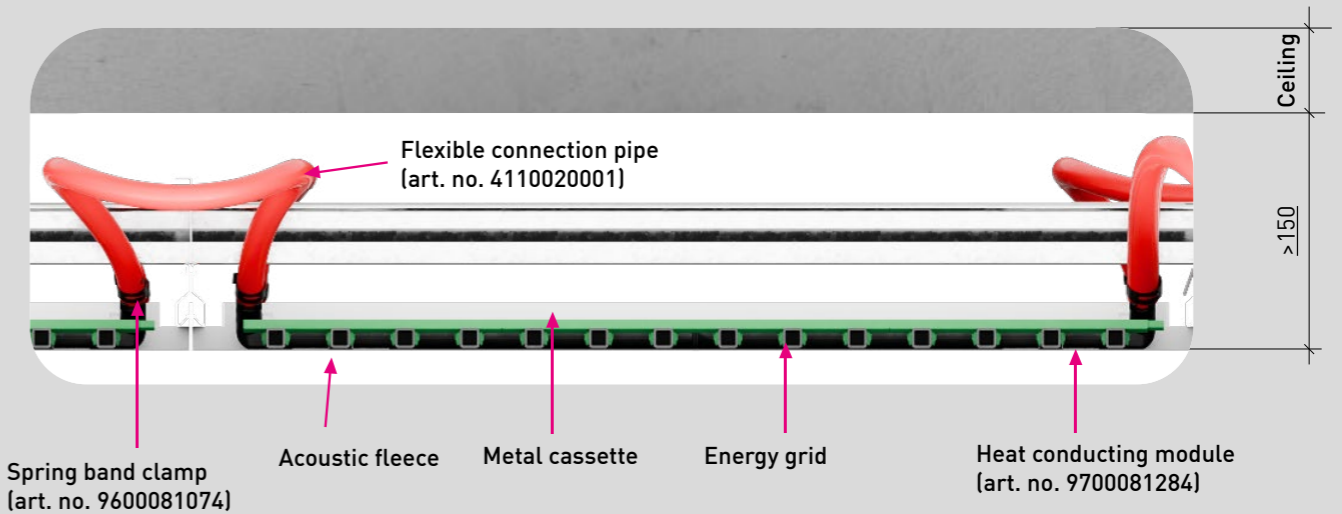



## Ceiling system: Metal cassette with expanded metal\_\_

### ASSEMBLY DESCRIPTION

**Grid with push-fit connection  
45° top left, bottom right (mutual)**

CONNECTION TYPE 44

#### 1. Substructure (on site)

The substructure must be installed in accordance with the recognised rules of technology, generally applicable standards and regulations and the manufacturer's instructions.

Ensure that the installation is horizontal and flush. The spacing of the grating clamping profiles must be created (in accordance with DIN 18168 and DIN EN 13964) according to the manufacturer's instructions.

#### 2. Assembly of the expanded metal cassette

The expanded metal system must be installed in accordance with the provisions of DIN EN 13964. It must be ensured that the grids are filled with water (or the corresponding medium) during the installation of the expanded metal ceiling and are under system pressure.

#### 3. Installation of the aquatherm energy grid

To ensure a smooth installation process, the centre height of the expanded metal cassettes should be at least 150 mm. The grids are placed in the cassettes according to the installation plan and fixed in place using heat conducting modules (100 mm aluminium sheet strips). Depending on the requirements, mineral wool insulation (min. 30 mm, shrink-wrapped in PE foil) can be placed on the grids.

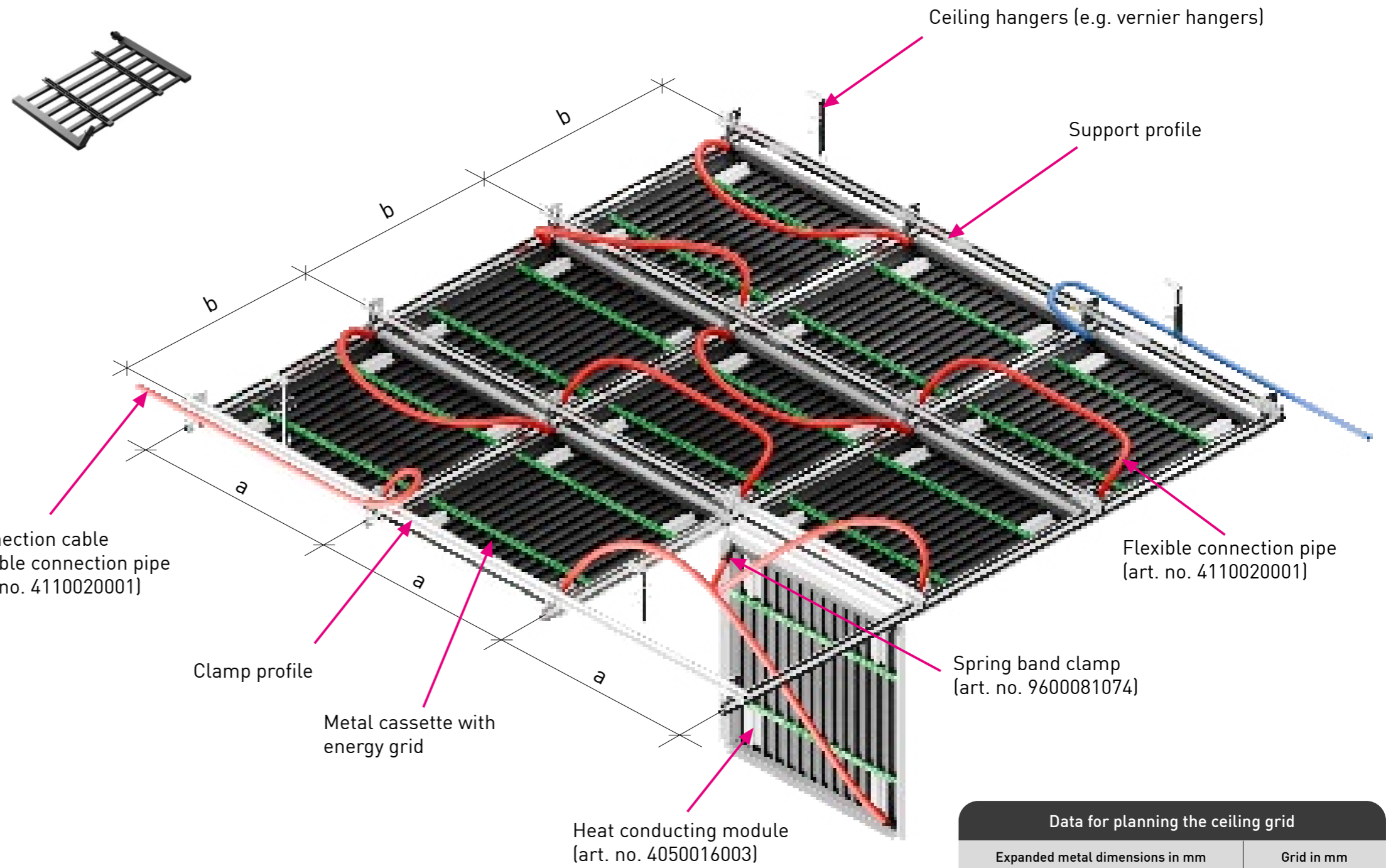

#### Mounting with heat conducting modules

Grid	Heat conducting modules
1m <sup>2</sup>	12

#### Data for planning the ceiling grid

Expanded metal dimensions in mm		Grid in mm
a	b	-
600	600	560 x 580
625	625	560 x 600
600	1200	560 x 1180
625	1250	560 x 1200

Spacing of substructure according to manufacturer's instructions

**Special solutions on request**





## Ceiling system: Metal cassette with expanded metal\_\_

### ASSEMBLY DESCRIPTION

**Grid with push-fit connection  
45° top left, bottom right (mutual)**

CONNECTION TYPE 44

#### 4. Connection of the aquatherm energy grids

The grids for installation in the expanded metal cassettes are supplied with a push-fit connection 45° top left, bottom right (mutual) with flow interruption. This ensures a uniform flow. Once the grids have been installed in the ceiling canopy on the ceiling, they are hydraulically connected to form heating and cooling zones in accordance with the installation plan. Common variants of the hydraulic connection of heating and cooling elements are classic pipework as a zone, as a Tichelmann system and pipework via a manifold. The Flexible connection pipe 20 x 3.4 mm with our spring band clamps is used for this (see Connection detail). Please note the length of the connecting pipework - 750 mm on one side and 1500 mm on the other - so that the cassettes can be opened easily in the specified folding direction.

#### 5. Connection pipework of the aquatherm black energy grid to the distribution system

The connection of the heating/cooling circuits from the manifold or the main pipework is routed into the room, e.g. through the floor/wall/ceiling, in accordance with the applicable regulations. The Flexible connection pipe 20 x 3.4 mm can be used for this. We recommend fastening the connecting pipes with black plastic fastening clamps in accordance with our specifications. Common variants of the hydraulic connection of heating and cooling elements are classic pipework as a zone, as a Tichelmann system and pipework via a manifold.

#### 6. Closing the expanded metal ceiling

The sealing of the expanded metal ceiling and the final assembly must be carried out in accordance with the provisions of DIN EN 13964. Any insulation required in accordance with fire protection or sound insulation requirements should also be installed.

#### Notes:

The material for the substructure and the metal ceiling system must be provided by the customer.

#### Detail: Fixing the ceiling grid

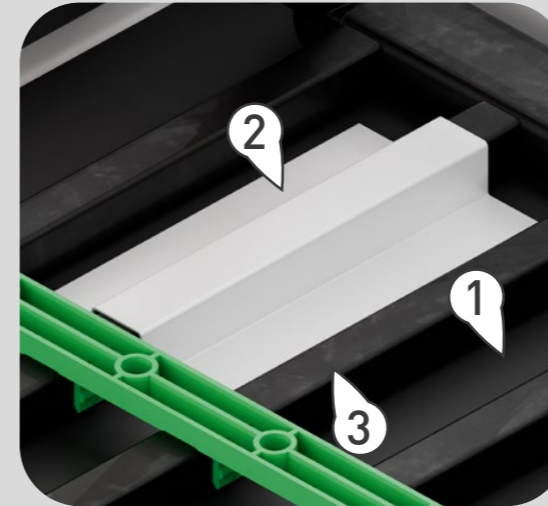

1. Acoustic fleece
2. Heat conduction module (art. no. 9700081284)
3. Energy grid

#### Detail: Connection pipework between the grids

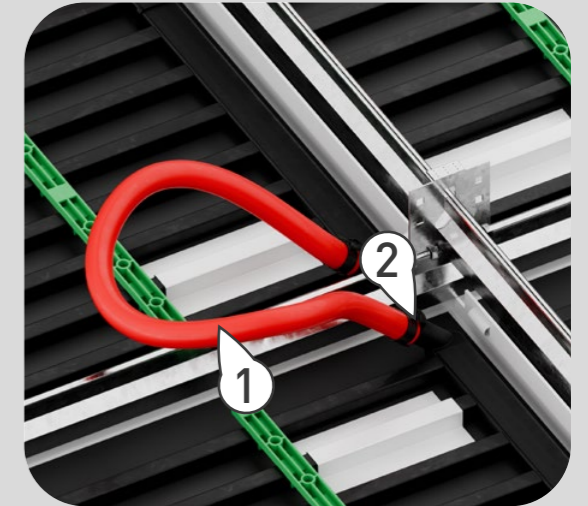

1. Flexible connection pipe (art. no. 4110020001)
2. Spring band clamp (art. no. 9600081074)

#### Section: Fixing the ceiling grid

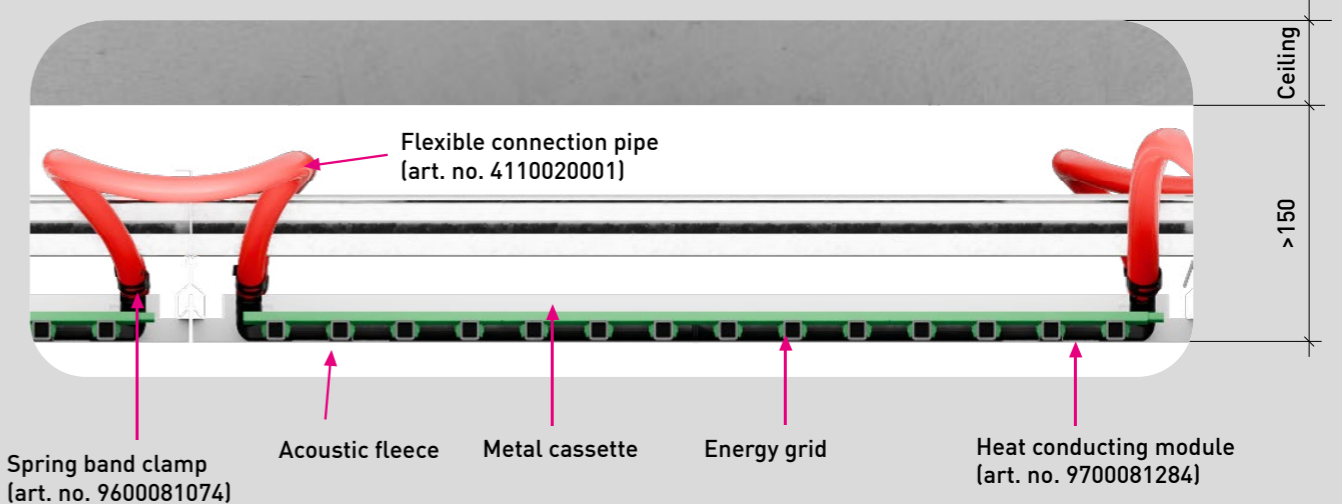



## Ceiling system: Free convection - suspended \_\_\_

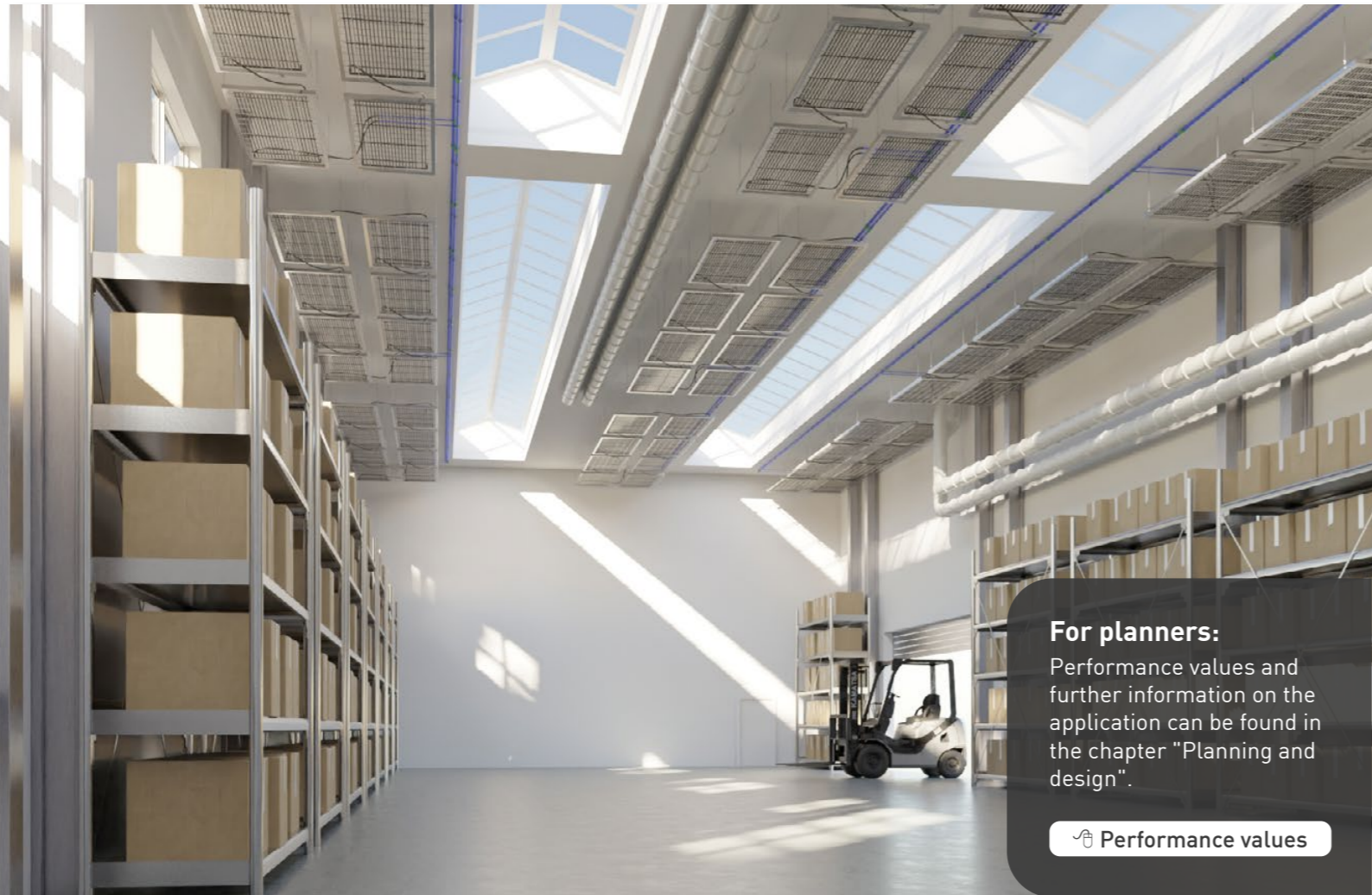

### For planners:

Performance values and further information on the application can be found in the chapter "Planning and design".

[Performance values](#)

### Advantages:

- Very high heating and cooling performance thanks to free convection.
- For expanded metal elements, free convection from approx. 70% large cross-section of the meshes.
- The system can be used variably.
- Combination with other ceiling substructures such as lighting, fire detectors, sprinklers and ventilation components.
- Flexible thanks to the combination of thermally active and passive ceiling elements.
- Attractive design and architectural freedom with the mesh types, shapes and sizes.

Ceiling



### System description

With free convection, the aquatherm black grids lie on a permeable substructure that allows air to circulate freely. The customised aquatherm black grids are placed on the substructure and fixed in place if necessary. The system is characterised by a high level of performance. It is used, for example, for heating individual workstations in industry.





## Ceiling system: Free convection - suspended      Plug-in terminals

### ASSEMBLY DESCRIPTION

**Grid with push-fit connection  
45° left, right (one-sided)**

CONNECTION TYPE 43

#### 1. Suspension sail

The ceiling sails are connected to the bare ceiling by ceiling hangers. The total height including grid is at least 150 mm. The ceiling canopy is attached via at least four suspension points using metal dowels approved by the building authorities, suitable threaded rods, chains or steel cables in accordance with the manufacturer's specifications and the static requirements. Other suspension designs are possible using special hangers. The vertical or angled upstand of the ceiling canopy and individual arrangement options in the room give you a wide range of design options. For example, when using expanded metal, louvre or lattice steel ceiling elements with a free cross-section from approx. 70 % without loss of performance.

#### 2. Installation of the aquatherm energy grid

The grids for the "free convection" system are fitted with 45° plug-in connections **on the left and right (one-sided)**. This ensures a uniform flow.

Installation must be carried out in accordance with the recognised rules of technology, generally applicable standards and regulations as well as the manufacturer's instructions. To do this, the grids are placed in the ceiling sails according to the installation plan and fixed in place with small black cable ties if necessary.

Depending on requirements, mineral wool insulation (min. 30 mm, shrink-wrapped in PE film) can be placed on the grids. Installation must be carried out in accordance with the provisions of DIN EN 13964. Ensure that the installation is horizontal and flush.

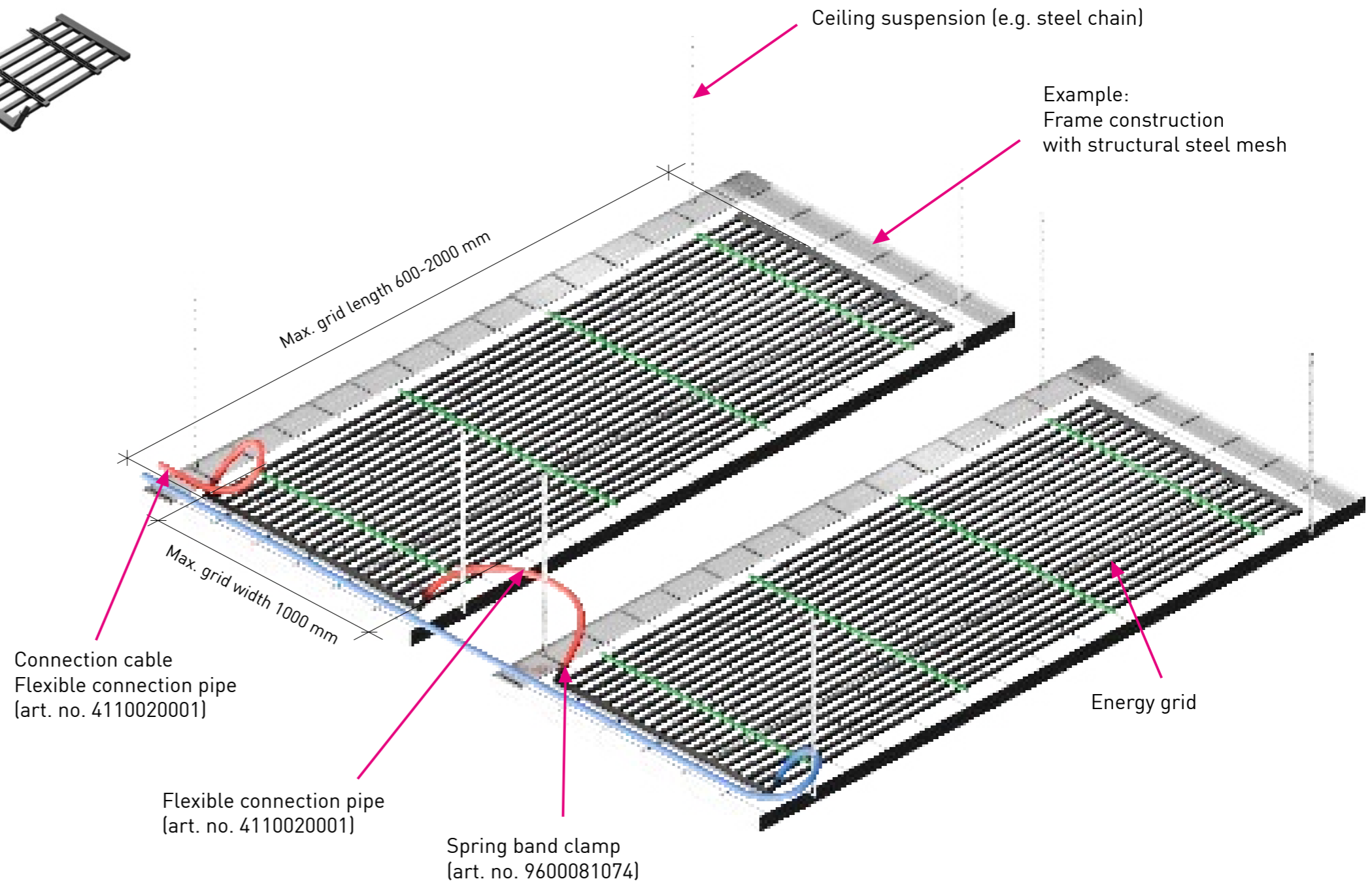

Special dimensions on request



# Ceiling system: Free convection - suspended \_\_\_ Plug-in terminals

### ASSEMBLY DESCRIPTION

#### Grid with push-fit connection 45° left, right (one-sided)

CONNECTION TYPE 43

### 3. Connection of the aquatherm energy grids

Once the grids have been installed in the ceiling canopy on the ceiling, they are hydraulically connected to form heating or cooling zones in accordance with the installation plan. The Flexible connection pipe 20 x 3.4 mm with our spring band clamps is used for this (see connection detail).

#### Notes:

The material of the substructure and the metal ceiling system must be provided by the customer. When connecting the energy grids to each other, from sail to sail, the flex. connection pipe must be secured against sagging depending on the distances to each other (e.g. using aquatherm black plastic fastening clips). Connection pipe must be secured against sagging (e.g. using aquatherm black plastic fastening clamps).

### Detail: Connection pipework between the grids



- 1. Flexible connection pipe (art. no. 4110020001)  
Length depending on the distances between the sails to each other; but min. 750 mm
- 2. Spring band clamp (art. no. 9600081074)

### Section: Fixing the ceiling grid

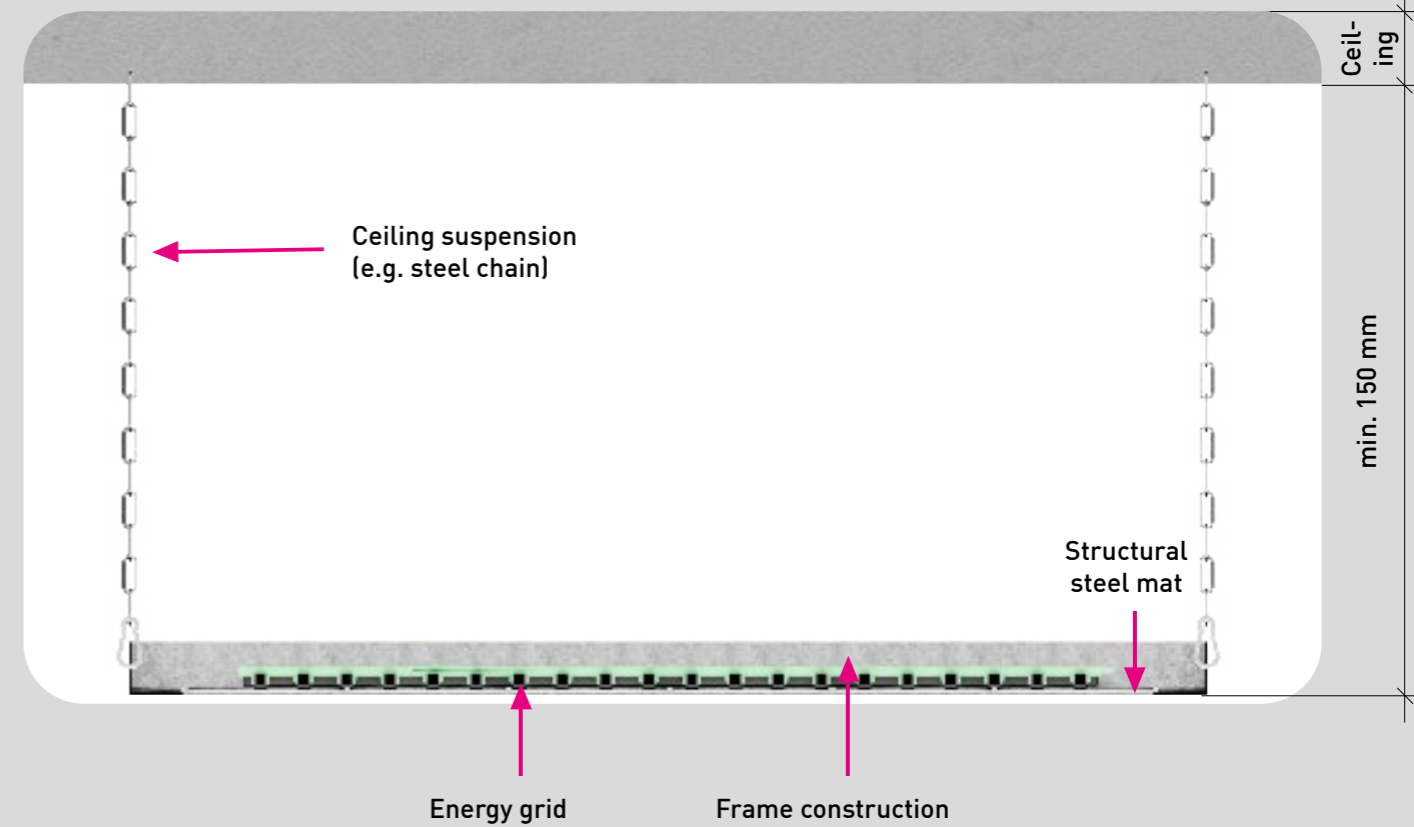

### Detail: Alternative support surfaces

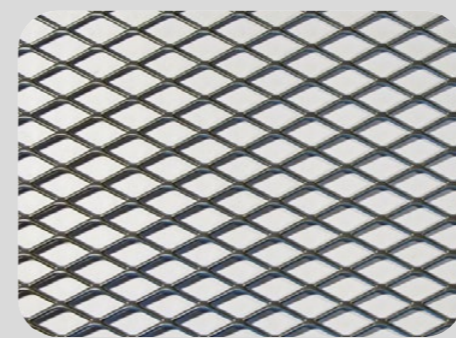

Expanded metal (for free convection) with at least 70% free cross-section

### Detail: Alternative support surfaces

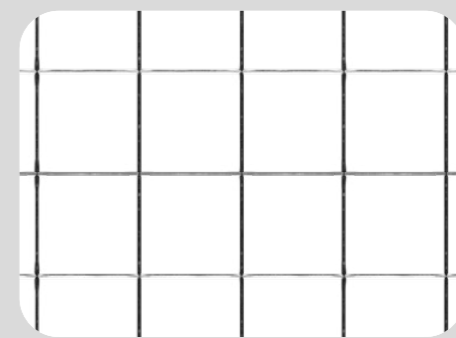

Wire mesh in various wire thicknesses and mesh sizes





## Ceiling system: Free convection - suspended Welding

### ASSEMBLY DESCRIPTION

**Grid with welded connection socket left, right (one-sided)**

CONNECTION TYPE 45

#### 1. Suspension sail

The ceiling sails are connected to the bare ceiling by ceiling hangers. The total height including grid is at least 150 mm. The ceiling canopy is attached via at least four suspension points using metal dowels approved by the building authorities, suitable threaded rods, chains or steel cables in accordance with the manufacturer's specifications and the static requirements. Other suspension designs are possible using special hangers. The vertical or angled upstand of the ceiling canopy and individual arrangement options in the room give you a wide range of design options. For example, when using expanded metal, louvre or lattice steel ceiling elements with a free cross-section from approx. 70 % without loss of performance.

#### 2. Installation of aquatherm heating and cooling grids

The grids for the "free convection" system are fitted with welding sockets (welding connection socket left / right).

Installation must be carried out in accordance with the recognised rules of technology, generally applicable standards and regulations as well as the manufacturer's instructions. To do this, the grids are placed in the ceiling sails according to the installation plan and fixed in place with small black cable ties if necessary.

Depending on requirements, mineral wool insulation (min. 30 mm, shrink-wrapped in PE film) can be placed on the grids. Installation must be carried out in accordance with the provisions of DIN EN 13964. Ensure that the installation is horizontal and flush.

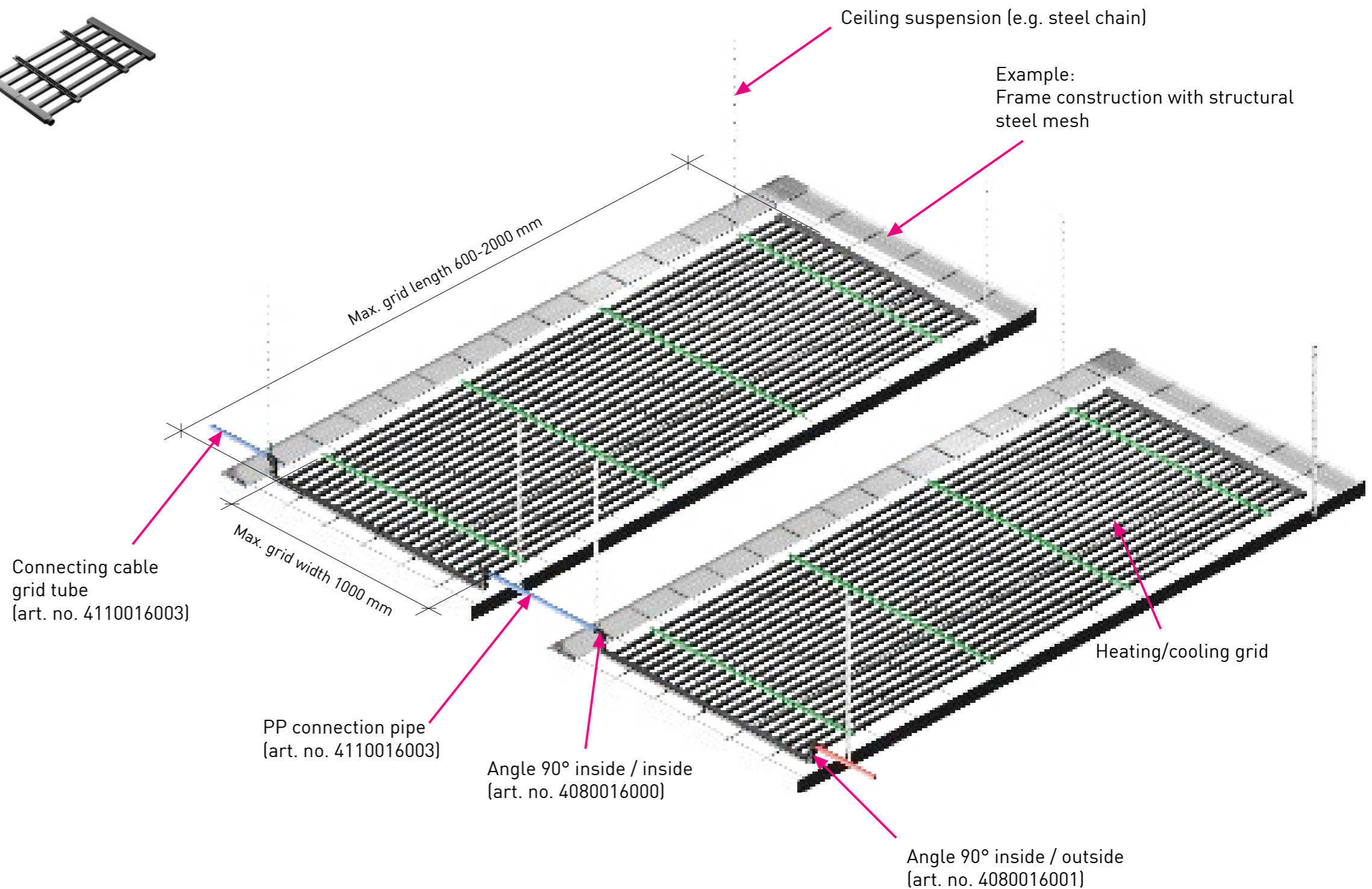

**Special dimensions on request**



## Ceiling system: Free convection - suspended Welding

### ASSEMBLY DESCRIPTION

#### Grid with welded connection socket left, right (one-sided)

CONNECTION TYPE 45

### 3. Connection of the aquatherm heating and cooling grid

Once the grids have been installed in the ceiling canopy on the ceiling, they are hydraulically connected to form heating or cooling zones in accordance with the installation plan. The heating or cooling circuits are connected to the manifold or the main pipework using aquatherm black grid pipe 16x2 mm. (see connection details).

#### Note:

The material for the substructure and the metal ceiling are not included in aquatherm's scope of delivery and must therefore be procured by the customer.

### Detail: Connection pipework between the grids



1. PP connection pipe (art. no. 4110016003)
2. Angle 90° inside / outside (art. no. 4080016001)
3. Angle 90° inside / inside (art. no. 4080016000)

### Section: Fixing the ceiling grid

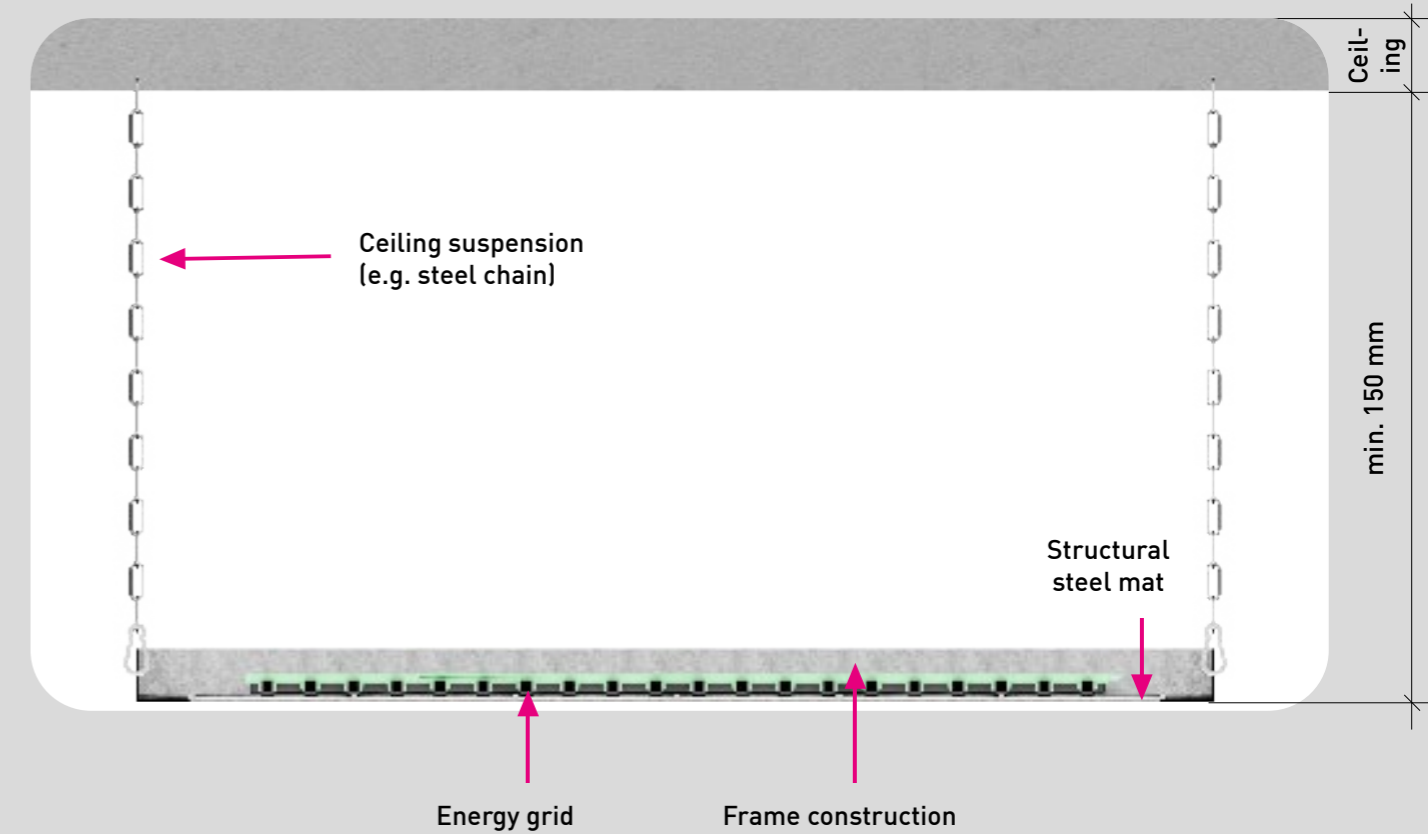

### Detail: Alternative support surfaces

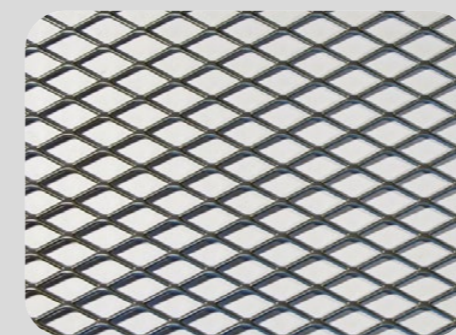

Expanded metal (for free convection) with at least 70% free cross-section

### Detail: Alternative support surfaces

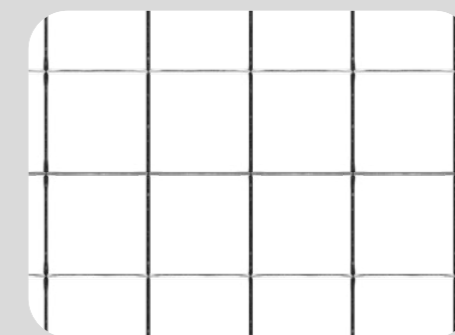

Wire mesh in various wire thicknesses and mesh sizes





## Ceiling system: Free convection - direct mounting \_\_\_

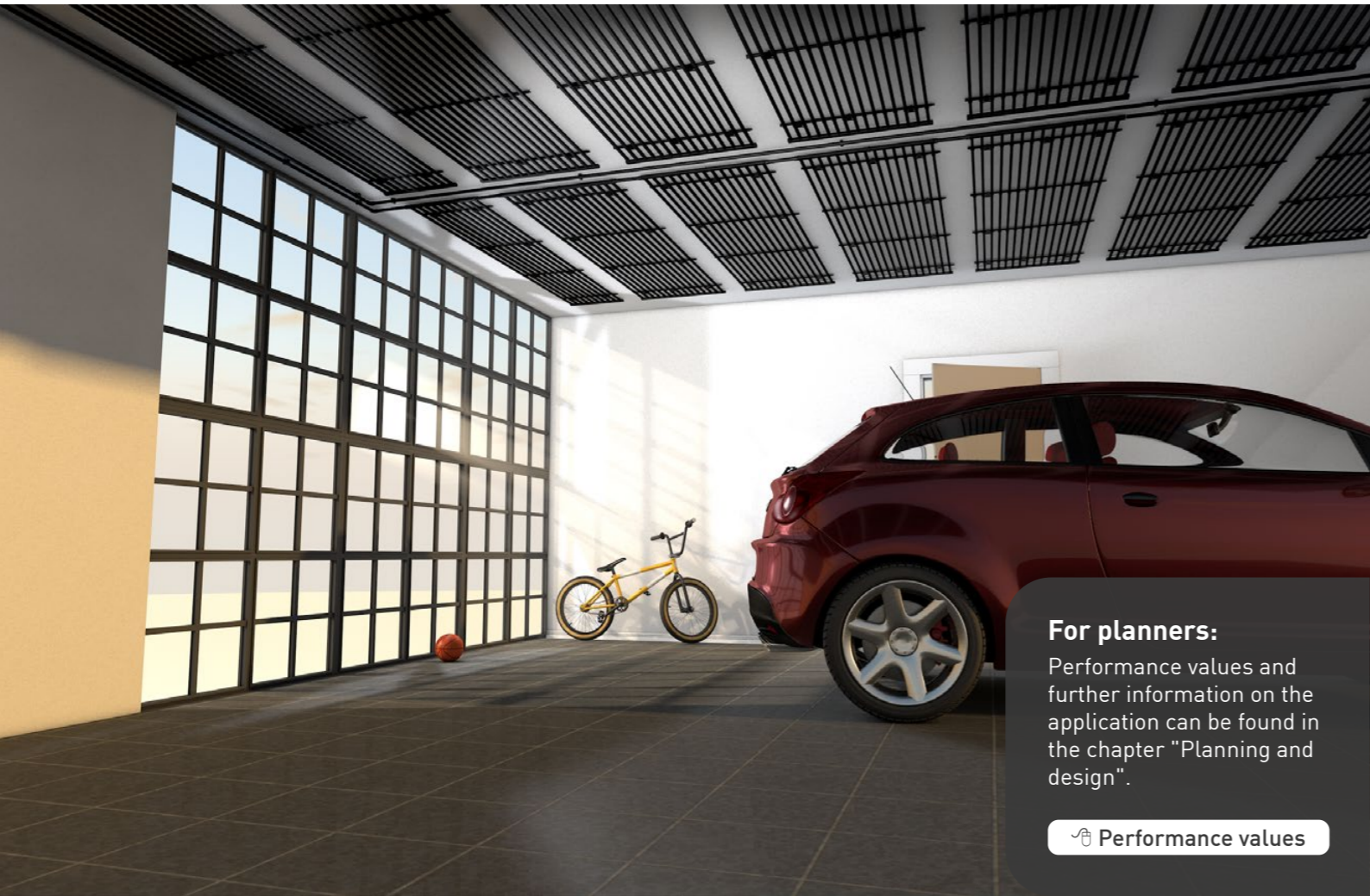

### For planners:

Performance values and further information on the application can be found in the chapter "Planning and design".

[Performance values](#)

### Advantages:

- High heating and cooling performance thanks to free convection.
- Can be used variably.
- Even temperature distribution.
- Power output without draughts.



### System description

Free convection offers a high heating and cooling capacity due to the unhindered air circulation. It is suitable for heating individual workstations in the industrial sector, for example. The aquatherm black heating and cooling grids are installed directly on the concrete ceiling. The available grid sizes allow variable adaptation to the spatial conditions.

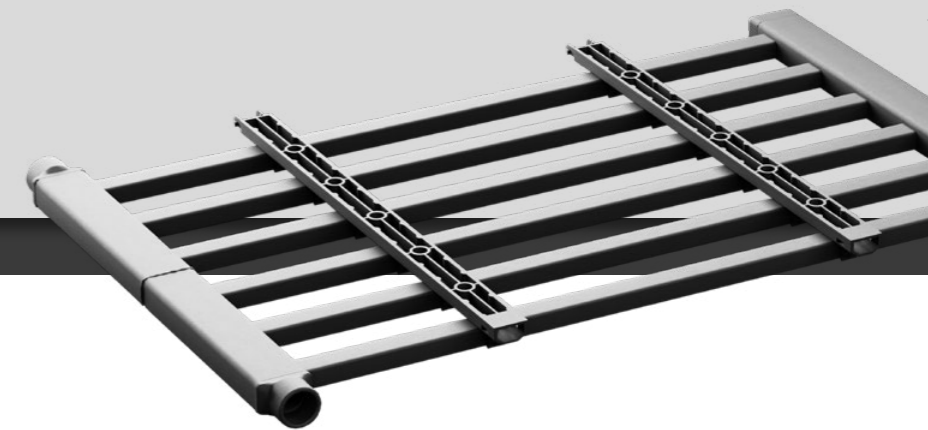



## Ceiling system: Free convection - direct mounting

### ASSEMBLY DESCRIPTION

**Grid with welded connection socket left, right (one-sided)**

CONNECTION TYPE 45

#### 1. Installation of aquatherm heating and cooling grids

The aquatherm black grids for installation under the ceiling are supplied with welding sockets (**welding connection socket left / right**) in one-sided design. They are installed directly on the underside of the ceiling.

The grids are installed on the bare ceiling using the supplied fastening elements with dowels in accordance with the installation plans.

**We recommend using at least 8 fastening elements with dowels per m<sup>2</sup> of grid surface.**

#### 2. Connection of the aquatherm heating and cooling grids

When arranging the grids, the flow can be connected either on the left or right. After installing the grids on the bare ceiling, they are connected to each other to form heating or cooling circuits in accordance with the installation plan.

#### 3. Connection pipework of the aquatherm black heating and cooling grid to the distribution system

The heating or cooling circuits are connected to the manifold or the main pipework using aquatherm black 16x2 mm grid pipe. The connecting pipe should also be fastened to the bare ceiling (e.g. with aquatherm black plastic fastening clamps).

#### Note:

Alternatively, we recommend fastening the grids and connecting cables with a bolt fastening device.

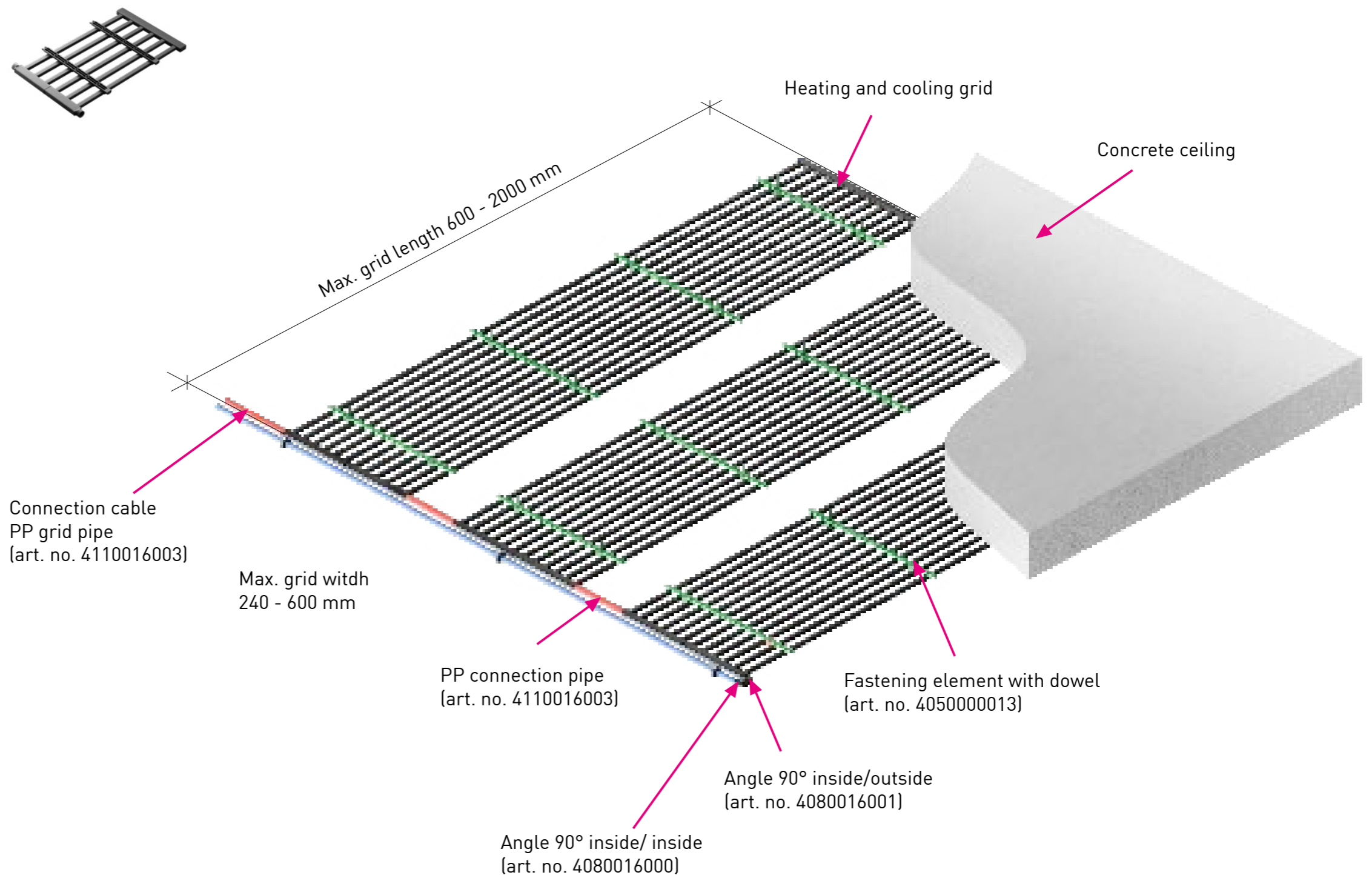

Special dimensions on request





## Ceiling system: Free convection - direct mounting \_\_\_

Detail: Fastening of the connection pipework

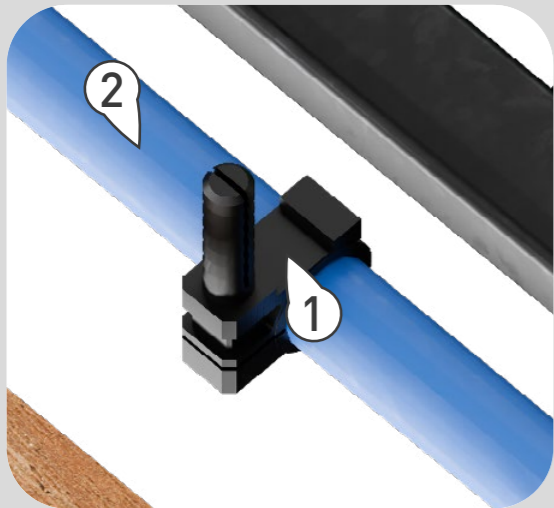

- 1. Plastic fastening clip (art. no. 4090016006)
- 2. Connection cable PP grid pipe (art. no. 4110016003)

Detail: Grid fastening for concrete ceilings

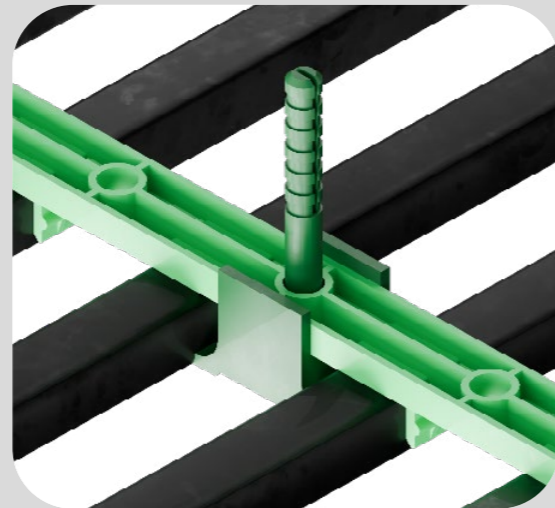

Use of fixing element with dowel (art. no. 4050000013)  
8 x per m<sup>2</sup>

Detail: Grid fastening for wooden ceilings



Use fastening element with dowel (art. no. 4050000013) for wooden ceilings  
dowel is cut off

Section: Fixing the ceiling grid

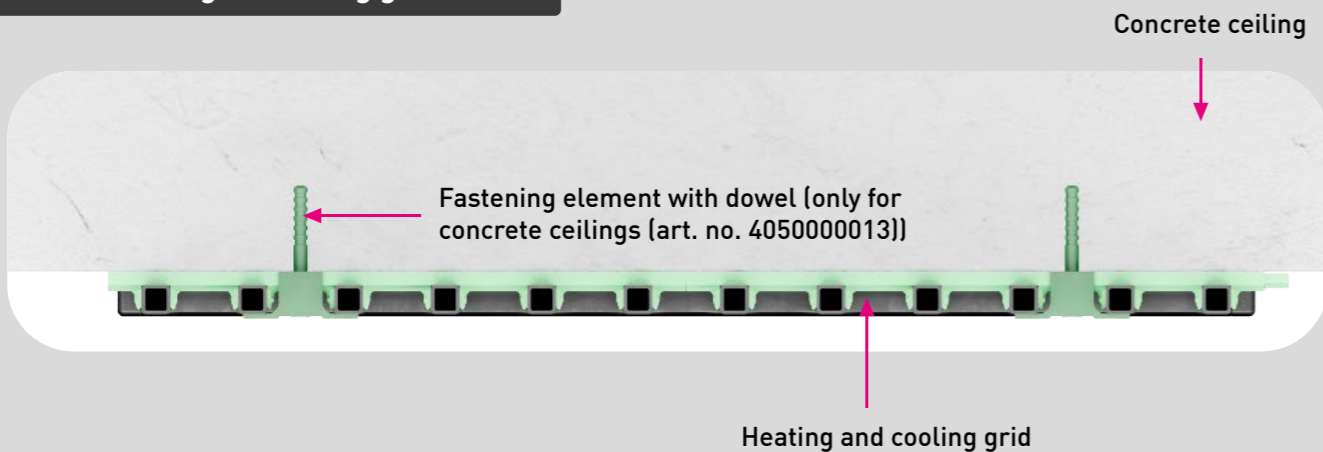



## Wall system: Metal stud frame and panelling with building boards \_\_



### Advantages:

- High heating and cooling capacity.
- Quick and easy installation.
- Combination with centrally treated outside air possible.
- Combination of thermally active and passive wall elements possible.
- Rapid construction progress thanks to dry construction system.

Wall



### System description

Walls with metal substructure and panelling with building boards offer individual design options with cost-effective execution. In conjunction with aquatherm black energy grids, the ideal combination of a drywall system with an energy-saving heating system.

To install the aquatherm black energy grids, only the panelling process is briefly interrupted.

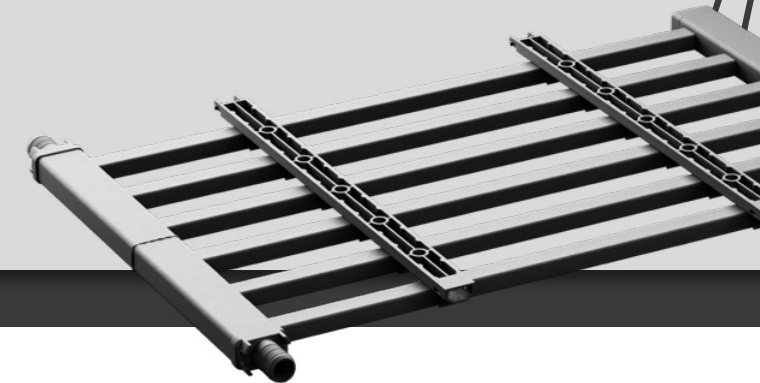





# Wall system: Metal stud frame and panelling with building boards

## ASSEMBLY DESCRIPTION

Grid with push-fit connection left, right (one-sided)

CONNECTION TYPE 46



### 1. Assembly of the stud frame (on site)

The metal support structure must be installed in accordance with the recognised rules of technology, generally applicable standards and regulations and the manufacturer's instructions. The metal support structure must be installed in accordance with the provisions of DIN 18182-1 and care must be taken to ensure that there are no electrical, water or heating pipes on the floor when installing the UW frame profiles. Alternatively, the profiles can also be glued. The CW profiles are then placed vertically in the UW profiles and fastened. Furthermore, care must be taken to ensure horizontal and aligned installation.

Any insulation required in accordance with fire protection or sound insulation requirements should also be installed. Mineral wool is recommended as an insulating material. It is important that the thickness of the insulation mat matches the profile dimensions. Once the gap has been insulated, the installation of the black energy grids can begin.

Data for planning the wall grids		
a		
Standard width metal stud frame mm	Grid width mm	Grid length mm
625	480	600 - 2000 mm
500	320	
Centre distance b min 320 mm, minimum width for smallest grid: 240 mm		
Special dimensions on request		

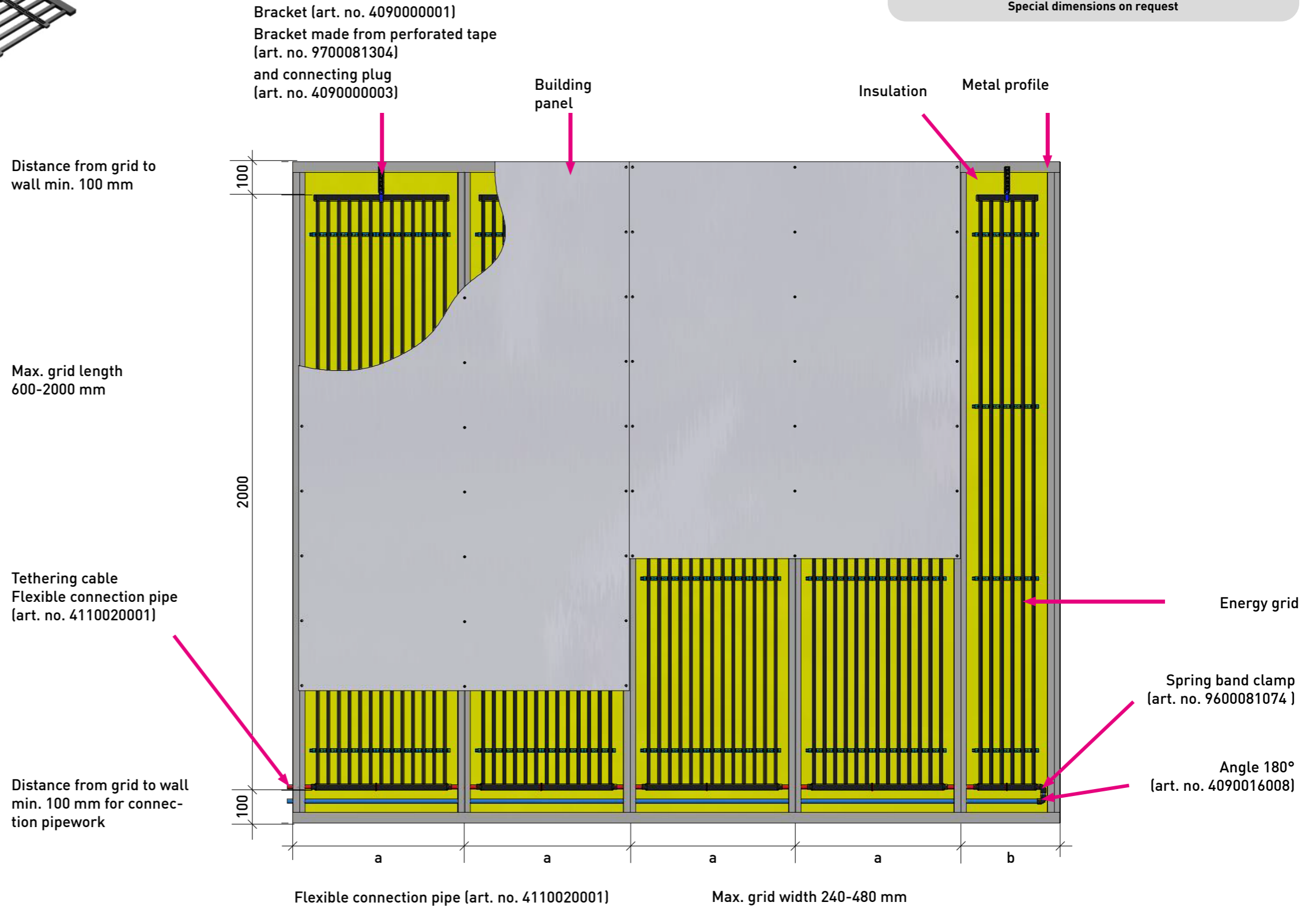



## Wall system: Metal stud frame and panelling with building boards

### ASSEMBLY DESCRIPTION

#### Grid with push-fit connection left, right (one-sided)

CONNECTION TYPE 46

#### 2. Installation of the aquatherm black energy grid

The grid width of 480 mm is adapted to the standard grid dimensions of the metal stud wall. The grids are installed between the CW profiles in accordance with the installation plan. The specifications of the manufacturer of the building boards used must be observed. The grids must be fastened between the profiles in accordance with the installation plan. To do this, the plastic-coated perforated strip is shortened to length and fitted to the upper UW profile using connecting plugs with the aquatherm black brackets. All the necessary components are available as aquatherm black accessories.

#### 3. Connection of the aquatherm black energy grid

The grids are equipped with a push-fit connection on the left and right (one-sided). Once the grids have been installed in the metal structure, they are connected to form heating and cooling zones in accordance with the installation plan. The Flexible connection pipe 20 mm x 3.4 mm with our spring band clamps is used for this purpose (see connection pipework detail). The H-punching provided for this purpose is bent open for the pipe penetrations in the metal stud frame. The H-punchings should be at the same height for all profiles. The required web cut-outs in the metal stud frame depend on the profile height and type and must always be created in accordance with the manufacturer's instructions.

When installing the connection/feed lines through the H-punched holes in the metal profiles, care must be taken not to damage the surface of the connection/feed lines.

If necessary, corrugated pipe, protective pipe or insu-

#### Detail: Fixing wall grid

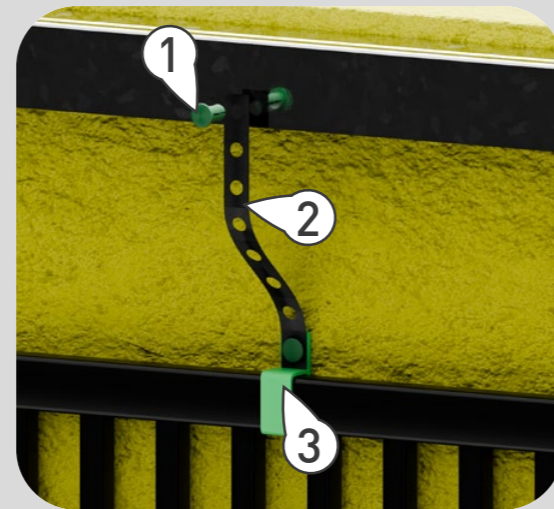

1. Connection plug  
(art. no. 4090000003)
2. Perforated tape  
(art. no. 9700081304)
3. Bracket  
(art. no. 4090000001)  
1x fastening per wall grid

#### Detail: H-punch in metal profile for connection pipework

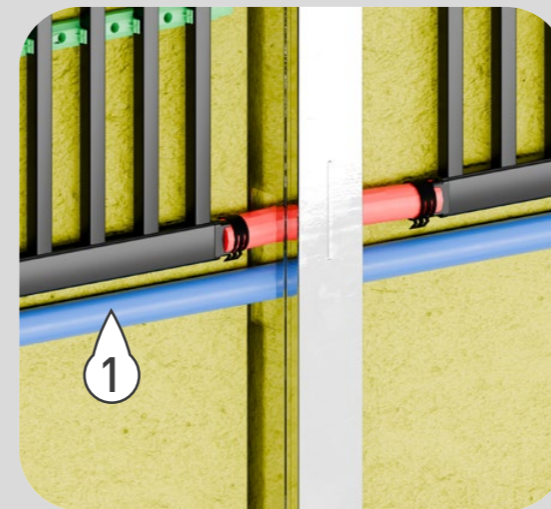

1. Connection cable  
(art. no. 4110020001)





## Wall system: Metal stud frame and panelling with building boards

### ASSEMBLY DESCRIPTION

#### Grid with push-fit connection left, right (one-sided)

CONNECTION TYPE 46

lating hose must be used on site to protect the pipes.

#### 4. Connection pipework of the aquatherm black energy grid to the distribution system

The connection of the heating/cooling circuits from the manifold or the main pipework is routed into the room, e.g. through the wall/ceiling, in accordance with the applicable regulations. The Flexible connection pipe 20 x 3.4 mm can be used for this. We recommend fastening the connecting pipes with plastic fastening clamps in accordance with our specifications.

#### 5. Assembly of the building boards (on site)

The construction panels are mounted on the CW profiles of the metal stud wall in accordance with the manufacturer's instructions. It must be ensured that the grids are filled with water (or the corresponding medium) during installation of the building boards and are under system pressure. Installation must be carried out in accordance with the provisions of DIN 18180.

#### Notes:

The use of wallpaper, nonwovens and acoustic plasters leads to a reduction in heating and cooling performance.

The material for the substructure and the building boards must be provided by the customer.

### Detail: Connection pipework

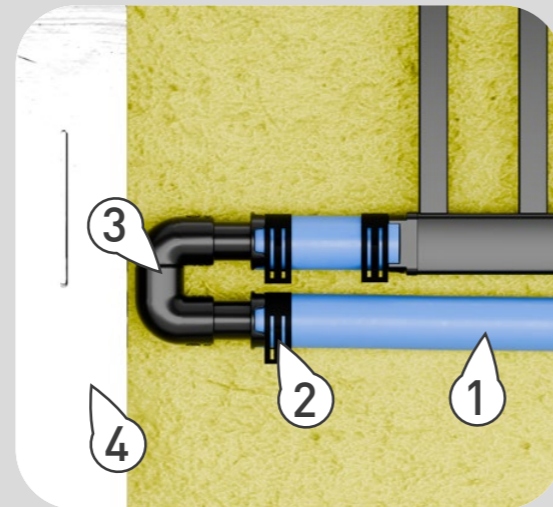

1. Flexible connection pipe (art. no. 4110020001)
2. Spring band clamp (art. no. 9600081074)
3. Angle 180° (art. no. 4090016008)
4. Metal profile

### Detail: panelling with building boards

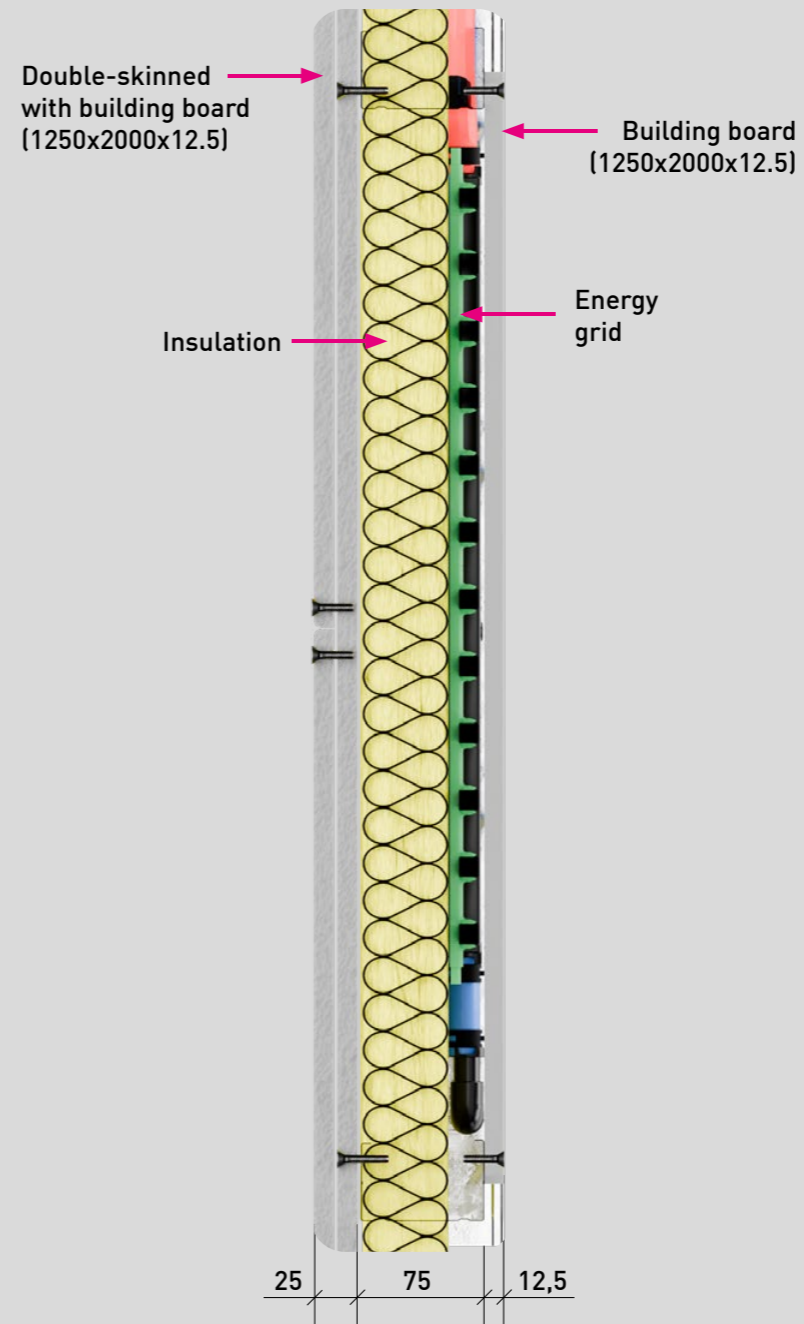



## Wall system: Metal stud frame and panelling with building boards

### ASSEMBLY EXAMPLE

#### Laying building boards

Plasterboard wall system - single-layer vertical panelling

Centre distance support profile = 500 & 625 mm

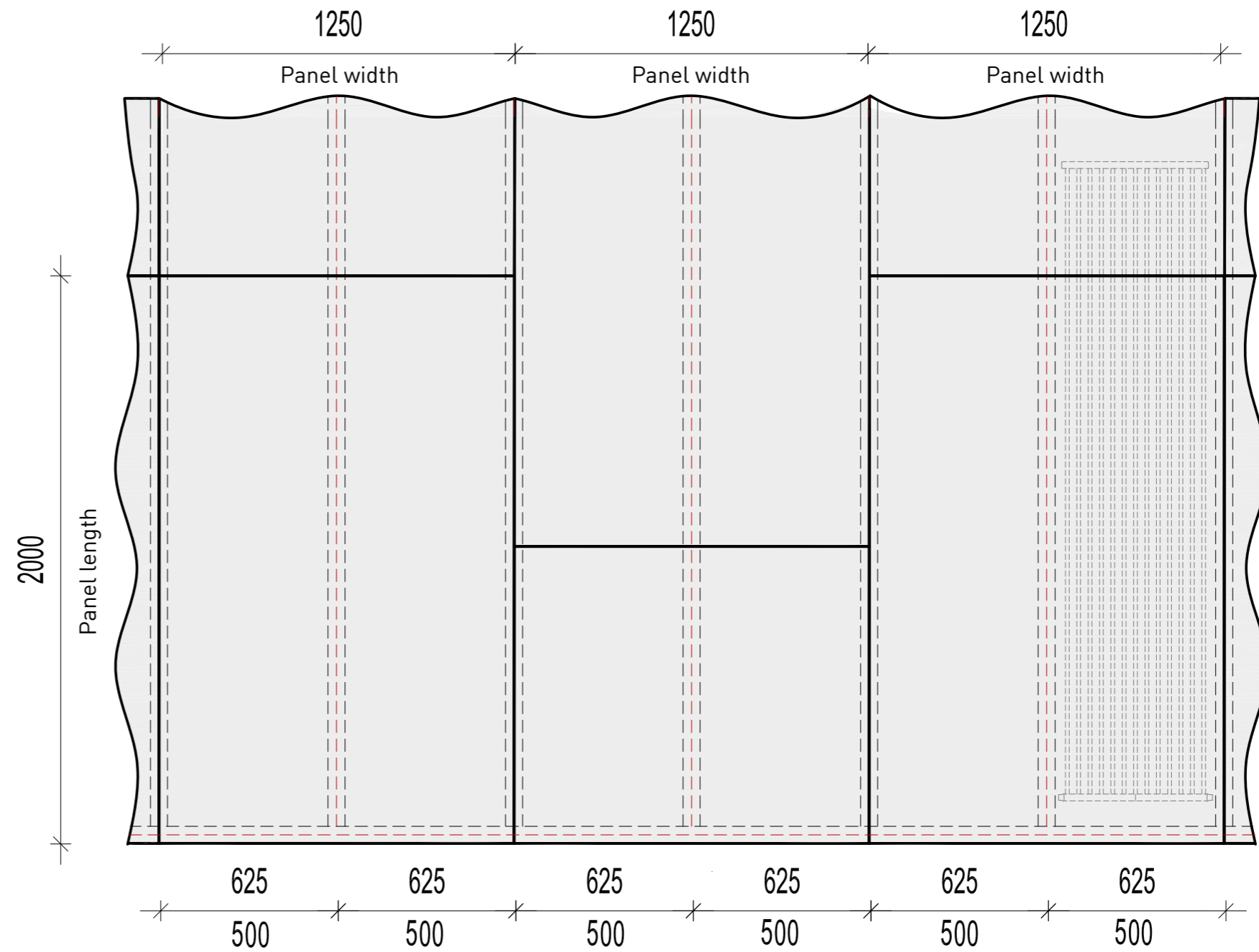





## Wall system: Timber stud frame and panelling with building boards



### Advantages:

- High heating and cooling capacity.
- Even temperature distribution.
- Quick and easy installation.
- Combination with centrally treated outside air possible.
- Power output without draughts.
- Short heat-up and fast response times.
- Rapid construction progress thanks to dry construction system.

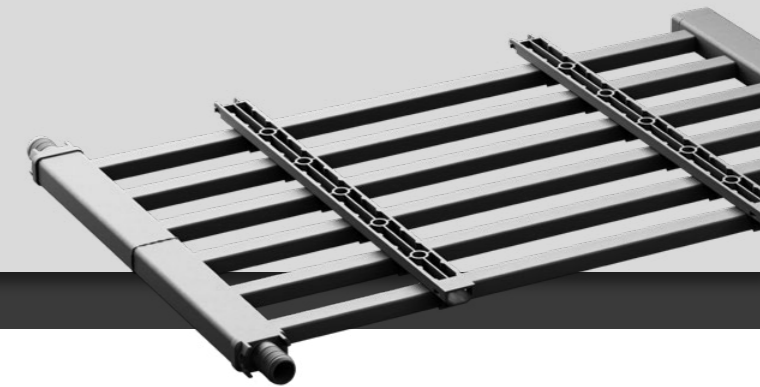

### System description

Walls with a wooden substructure and panelling with building boards offer individual design options with cost-effective execution. In conjunction with aquatherm black energy grids, the ideal combination of a drywall system with an energy-saving heating system.

To install the aquatherm black energy grids, only the panelling process is briefly interrupted.



# Wall system: Timber stud frame and panelling with building boards

## ASSEMBLY DESCRIPTION

### Grid with push-fit connection left, right (one-sided)

CONNECTION TYPE 46



#### 1. Assembly of the stud frame (on site)

The installation of the timber support structure must be carried out in accordance with the recognised rules of technology, generally applicable standards and regulations as well as the manufacturer's instructions. The timber support structure must be executed in accordance with the provisions of DIN 18182-1. Make sure that there are no electrical, water or heating pipes on the floor when installing the wooden profiles. Alternatively, the profiles can also be glued. Furthermore, care must be taken to ensure horizontal and aligned installation.

Any insulation required in accordance with fire protection or sound insulation requirements should also be installed. Mineral wool is recommended as an insulating material. It is important that the thickness of the insulation mat matches the profile dimensions. Once the gap has been insulated, installation of the black energy grids can begin.

Data for planning the wall grids		
a		
Standard width timber stud frame mm	Grid width mm	Grid length mm
625	480	600 - 2000 mm
500	320	
Centre distance b min 320 mm, minimum width for smallest grid: 240 mm		
Special dimensions on request		

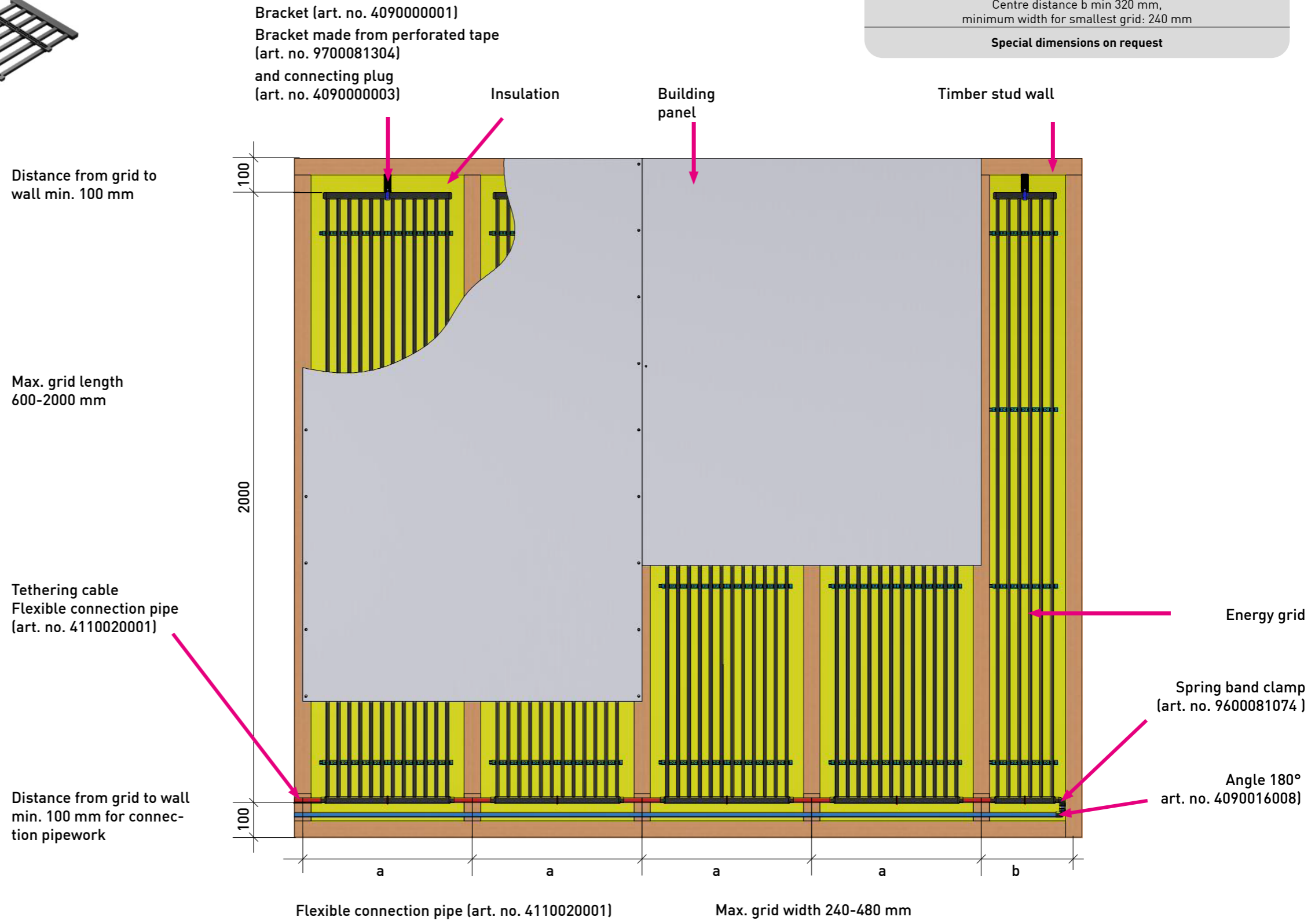





## Wall system: Timber stud frame and panelling with building boards

### ASSEMBLY DESCRIPTION

#### Grid with push-fit connection left, right (one-sided)

CONNECTION TYPE 46

#### 2. Installation of the aquatherm black energy grid

The grid width of 480 mm is adapted to the standard grid dimensions of the timber stud wall. The specifications of the manufacturer of the building boards used must be observed. The grids must be fastened between the profiles in accordance with the installation plan. For this purpose, the plastic-coated perforated strip is shortened to length and mounted to the upper timber profile using connecting plugs with the aquatherm black brackets. All the necessary components are available as aquatherm black accessories.

#### 3. Connection of the aquatherm black energy grid

The grids are equipped with a push-fit connection on the left or right side (one-sided).

Once the grids have been installed in the timber stud frame, they are connected to form heating and cooling zones in accordance with the installation plan.

The Flexible connection pipe 20 mm x 3.4 mm with our spring band clamps is used for this (see connection detail).

Recesses must be provided in the wooden profiles for the pipe penetrations. These should be at the same height for all profiles.

When installing the connection/feed lines through the recesses in the wooden profiles, make sure that the surface of the connection/feed lines is not damaged. If necessary, corrugated pipe, protective pipe or insulating hose must be used on site to protect the pipes.

#### Detail: Fixing wall grid

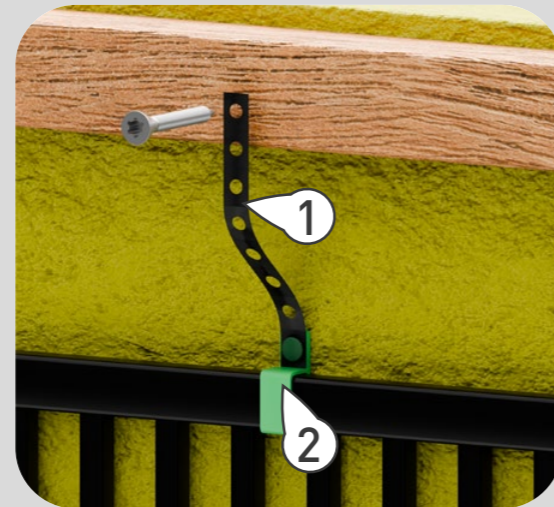

1. Perforated tape  
(art. no. 9700081304)
2. Bracket  
(art. no. 4090000001)  
1x fastening per wall grid

#### Detail: H-punch in metal profile for connection pipework

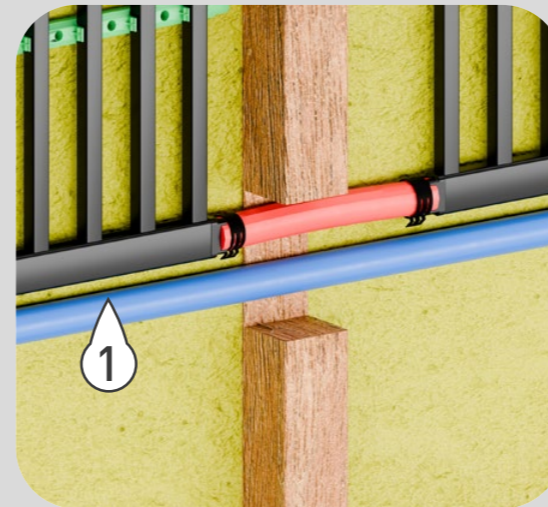

1. Connection cable  
(art. no. 4110020001)



## Wall system: Timber stud frame and panelling with building boards

### ASSEMBLY DESCRIPTION

#### Grid with push-fit connection left, right (one-sided)

CONNECTION TYPE 46

#### 4. Connection pipe work of the aquatherm black grid to the distribution system

The connection of the heating/cooling circuits from the manifold or the main pipework is routed into the room, e.g. through the wall/ceiling, in accordance with the applicable regulations. The Flexible connection pipe 20 x 3.4 mm can be used for this. We recommend fastening the connecting pipes with plastic fastening clamps in accordance with our specifications.

#### 5. Assembly of the building boards (on site)

The building boards are fitted to the timber profiles of the stud wall in accordance with the manufacturer's instructions. It must be ensured that the grids are filled with water (or the corresponding medium) during installation of the building boards and are under system pressure. Installation must be carried out in accordance with the provisions of DIN 18180.

#### Notes:

The use of wallpaper, nonwovens and acoustic plasters leads to a reduction in heating and cooling performance.

The material for the timber stud wall and the building boards must be provided by the customer.

### Detail: Connection pipework

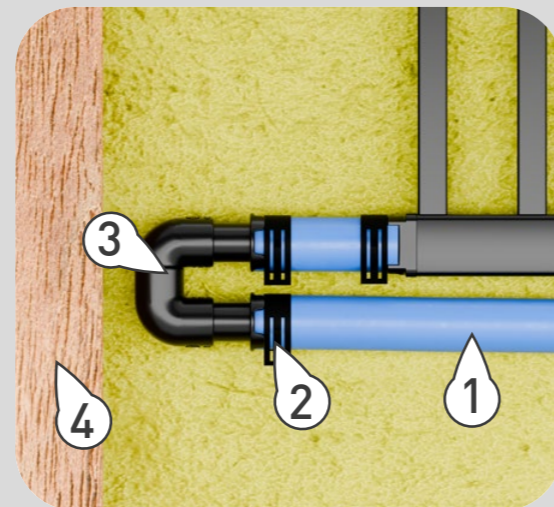

1. Flexible connection pipe (art. no. 4110020001)
2. Spring band clamp (art. no. 9600081074)
3. Angle 180° (art. no. 4090016008)
4. Timber stud wall

### Detail: panelling with building boards

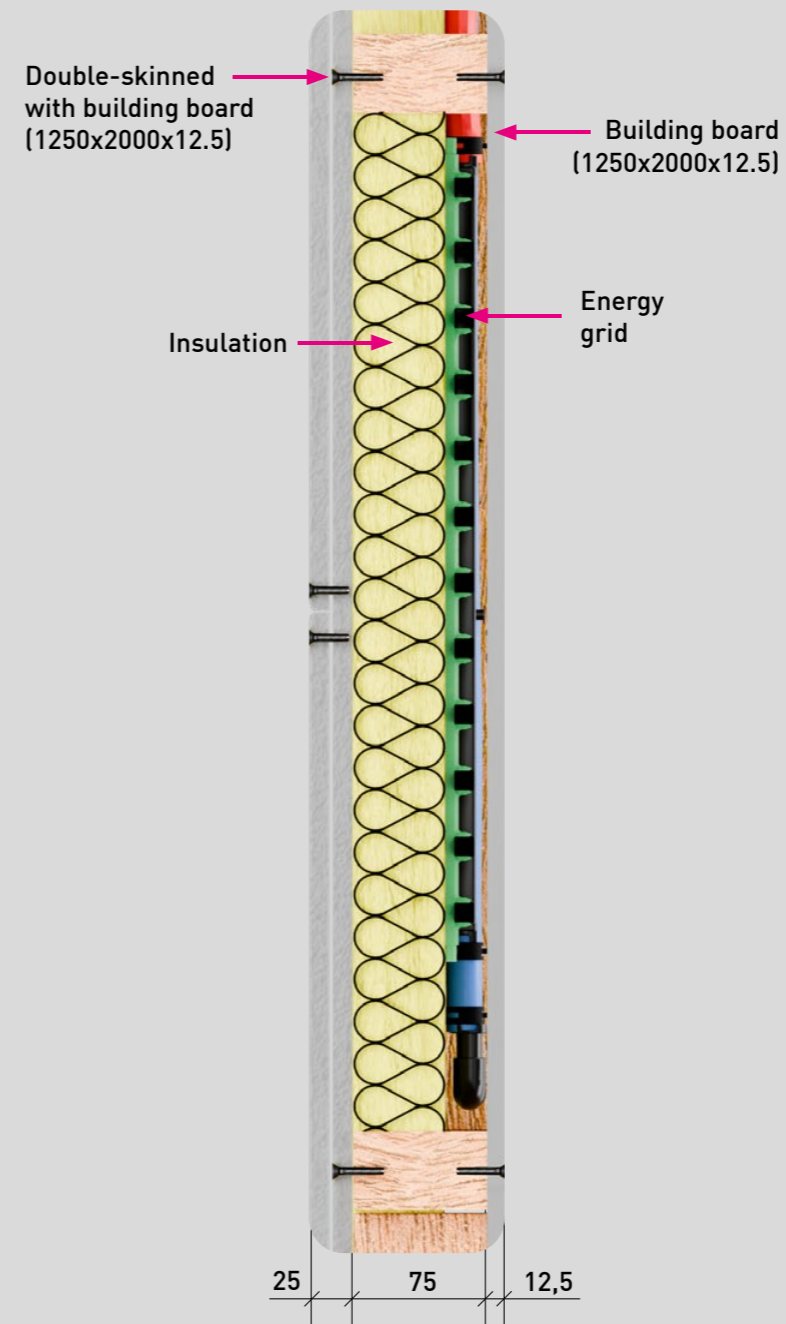





## Wall system: Timber stud frame and panelling with building boards

### ASSEMBLY EXAMPLE

#### Laying building boards

Plasterboard wall system - single-layer vertical panelling

Centre distance support profile = 500 & 625 mm

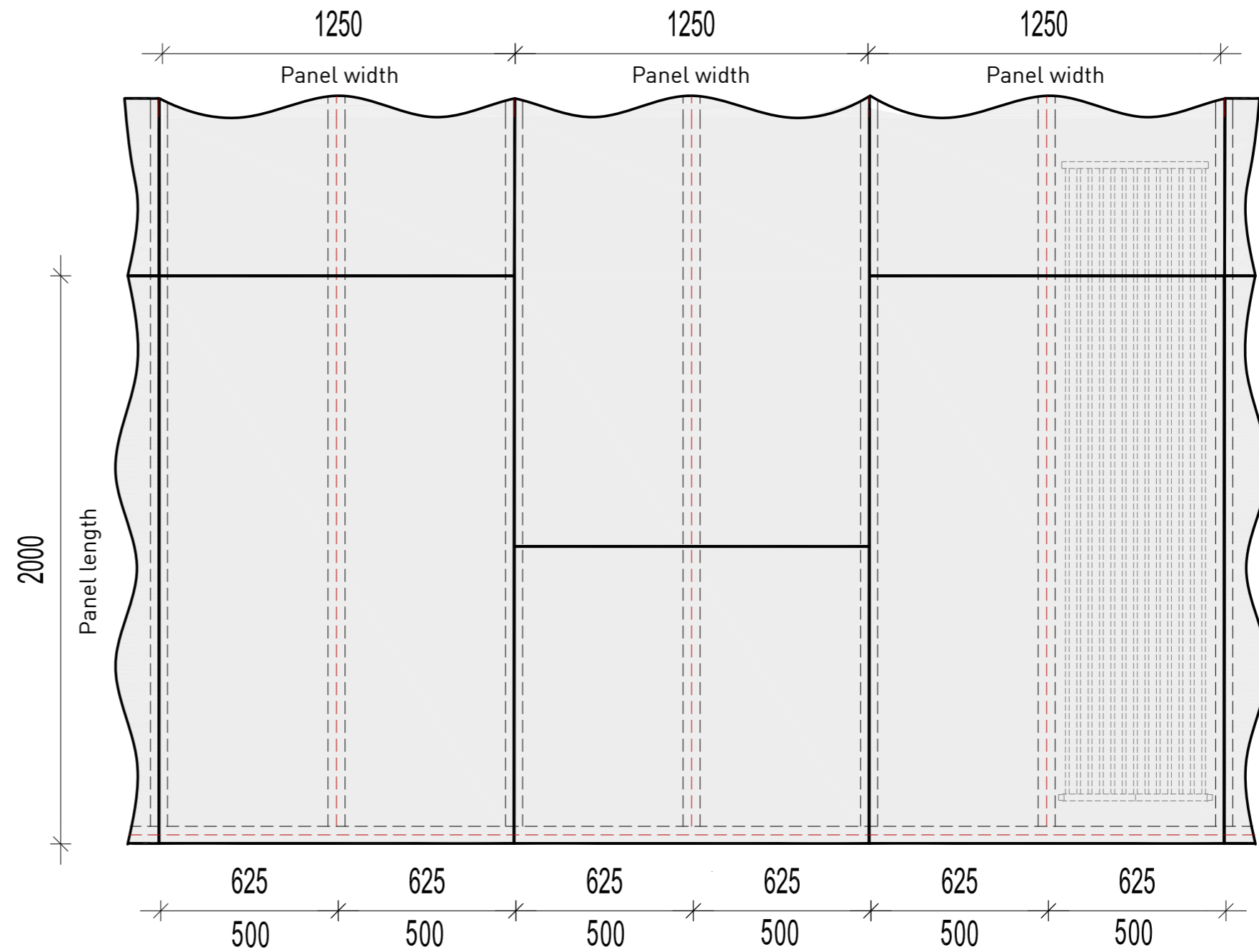



## Wall system: Plastered in \_\_\_



### Advantages:

- High heating and cooling capacities thanks to the large thermal transfer surface of the square-edged grid profiles.
- Silent, draught-free heating and cooling function.
- Efficient use of heat pumps and renewable energies.
- Short heat-up and fast response times.
- Quick and easy attachment.
- Pleasant room climate.
- Can be installed on many ceiling surfaces.



### System description

The design freedom is a big plus point here. The aquatherm black heating and cooling grids can be customised in shape and dimensions to suit any room geometry. The grids and the connection pipework are fixed to the wall. Plastering is then carried out in accordance with the general plastering guidelines.

All commercially available plasters made of gypsum, lime, cement and clay are suitable for this purpose.

### Surface temperature:

- Maximum surface temperature in heating mode is 40 °C
- Recommended surface temperature for optimum comfort is approx. 33 °C
- Minimum surface temperature in cooling mode: 18 °C
- Maximum flow temperature at 50 °C
- Standard system temperatures are not critical for plasters in cooling or heating mode
- Dew point monitoring prevents condensation and moisture damage is avoided





## Wall system: Plastered

### ASSEMBLY DESCRIPTION

Grid with welded connection  
Socket left, right (one-sided)

CONNECTION TYPE 45



### 1. Requirements for the substrate

To prepare the substrate, we recommend using a suitable primer to create a non-slip substrate in accordance with the manufacturer's instructions. Furthermore, the substrate must be dust-free, free of loose particles, oil, grease, formwork release agents and post-treatment agents, sintered layers, soiling and harmful efflorescence and meet the requirements for the evenness of component surfaces in accordance with DIN 18202.

### 2. Installation of aquatherm heating and cooling grids

The shelves are attached to the raw wall using the supplied fastening elements with dowels in accordance with the installation plans. The fastening element is attached to the wall using the fastening rail mounted on the grid.

We recommend using at least 8 fastening elements with dowels per m<sup>2</sup> of grid surface.

### Please note the following:

Depending on the plaster substrate, type and manufacturer, the fixing element with dowels can be used as a plaster base in conjunction with the fixing rail during wall installation. Additional plaster base supports (reinforcing mesh) in the area of the grids can be omitted. However, it must be ensured that the necessary measures are taken in the plaster areas without grids.

For wall heating and cooling systems, the use of plaster supports for additional fastening and installation has proven its worth. Plaster bases must be fastened to the surface at a grid spacing of 500 mm. In exceptional cases, depending on the geometry of the reinforcement mesh, grid spacings of 400x600 mm can also be used for wall heating and cooling systems. The distance to boundary components or edge surfaces must not exceed 250 mm. The plaster manufacturer's processing guidelines are binding and must be observed!

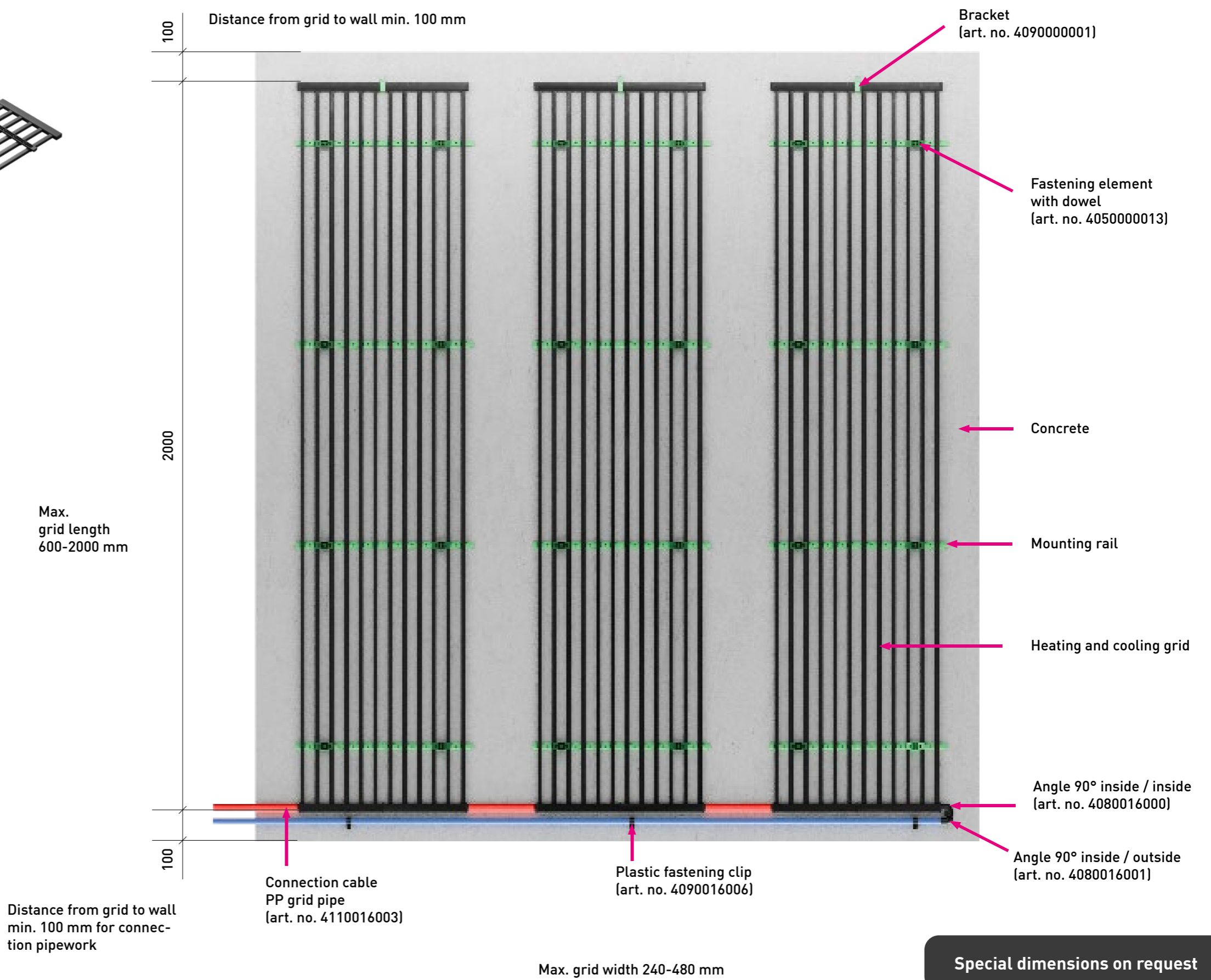

Special dimensions on request



## Wall system: Plastered in \_\_\_

### ASSEMBLY DESCRIPTION

#### Grid with welded connection Socket left, right (one-sided)

CONNECTION TYPE 45

#### 3. Connection of the aquatherm black heating and cooling grid

When arranging the grids, the flow can be connected either on the left or right. The grids for installation in a wall system with plaster are fitted with welding sockets (welding connection socket left, right). After installing the grids on the unfinished wall, they are connected to each other to form heating or cooling zones in accordance with the installation plan.

#### 4. Connection pipework of the aquatherm black heating and cooling grid to the distribution system

The heating or cooling circuits are connected to the manifold or the main pipework using aquatherm black 16x2 mm grid pipe. This can be plastered in if it has also been fastened to the raw wall (e.g. with aquatherm black plastic fastening clips). Alternatively, we recommend fastening the grids and connecting cables with a bolt fastening device.

#### 5. Plastering the aquatherm heating and cooling grids

The wall can now be pre-plastered up to the top edge of the grid. After the drying times specified by the manufacturer, the plaster covering (max. 10 mm) can be applied from the top edge of the heating pipe (in accordance with the manufacturer's instructions). It must be ensured that the grids are filled with water (or the corresponding medium) during plastering and are under system pressure. The aquatherm plastering guidelines must also be observed.

#### Notes:

Depending on the application of the plaster, the manufacturer may specify a wall primer or the application of a plaster base. The respective plaster manufacturer should be consulted for this.

The plastering material and the associated accessories are services to be provided by the customer.

#### Detail: Fixing the wall grid

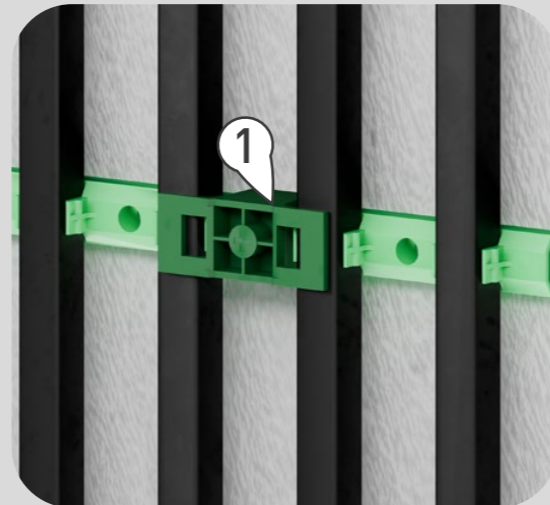

1. Fastening element with dowel (art. no. 4050000013)  
8 pieces per m<sup>2</sup> active area

#### Detail: Fixing the wall grid

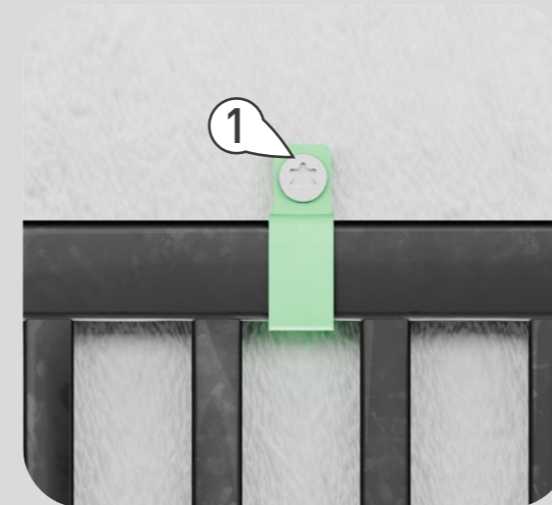

1. Bracket (art. no. 4090000001)

#### Detail: Connection pipework

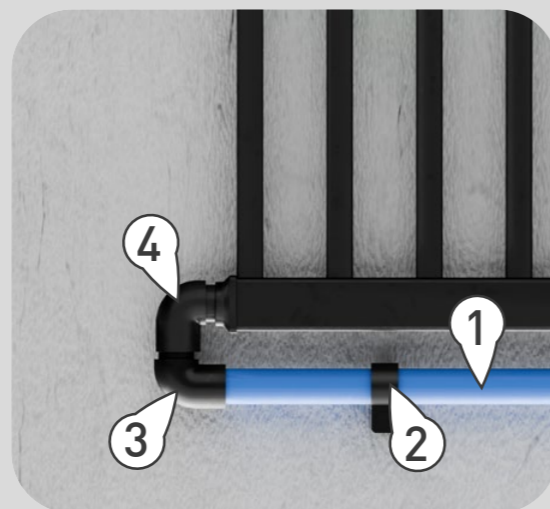

1. Connection pipework (art. no. 4110016003)
2. Plastic fastening clip (art. no. 4090016006)
3. Angle 90° inside/inside (art. no. 4080016000)
4. Angle 90° inside/outside (art. no. 4080016001)

#### Detail: Fixing the wall grid

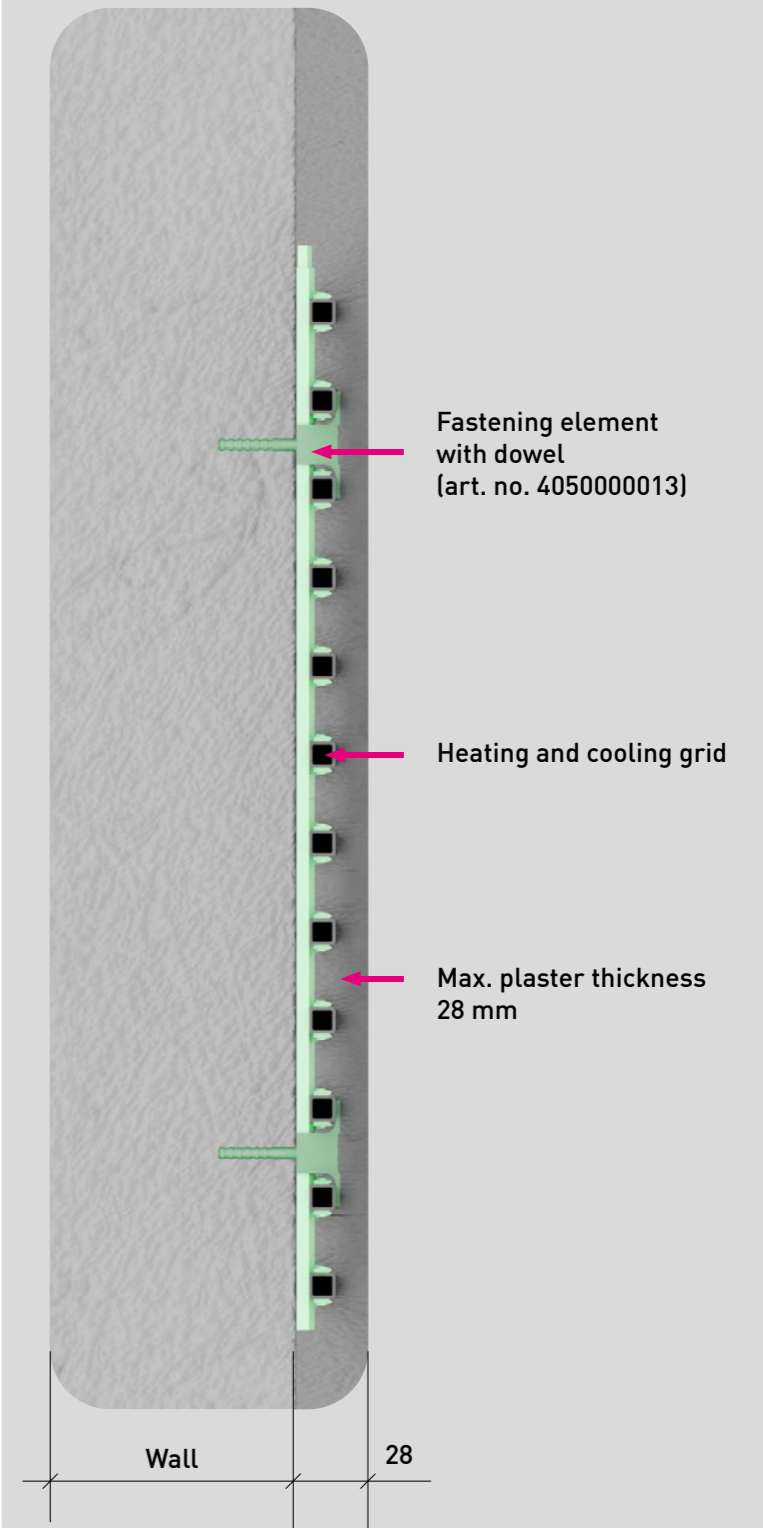





## Wall system: Plastered \_

### ASSEMBLY DESCRIPTION

#### Grid with welded connection Socket left, right (one-sided)

CONNECTION TYPE 45

#### Locating aquatherm grids in the ceiling, wall and floor

For the subsequent installation of pictures, mirrors etc., aquatherm offers a thermal film that can be used to visualise the aquatherm black system grids that are installed in ceilings, walls and floors and are therefore no longer visible. As an alternative to the thermographic camera, the coated film shows the temperature differences by discolouration.

1. The surface must have cooled down. The film is placed on the surface when it has cooled down.
2. The heating process can be started.
3. During the heating-up phase, the heating pipes of the grids slowly become visible through changes in colour. The duration depends on the overlap of the grids.

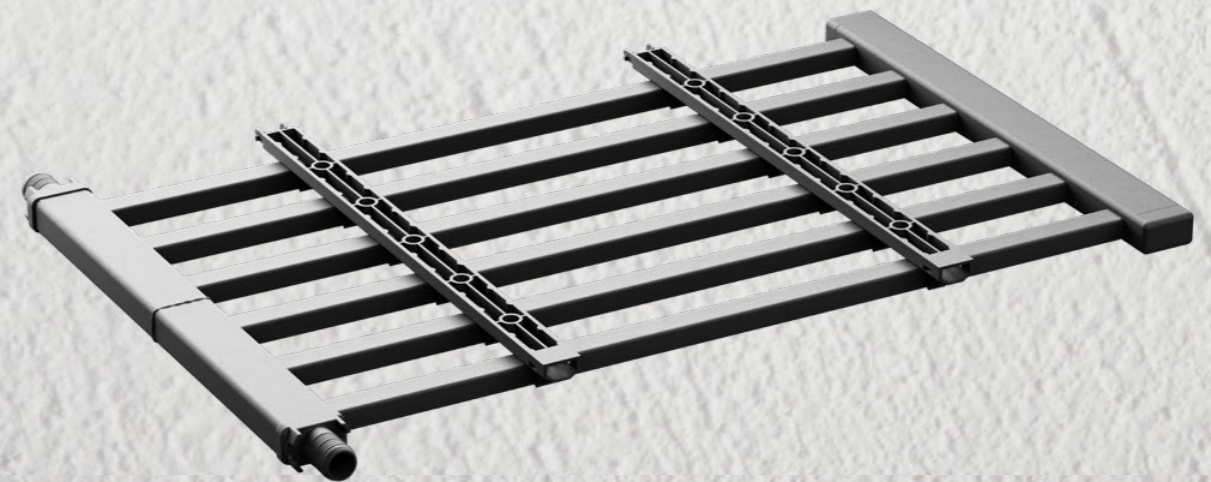
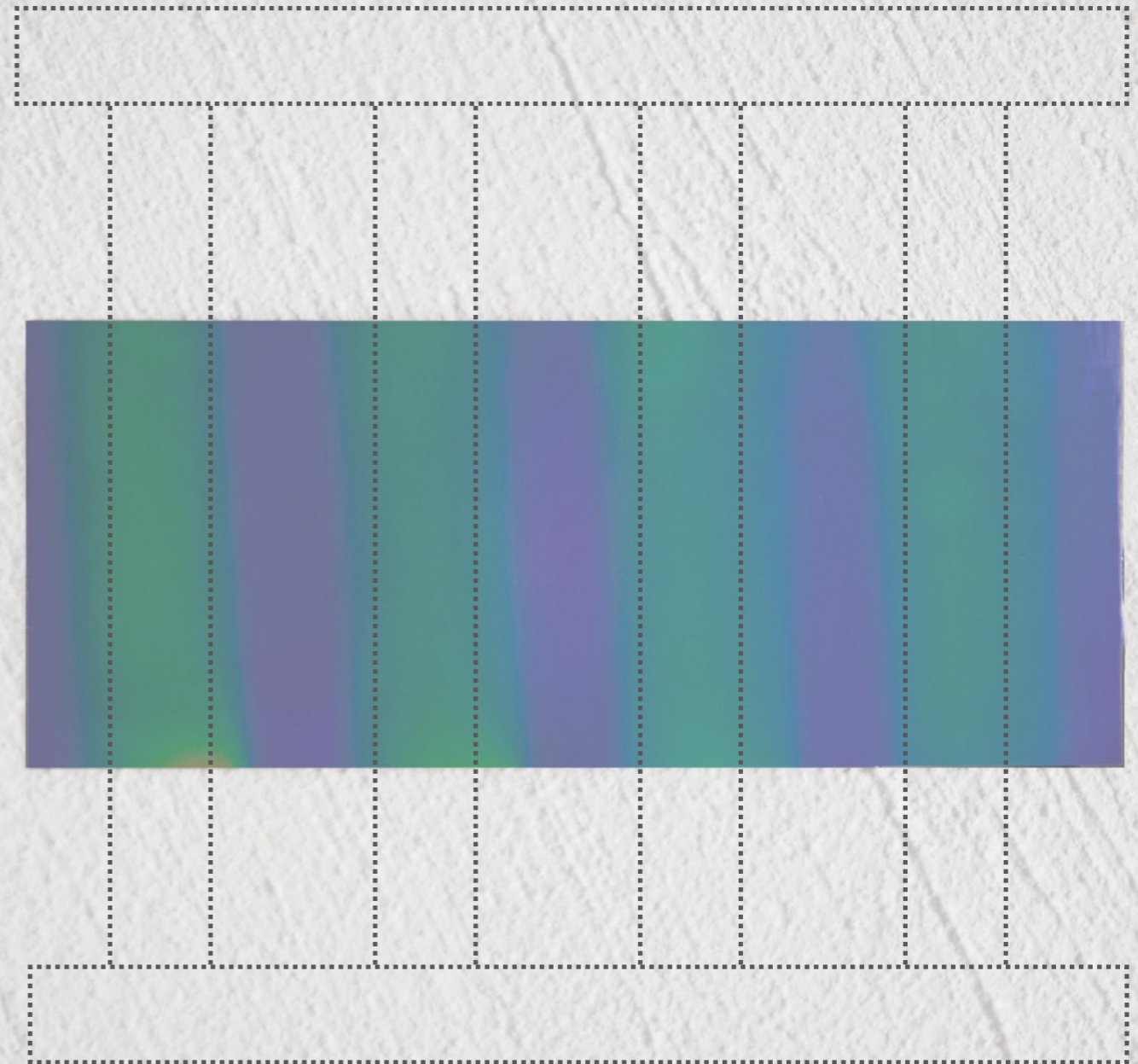





## Floor system: Screed \_\_

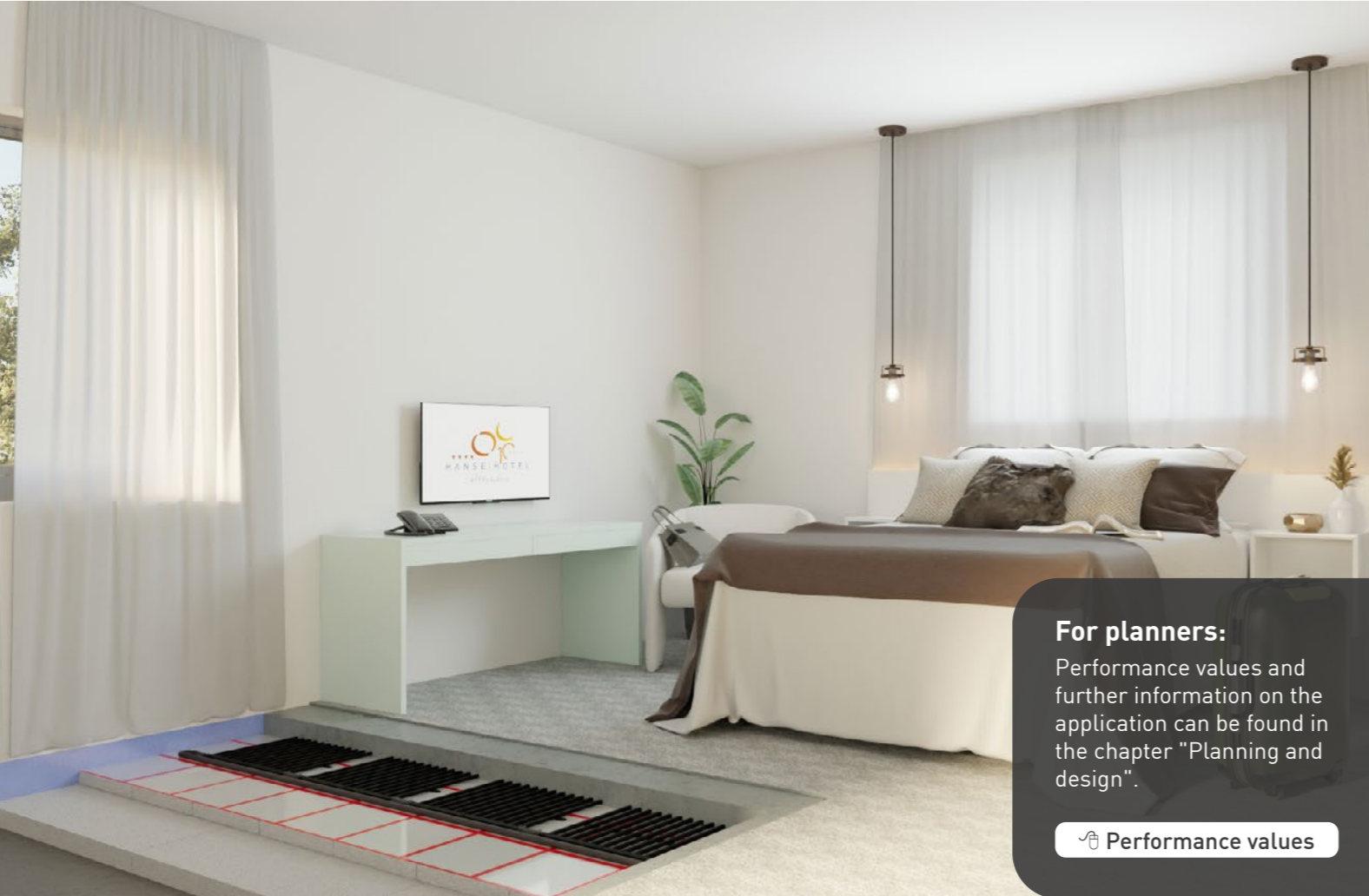

### For planners:

Performance values and further information on the application can be found in the chapter "Planning and design".

[Performance values](#)

### Advantages:

- Simple, safe and quicker installation.
- High efficiency thanks to low system temperatures.
- Pleasant indoor climate.
- No more visible radiators.
- Freedom in interior design.
- Can be combined with many floor coverings.
- Short heat-up and efficient reaction times.
- Silent, draught-free heating and cooling function.
- Efficient heating and cooling performance thanks to full-surface activation.
- Environmentally friendly thanks to the combination with regenerative low-temperature systems.



### System description

The aquatherm black heating and cooling grids can also be used as surface heating in the floor or screed.

The aquatherm black grids heat rooms with a high proportion of radiation. This not only ensures a greater sense of well-being, but also greater energy efficiency. Thanks to the large surfaces, it manages with very low heating medium temperatures compared to radiators.

The great freedom in interior design, without visible radiators, increases the value of the property in the long term.

aquatherm grids are increasingly being used in modernisation projects. Particularly where there are special requirements for the substrate and low installation heights.







## Floor system: Screed \_\_\_

Installation preconditions, requirements for the aquatherm heating and cooling grids

Before starting the installation work, check the conditions for installation on the construction site.

The following are the most important installation requirements for aquatherm surface heating and cooling systems in existing buildings:

Sufficient preconditions for perfect installation are:

Walls and ceilings must be plastered or plastered or prepared in such a way that no soiling can occur after the underfloor heating has been installed

Windows and external doors must be installed (the screed must be protected from draughts!)

In rooms that adjoin the ground, a moisture seal must be installed in accordance with DIN 18195. If no waterproofing is present, the site management must be notified in accordance with the VOB (German Construction Contract Procedures) so that the requirements for the start of installation can be clarified.

In the case of solvent-containing building waterproofing made of bituminous materials or other plasticiser-releasing substances, an intermediate or separating film must be laid before installing polystyrene thermal impact sound insulation. To prevent possible damage to the polystyrene insulation materials. In the case of PUR rigid foam boards, the intermediate foil can be omitted.

### Structure of the panel heating:

The correct structure is important for the panel heating in the floor to function properly (see sectional view).

This must be carried out in the screed in accordance with DIN 18560. The grid is embedded with overlap for this purpose.

### Load-bearing substrate:

The load-bearing substrate must not have any coarse unevenness, point-like elevations, different heights or insufficiently firm surfaces. The evenness tolerance must fulfil the requirements of DIN 18202.

### Insulating layer/materials:

When determining the insulation to be installed, the additional and specific heat loss for components with surface heating in accordance with DIN V 4108-6, Thermal insulation and energy saving in buildings, must be taken into account in addition to the resulting U-value.

In the insulation layer, the insulation boards must be laid tightly butted. Multi-layer insulation layers must be laid in such a way that the joints are offset against each other. A maximum of two layers may consist of impact sound insulation boards. The insulation layer must be in full contact with the underlay. Hollow areas must be eliminated by suitable measures.

According to DIN 18560, the compressibility of all insulation layers is limited to 5 mm up to 3 kN/m<sup>2</sup> and 3 mm up to 5 kN/m<sup>2</sup>, depending on the live loads. In the case of a combined application of impact sound and thermal insulation boards, the insulation material with the lower compressibility must be on top. This does not apply to impact sound insulating system boards and also not to cases of pipe levelling with thermal insulation boards.

Before the screed is applied, the insulation layer must be covered to protect it from moisture during the screed application and setting process.

Only standardised, approved and quality-assured insulation materials are permitted for the insulation. These must at least comply with building material class B2 in accordance with DIN 4102 for fire protection. New classifications according to DIN 4102 and DIN EN 13501: Building materials are classified with regard to their flammability and combustibility at national level according to DIN 4102 Fire behaviour of building materials and components and at European level according to DIN EN 13501 Classification of construction products and types of construction with regard to their fire behaviour.

Impact sound insulation in a building has a major influence on the quality of living. It is therefore necessary to plan and implement sound insulation measures.

The requirements for sound insulation are set out in DIN 4109.



## Floor system: Screed \_\_\_ Welding

### ASSEMBLY DESCRIPTION

#### Grid with welded connection Socket left, right (one-sided)

#### CONNECTION TYPE 45



### Effects of the DIN regulations

With the validity of EN 1264-4, the following innovations must be taken into account when installing hot water underfloor heating systems for residential, office and other buildings whose use corresponds to that of residential buildings:

The requirements of DIN 18560 and DIN EN 1264 must be observed. The bare concrete ceiling must be swept clean on site.

If pipes or electrical cables are laid on the load-bearing substrate, they must be fixed (to prevent them from floating).

A level surface must be created by levelling to accommodate the insulation layer, or at least the impact sound insulation.

- The grids and the connecting pipework must be laid at a distance of more than 50 mm from vertical components and 200 mm from chimneys, open flues, open or brick-built shafts and lift shafts.

- The maximum temperature in the vicinity of the heating elements in the screed is limited to 55 °C. For anhydrite screed, the maximum temperatures specified by the manufacturer apply.

- Before installing the screed, the heating circuits must be tested for leaks using a water pressure test. The test pressure must be twice the operating pressure - at least 6 bar - and must be maintained while the screed is being applied to the grids.

How much heat the heating surfaces give off depends on the flow temperature and, above all, the distance between the grids. In general, the closer the grids are to each other, the more heat is transferred to the room via the surface heating system.

### 1. Installation of the aquatherm black Heating and cooling grid

The grids are distributed on the insulation in the respective rooms according to the installation planning and fixed using fastening elements (aquatherm black pipe holders). Approx. 5 pipe brackets per m<sup>2</sup> are recommended to ensure sufficient fastening of the grids on the sub-insulation.

#### Note:

To avoid any thermal bridges or damage to the screed, the distance between the grids should not exceed 400 mm.

### 2. Connection of the aquatherm black Heating and cooling grids

When arranging the grids, the flow can be connected either on the left or right. The grids for installation in the screed are fitted with welding sockets (welding connection socket left, right). Once the grids have been installed in the floor, they are connected together to form heating or cooling zones in accordance with the installation plan.

### 3. Connection pipework of the aquatherm black heating and cooling grid to the distribution system

The heating or cooling circuits are connected to the manifold or the main pipework using aquatherm black 16 x 2 mm grid pipe. This can also be attached to the sub-insulation using pipe brackets.

The fixing distances of the pipe brackets for the connection pipework must be limited to 500 mm.

### 4. Floor covering

The screed is followed by the floor covering, which can be made of stone, ceramic, wood, plastic or carpet. Ceramic materials and stone tiles are particularly

favourable. This is because they conduct the heat from the grids into the room almost unhindered. If, on the other hand, customers opt for parquet, laminate or carpet flooring, this should be taken into account at the planning stage. The reason for this is the higher thermal resistance of the materials. A carpet, for example, has an insulating effect and the underfloor heating does not get really warm.

#### Note:

**Attention must be paid to the suitability of the floor coverings. The fitters can usually find out whether this is the case or not from the product description or a label on the packaging. If there is no information on the packaging, the respective manufacturer should be consulted.**

**The screed material and the associated accessories are to be provided by the customer.**





# Floor system: Screed Welding

## ASSEMBLY DESCRIPTION

Grid with welded connection  
Socket left, right (one-sided)

CONNECTION TYPE 45



Angle 90° inside / inside  
(art. no. 4080016000)

Angle 90° inside / outside  
(art. no. 4080016001)

PP connection pipe  
(art. no. 4110016003)

Heating and cooling grid

Max. grid width  
240-480 mm

Max. grid length  
600-2000 mm

Special dimensions on request

Tethering cable  
Flexible connection pipe  
(art. no. 4110016003)

Clamping device suitable for pipe holder  
(Art. no.: 9800096003)

Grid fastening  
(e.g. pipe holder art. no.: 5090000000)

Exterior/interior wall

Interior plaster

Structural waterproofing in accordance with DIN 18195 (as required)

Skirting board / edge trim

Edge insulation strips

Top coating

Screed  
Construction height according to DIN 18560  
Max. overlap grid 45mm

aquatherm black grid 14 x 2 mm

Rolling track system insulation (requirement according to GEG)

(Additional) insulation (requirement according to GEG)

Concrete slab

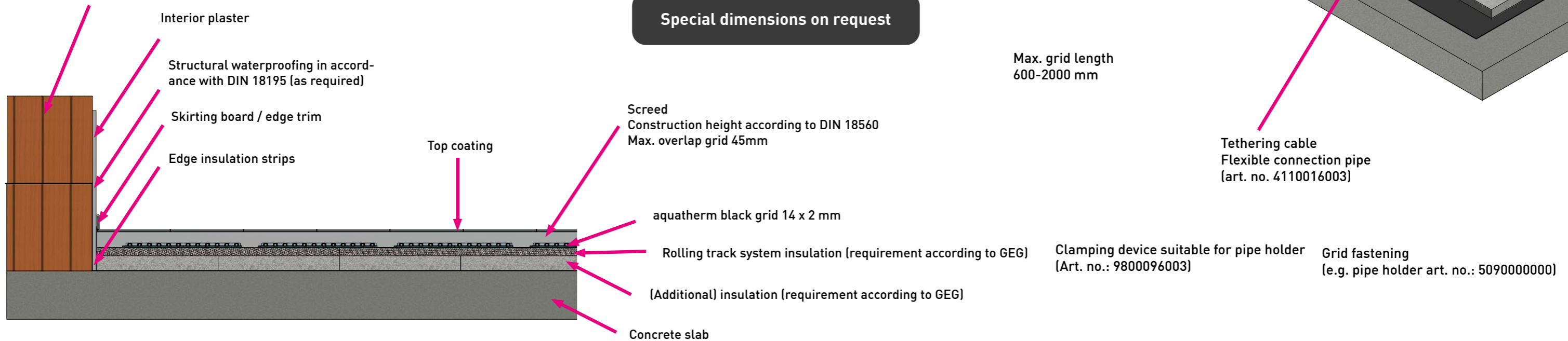

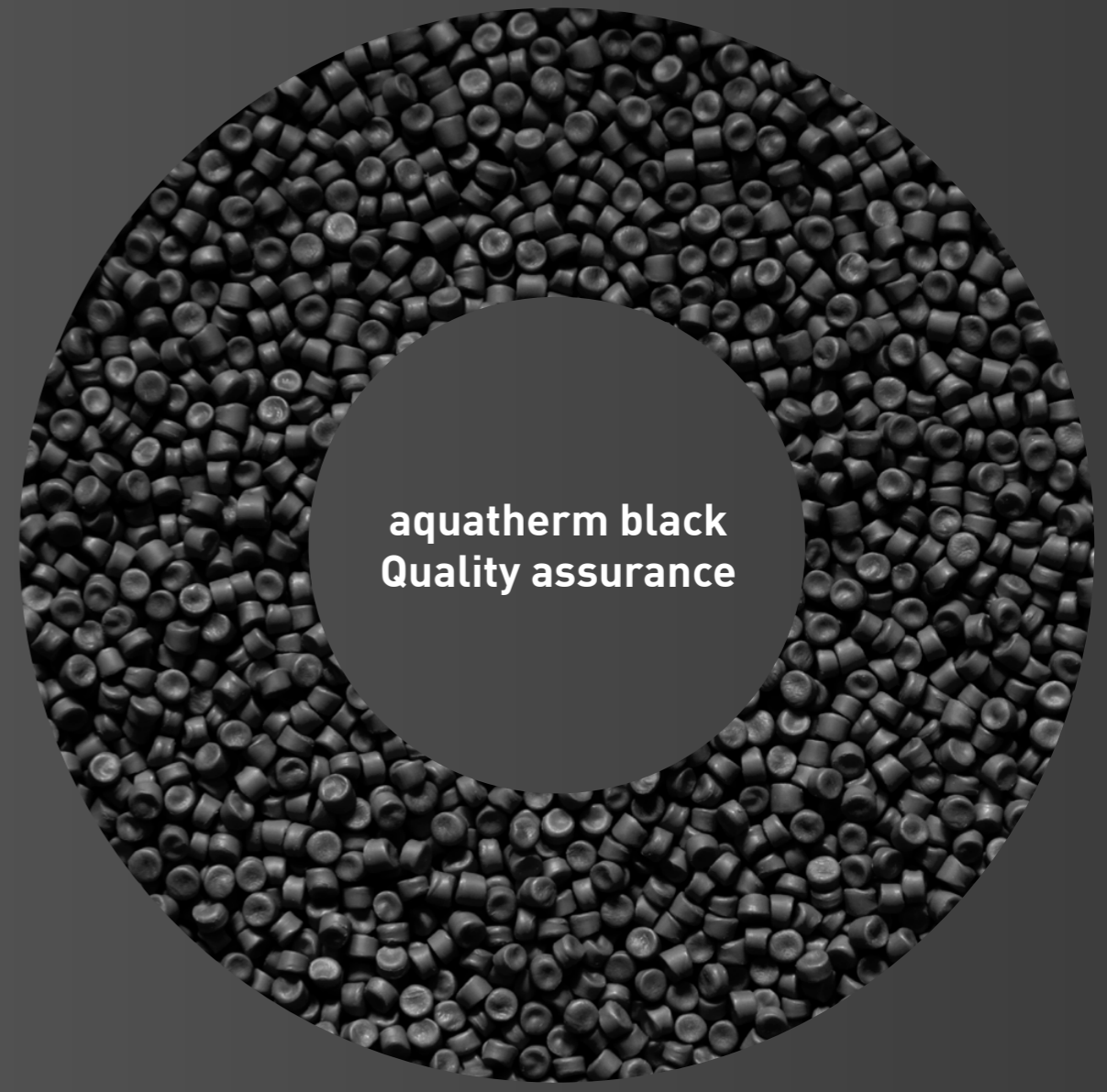
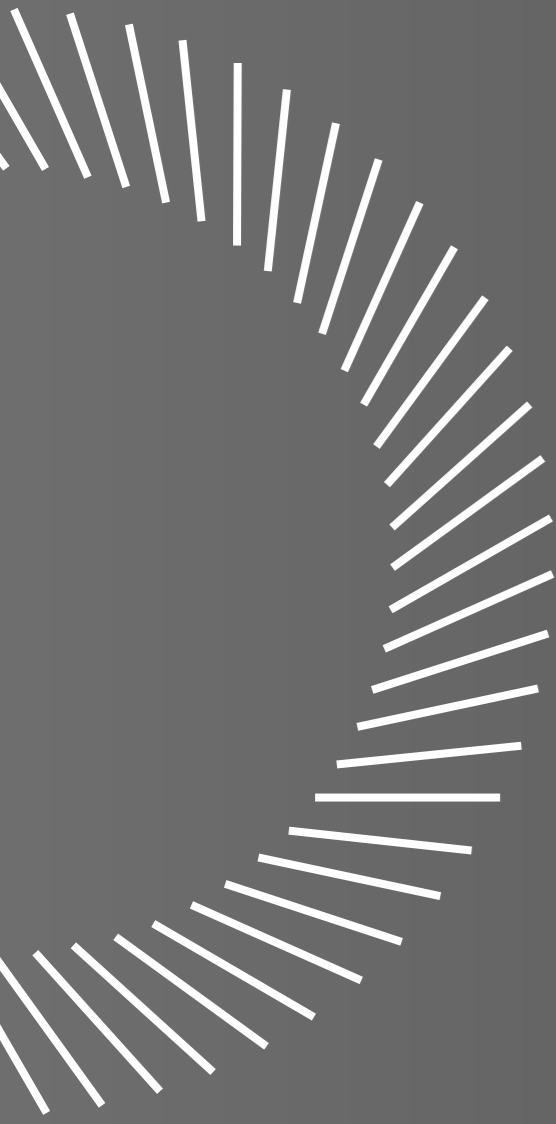

**aquatherm black**  
**Quality assurance**





## Quality „100 % Made in Germany“

Producing safe and innovative pipework systems - that is the promise that aquatherm lives by. This starts with the raw material: We develop and refine our polypropylene granulate under the fusiolen® brand. This enables us to always perfectly match the properties of our products to the requirements of the various areas of application.

Whether pipes or fittings: is "100% Made in Germany" for all of them. This is because we produce exclusively at our German sites in Attendorn (headquarters), Ennest and Radeberg using the latest manufacturing technology. Only tested products then start their journey to our customers worldwide. In addition to our permanent

in-house quality assurance, which includes monitoring test equipment, process, production and incoming goods inspections as well as final inspections, external monitoring is carried out by organisations such as the Süddeutsches Kunststoffzentrum (SKZ), NSF (National Sanitation Foundation, USA), IIP (Istituto Italiano di Plastici, Italy), CSTB (Centre Scientifique et Technique du Bâtiment, France), TGM (Technologisches Gewerbemuseum, Austria) and the Hygieneinstitut des Ruhrgebiets.

Numerous national and international quality seals and approval certificates as well as our satisfied customers repeatedly confirm the high quality standard of our products.

aquatherm has implemented a quality management system in accordance with ISO 9001, which was certified by TÜV-Rheinland in 1996. This success represents a further step towards strengthening our competitive position and fulfilling our high standards and responsibility towards customers, partners and the environment.

See for yourself!

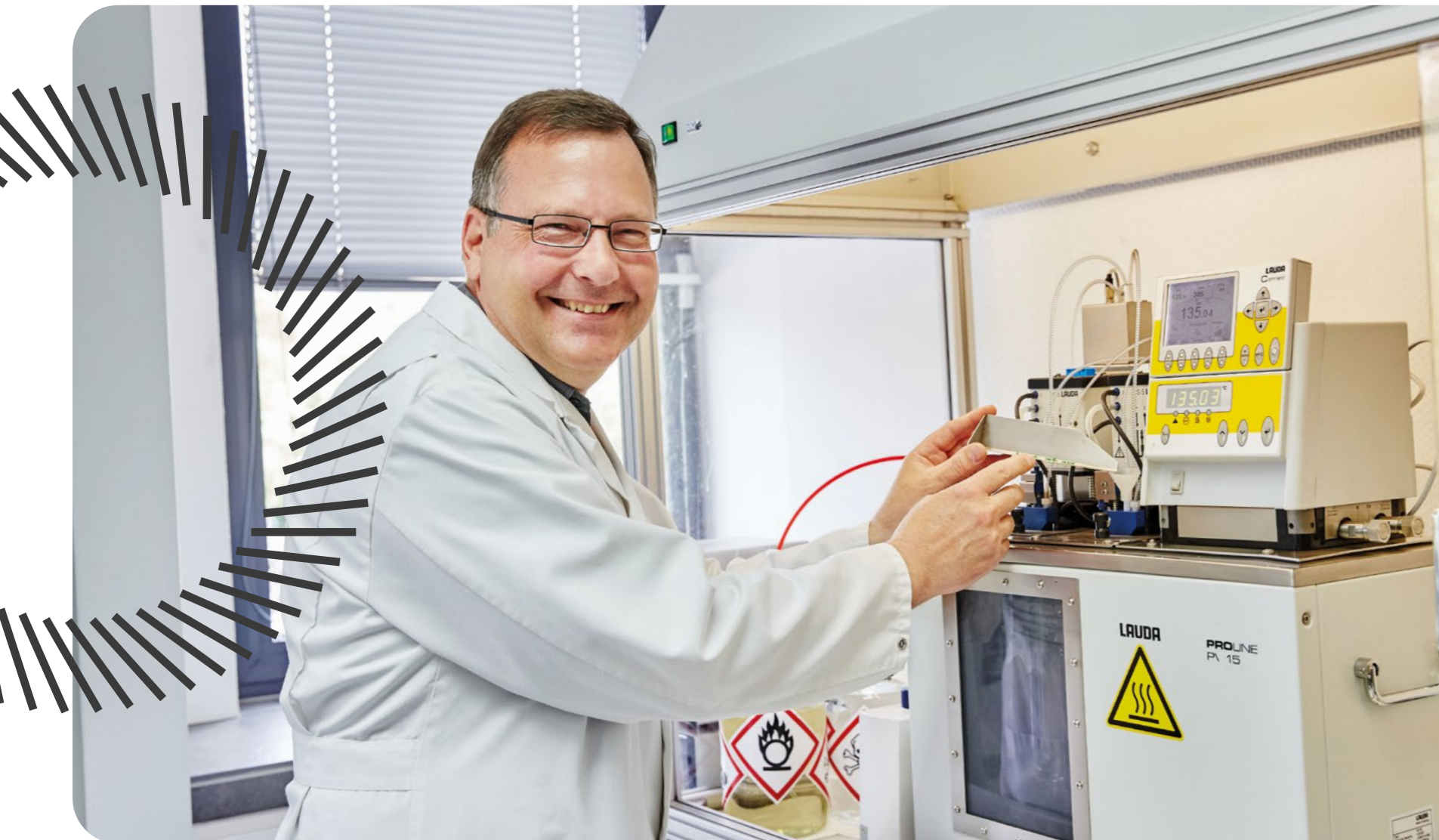

### Fulfilment of system standards

Numerous national and international neutral authorities and institutions confirm the high aquatherm quality standard.

The product certificates are provided for reference purposes only. The certificates were issued in accordance with the laws, regulations and product standards applicable in the respective country. The certificates therefore cannot be used outside the respective jurisdiction. They do not contain any express or implied warranties of aquatherm GmbH or its affiliates.

You can find an overview of our international certificates here:

[Certificate](#)

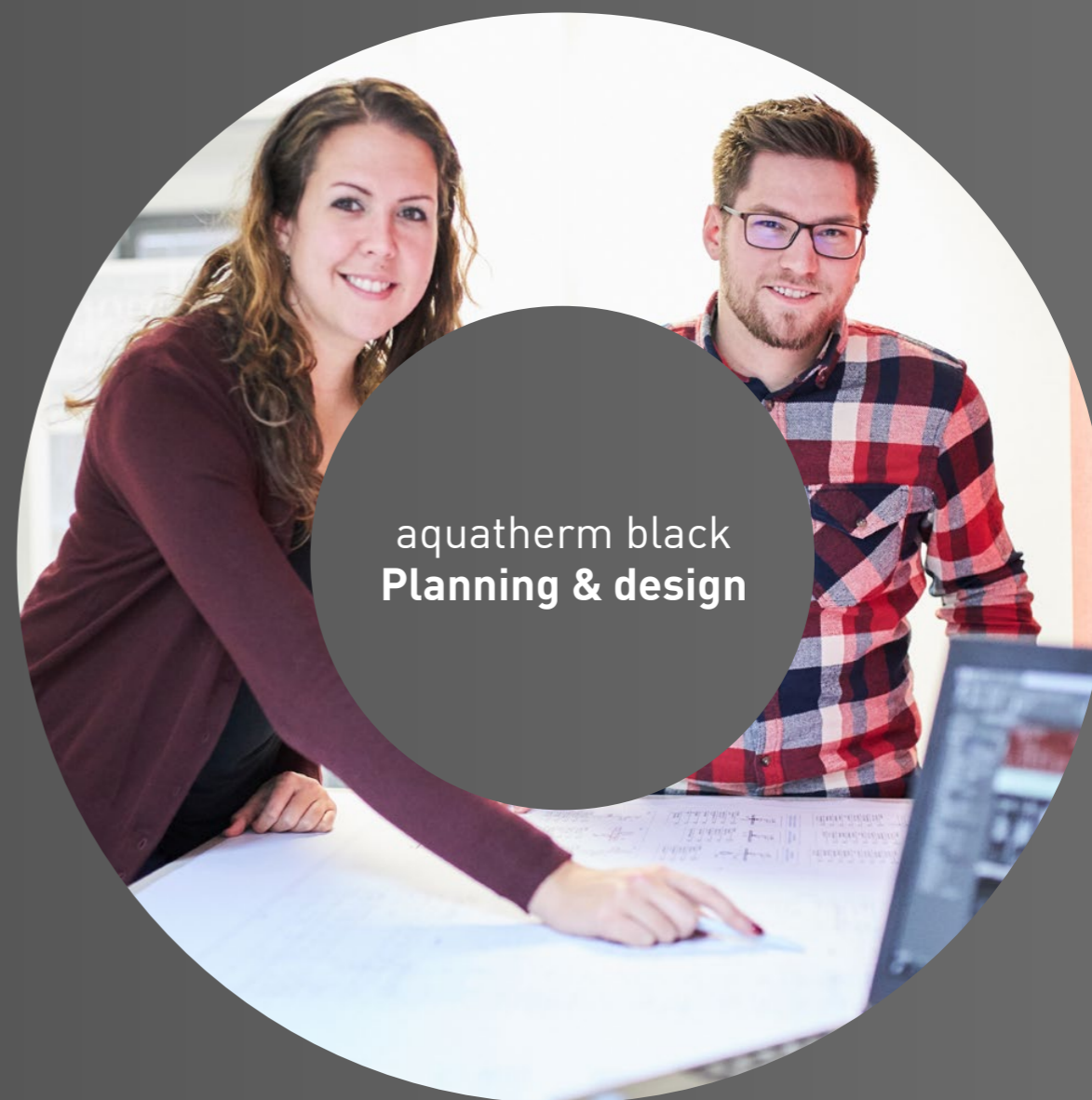

aquatherm black  
**Planning & design**

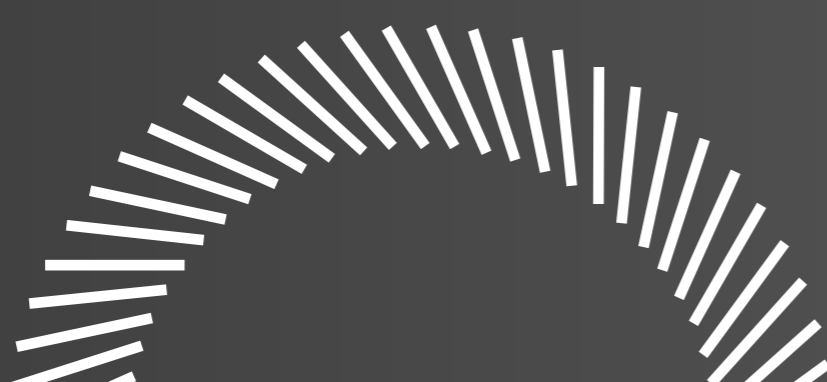





### Planning data

The digitalisation and legal regulations that countries around the world have introduced have ensured that the use and importance of Building Information Modelling (BIM) has increased. In our BIM portal, you will find all the relevant data that will make your work more efficient and provide you with optimum support in your planning projects. You can always find our latest tender texts on the online platform [www.ausschreiben.de](http://www.ausschreiben.de).

[ausschreiben.de](http://www.ausschreiben.de)

### Training courses

We offer processors, system builders and planners customised training courses on our entire product range. Visit us at the aquatherm Campus or online.



#### AQUATHERM PLANNING AND DESIGN

## Which **planning services** does aquatherm offer? \_\_

We have bundled our services under aquatherm services. Our competent staff will be happy to answer your questions about technical details and heating and control technology. They plan customised, holistic concepts and proposed solutions that are specifically tailored to your building project. aquatherm black has been extensively tested in a wide variety of installation forms. For performance data and technical details, please contact our aquatherm Services team.

### Advantages for architects and planners

- Planning support from aquatherm design team.
- Support with plausibility and completeness checks.
- System design based on verified performance data.
- Provision of CAD and planning data.
- Early detailed planning leads to planning and cost certainty.
- Time savings through prefabrication.
- Many years of experience in planning and system design.

### Advantages for installers

- High, tested quality with a 10-year guarantee.
- Maximum accuracy thanks to detailed pre-planning.
- Order support and delivery by specialised wholesalers.
- No delays due to missing parts.
- Low tool costs.
- Information and training programme.
- Weight saving through the use of PP-R, as is easier to handle during transport and on the construction site.
- No improvisation on the construction site.
- Faster assembly times, therefore less labour required.
- Installation possible in confined spaces.

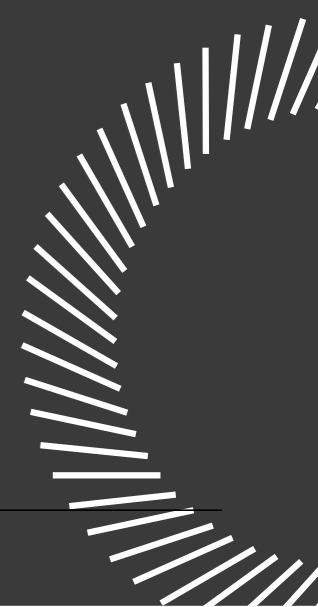



## Control concept

Discover our complete package for optimised control of your surface heating or cooling, right through to the heating/cooling circuit manifold interface. New and old buildings, small or large projects, we have the right solution for every requirement, including integration into existing systems.

For surface heating and cooling systems, individual room control is mandatory in accordance with legal requirements, provided that the rooms are tempered via this system. Individual room control can only be dispensed with for the base load, while peak loads are covered by a separate cooling/heating system with individual room control.

The room temperature is controlled effortlessly using a wall-mounted room thermostat. It is important to choose the position of the room thermostat carefully so that it is not affected by curtains, draughts or direct sunlight. In cooling mode, the room thermostat controls an actuator that opens or closes a control valve when the temperature falls below the set temperature and in heating mode when the temperature exceeds the set temperature.

For systems that both heat and cool, the switchover signal between heating and cooling mode is issued by an automatic management module with a potential-free switching output.

Aquatherm offers various options to prevent condensation forming on cooled surfaces in ceilings or walls.

### **Interruption of the volume flow:**

We provide you with protection against condensation. An NTC temperature sensor is used at critical points, such as the cold water supply. This works together with our digitally programmable wireless room thermostat, which is also equipped with hygrometers (humidity sensors). Together, they continuously monitor the temperature and humidity behaviour between the cooling level and the room. As soon as a critical thermal range becomes apparent, they intervene immediately - the cooling function is stopped and the cooling zone is closed.

### **Adjusting the flow temperature (external control):**

Our intelligent solution makes it possible to regulate the flow temperature of the cooling ceiling depending on the dew point temperature of reference rooms.

A humidity and temperature sensor continuously calculates the dew point and ensures that the flow temperature is permanently kept 0.5 K to 1.0 K above the critical temperature. This reliably prevents condensation from forming in the room. By monitoring the supply of humid air using open windows and window contacts, we ensure that the control functions optimally, even when fresh air flows into the room. Please note that the dew point sensor should only be installed on plastic pipes.







## Planning and design "Heating and cooling" ---

### Calculation

Before designing the aquatherm black surface heating and cooling system, a heating load calculation in accordance with DIN EN 12831 or a cooling load calculation in accordance with VDI 2078 must generally be carried out.

$$Q_{\text{Aust}} = \frac{Q_{\text{H}}}{A_{\text{f}}}$$

$Q_{\text{Aust}}$  = Design heat flux density  
 $Q_{\text{H}}$  = Thermal output in accordance with DIN EN 12831 minus the transmission heat losses through the components covered with the wall heating system  
 $A_{\text{f}}$  = Wall surface equipped with wall heating

### Crediting of performance charts

The following performance diagrams must be taken into account for aquatherm black wall and ceiling heating in wet and dry construction and for the aquatherm black dry construction heating element.

The diagrams apply to the Wet construction system with wall plaster with the thermal conductivity and plaster cover from top edge of heating pipe = 10 mm

$\lambda = 0.35 \text{ W/mK}$	Gypsum plaster without aggregate
$\lambda = 0.70 \text{ W/mK}$	Lime gypsum plaster
$\lambda = 0.87 \text{ W/mK}$	Lime cement plaster, lime plaster

#### Drywall systems (with plasterboard)

$\lambda = 0.21 \text{ W/mK}$	Plasterboard
$\lambda = 0.30 \text{ W/mK}$	Thermoboard Firma Knauf
$\lambda = 0.52 \text{ W/mK}$	Thermoboard Plus Company Knauf
$\lambda = 0.52 \text{ W/mK}$	climafit Company Rigips

#### Drywall systems (with metal cassette ceiling)

$\lambda = 46.5 \text{ W/mK}$	Sheet steel
$\lambda = 200 - 230 \text{ W/mK}$	Aluminium

## Standards and guidelines ---

### Standards and guidelines

The following standards and guidelines must be observed when planning and designing the aquatherm black:

GEG	Building Energy Act
VDI 2073-2 VDI 2078 VDI 6031 VDI 6034	Hydraulics in technical building equipment systems Calculation of thermal loads and room temperatures Acceptance test of room cooling surfaces Cooling surface planning, construction and operation
DIN EN 998 DIN EN 1264 DIN EN ISO 7730	Plaster mortar Surface-integrated heating and cooling systems with water flow Moderate ambient climate Determination of PMV and PPD and description of thermal comfort conditions (ISO 7730:1994)
DIN EN 12831 DIN EN 12828	Heating systems in buildings - Method for calculating the standardised heating load Heating systems in buildings. Design and installation of hot water heating systems. Annex B (informative) Thermal comfort
DIN EN 13297	Gypsum binder and dry gypsum mortar
DIN EN 14037	Heating and cooling surfaces for water freely suspended from the ceiling
DIN EN 14240 DIN EN 14336	Ventilation for buildings - Chilled ceilings - Testing and evaluation Heating systems in buildings - Installation and acceptance of hot water heating systems
DIN EN 15251	Input parameters for the indoor climate for the design and evaluation of Energy efficiency of buildings - Indoor air quality, temperature, light and acoustics
DIN EN 16798-3	Ventilation of non-residential buildings Performance requirements for ventilation and air conditioning and room cooling systems
DIN 1946-6 DIN 4102 DIN 4108 DIN 4109 DIN 4726	Creation of a ventilation concept Fire protection in building construction Thermal insulation in building construction Sound insulation in building construction Hot water panel heating systems, plastic pipe and composite pipework systems
DIN 18180 DIN 18181 DIN 18182 DIN 18195 DIN 18202 DIN 18350 DIN 18380 DIN 18550	Plasterboard Gypsum plasterboard in building construction Accessories for processing plasterboard Waterproofing of buildings Dimensional tolerances in building construction Plastering and stucco work Heating systems and central water heating systems Interior plaster
DIN 18942-1 DIN 18942-100 DIN 18945 DIN 18946 DIN 18947 DIN 18948	Earthen building materials, Part 1: Definitions Earthen building materials, Part 100: Proof of conformity Clay blocks, requirements and test methods Earthen masonry mortar, requirements and test methods Clay plaster mortar >3mm, requirements and test methods Clayboards, requirements and test methods

(Separate processing guidelines of the respective manufacturers)



## Planning and design "Heating and cooling" ---

### Design of an aquatherm black ceiling cooling system

Standard cooling capacities measured in accordance with DIN EN 14240: 2004-04 are available for the aquatherm black ceiling cooling system for the standard installation situation.

As the standard cooling capacity has been measured under test bench conditions, it must be adjusted under specific (real) conditions. These include the spatial conditions (the height of the room), the influence of the external facade with high surface temperatures, the influence of ventilation on the convective heat transfer of the cooling ceiling and the rear ventilation of the cooling ceiling through an open shadow gap.

**The influence of these parameters can increase the actual cooling capacity of an aquatherm black cooling ceiling by 6-10% compared to the standard cooling capacity.**

#### Design example of an aquatherm black ceiling heating system

Room	Office, GK Knauf Thermoboard plus - without insulation
Room temperature	20° C
Heating load	1000 Watt
Flow temperature	40° C
Return temperature	35° C
Linear temperature difference	17,5 K
Spread $\Delta T$	5 K
Grid width	320 x 2000 mm
Heating capacity per m <sup>2</sup> grid	114 W/m <sup>2</sup>
Required occupied area	1000 W / 114 W/m <sup>2</sup> = 8,8 m <sup>2</sup>
Selected grid	320 x 2000 mm = 0.64 m <sup>2</sup>
Number of grids	8.8 m <sup>2</sup> / 0.64 m <sup>2</sup> = 13.75 Stck → 14 Stck
Total area grid	14 x 0.64 m <sup>2</sup> = 8.96 m <sup>2</sup>
Total heating capacity	8.96 m <sup>2</sup> x 114 W/m <sup>2</sup> = 1021 W
Total volume flow	$m = Q / c \times \Delta T$ m = 1021 Watt / 1,163 Wh/kg*K x 5 K = 176 kg/h (l/h)

#### Design example of an aquatherm black ceiling cooling system

Room	Office, with metal ceiling in strip grid system - with insulation
Room temperature	26° C
Cooling load	1500 watts
Flow temperature	15° C
Return temperature	17° C
Linear temperature difference	10 K
Spread $\Delta T$	2 K
Grid width	560 x 1180 mm
Cooling capacity per m <sup>2</sup> grid	90 W/m <sup>2</sup>
Required occupied area	1500 W / 90 W/m <sup>2</sup> = 16,7 m <sup>2</sup>
Selected grid	560 x 1180mm = 0.66 m <sup>2</sup>
Number of grids	16.7 m <sup>2</sup> / 0.66 m <sup>2</sup> = 25.3 Stck → 26 Stck
Total area grid	26 x 0,66 m <sup>2</sup> = 17,16 m <sup>2</sup>
Total cooling capacity	17.16 m <sup>2</sup> x 90 W/m <sup>2</sup> = 1544 W
Total volume flow	$m = Q / c \times \Delta T$ m = 1544 Watt / 1.163 Wh/kg*K x 2 K = 664 kg/h (l/h)





## Planning and design "Heating and cooling" \_\_\_

## Design data \_\_\_

### Mass flow of the aquatherm black grid

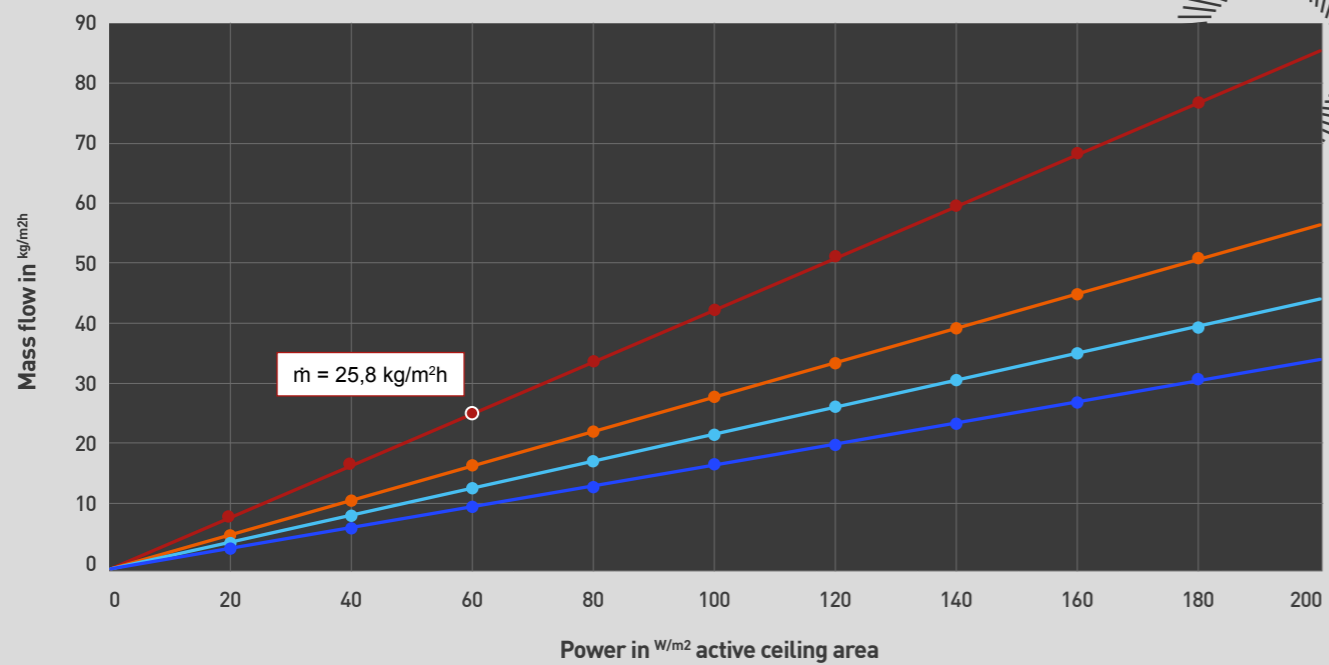

#### Legend:

- Temperature difference VL/RL 2K
- Temperature difference VL/RL 3K
- Temperature difference VL/RL 4K
- Temperature difference VL/RL 5K

The mass flow is required for the design of the heating and cooling surfaces, for the pipe network calculation and the hydraulic balancing of the system.

The mass flow of the heating medium is calculated based on the calculated heating load (DIN EN 12831) of the respective room or heating surface. The temperature difference between the flow and return must be determined before the calculation. The mass flow transports the required energy to the respective heating surface.

#### Determination of the mass flow for the grid area per m²:

Example:

Power activated area per m²:  $Q_{\text{spec.}} = 60 \text{ W/m}^2$

Active zone with grids:  $A_{\text{active zone}} = 6.20 \text{ m}^2$

Spreading:  $\Delta\theta = 2\text{K}$

Performance of the active zone:  
 $Q_{\text{active zone}} = A_{\text{active zone}} * Q_{\text{spec.}}$   
 $Q_{\text{active zone}} = 6.20\text{m}^2 * 60 \text{ W/m}^2$   
 $Q_{\text{active zone}} = 372 \text{ W}$

Mass flow of the active zone:  
 $\dot{m}_{\text{active zone}} = Q_{\text{active zone}} / c * \Delta\theta$   
 $\dot{m}_{\text{Active zone}} = 372\text{W} / 1.163 \text{ Wh/kg} * \text{K} * 2\text{K}$   
 $\dot{m}_{\text{Active zone}} = 25.80 \text{ kg/m}^2\text{h}$

Specific mass flow per m²  
 $\dot{m}_{\text{spec.}} = \dot{m}_{\text{active zone}} / A_{\text{active area}}$   
 $\dot{m}_{\text{spez.}} = 159.90 \text{ kg/h} / 6.20 \text{ m}^2$   
 $\dot{m}_{\text{spez.}} = 25,80 \text{ kg/m}^2\text{h}$

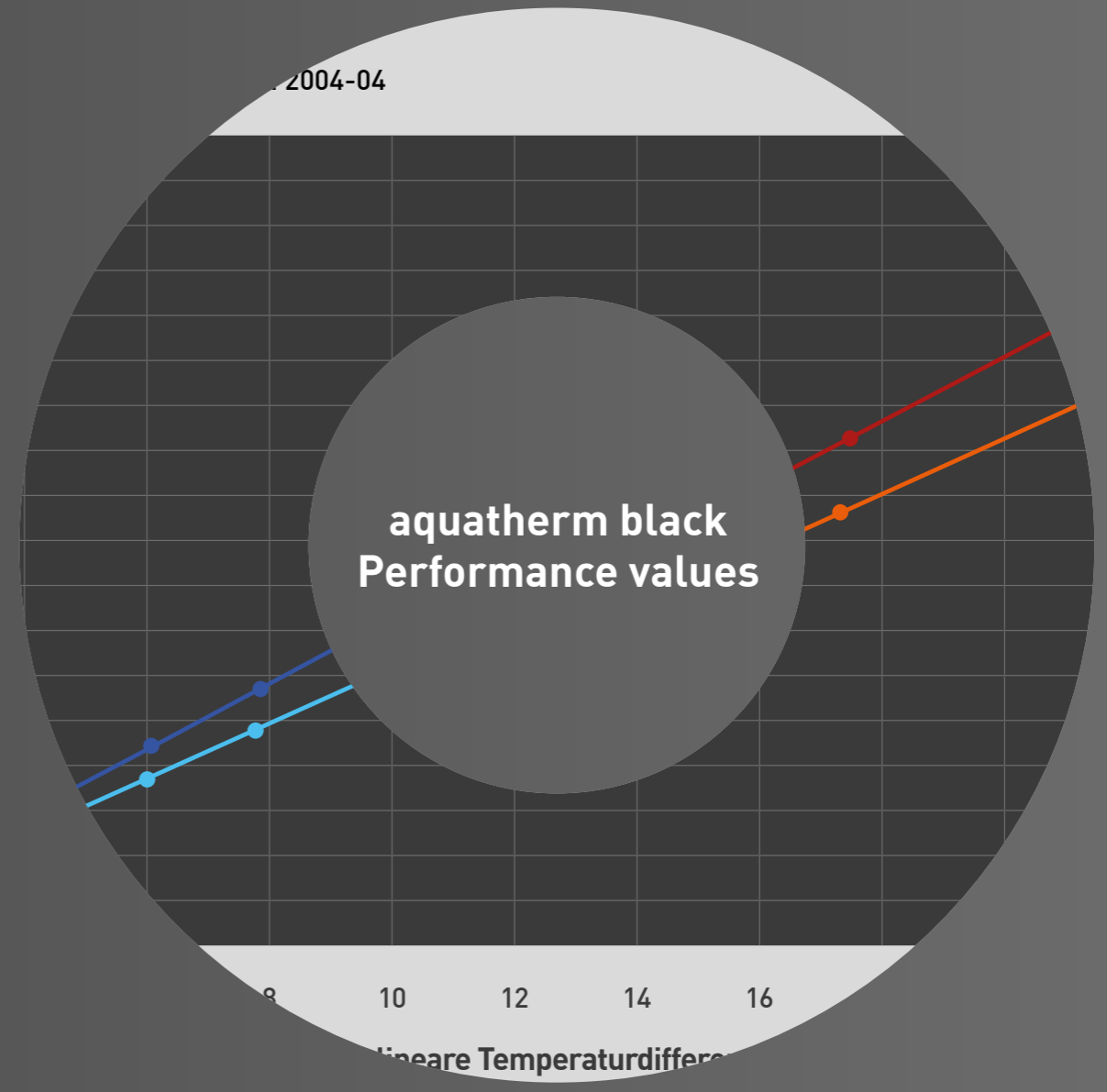





## aquatherm black performance values

### aquatherm black performance values: Insert system drywall ceiling

Standard heating output according to DIN EN 14037-2  
Standard cooling capacity according to DIN EN 14240: 2004-04

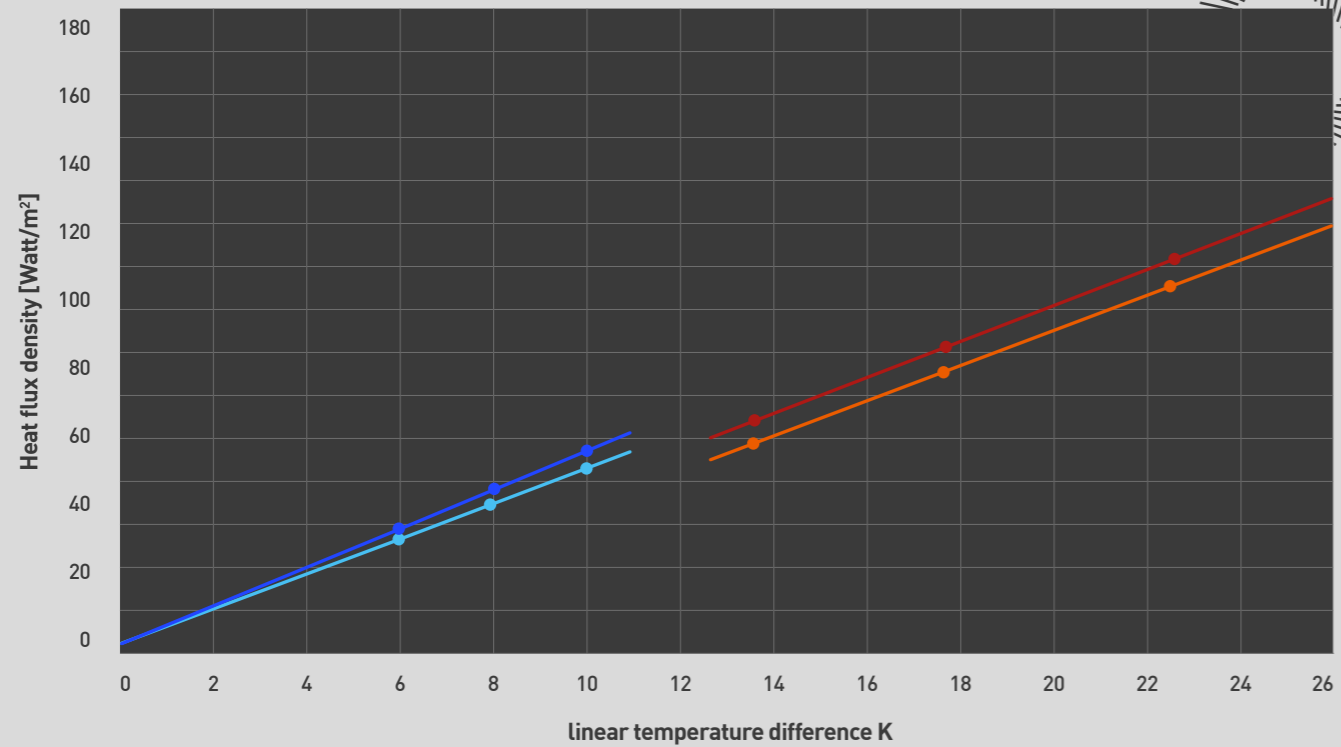

Cooling capacity calculation example for: Flow temperature 15°C / return temperature 17°C

linear temperature difference K	6	8	10
Room temperature °C	22	24	26
Plasterboard - standard, with insulation (12.5 mm) W/m²	30	40	51
Plasterboard - standard, without insulation (12.5 mm) W/m²	32	44	55

Calculation example for: flow temperature 40°C / return temperature 35°C

linear temperature difference K	13,5	17,5	22,5
Room temperature °C	24	20	15
Plasterboard - standard, with insulation (12.5 mm) W/m²	61	80	106
Plasterboard - standard, without insulation (12.5 mm) W/m²	65	86	113

### aquatherm black performance values: Drywall ceiling - plasterboard

Standard heating output according to DIN EN 14037-2  
Standard cooling capacity according to DIN EN 14240: 2004-04

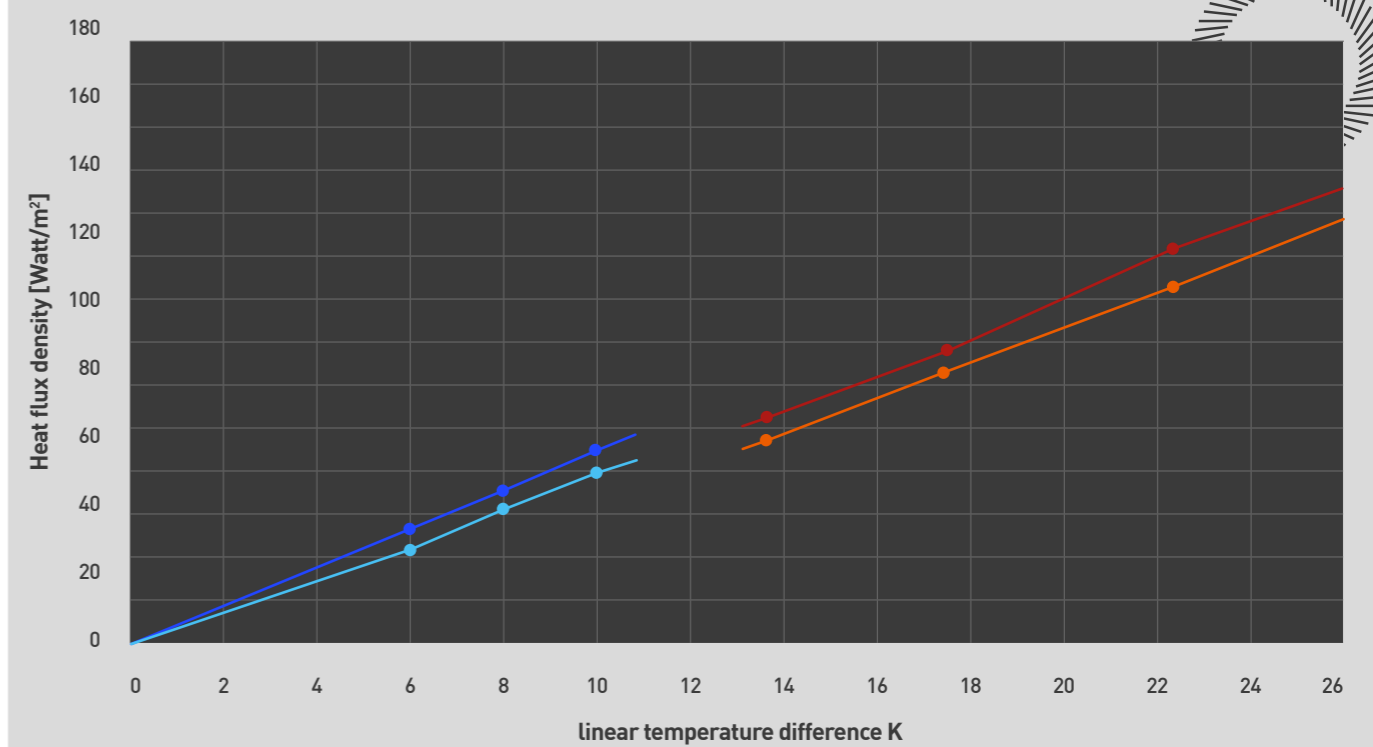

Cooling capacity Calculation example for: Flow temperature 15°C / return temperature 17°C

linear temperature difference K	6	8	10
Room temperature °C	22	24	26
Plasterboard - standard, with insulation (12.5 mm) W/m²	30	40	51
Plasterboard - standard, without insulation (12.5 mm) W/m²	32	44	55

Calculation example for: flow temperature 40°C / return temperature 35°C

linear temperature difference K	13,5	17,5	22,5
Room temperature °C	24	20	15
Plasterboard - standard, with insulation (12.5 mm) W/m²	61	80	106
Plasterboard - standard, without insulation (12.5 mm) W/m²	65	86	113

Test certificates required?  
Please contact [service@aquatherm.de](mailto:service@aquatherm.de)



## aquatherm black performance values: Plaster ceiling

Standard heating output according to DIN EN 14037-2  
Standard cooling capacity according to DIN EN 14240: 2004-04

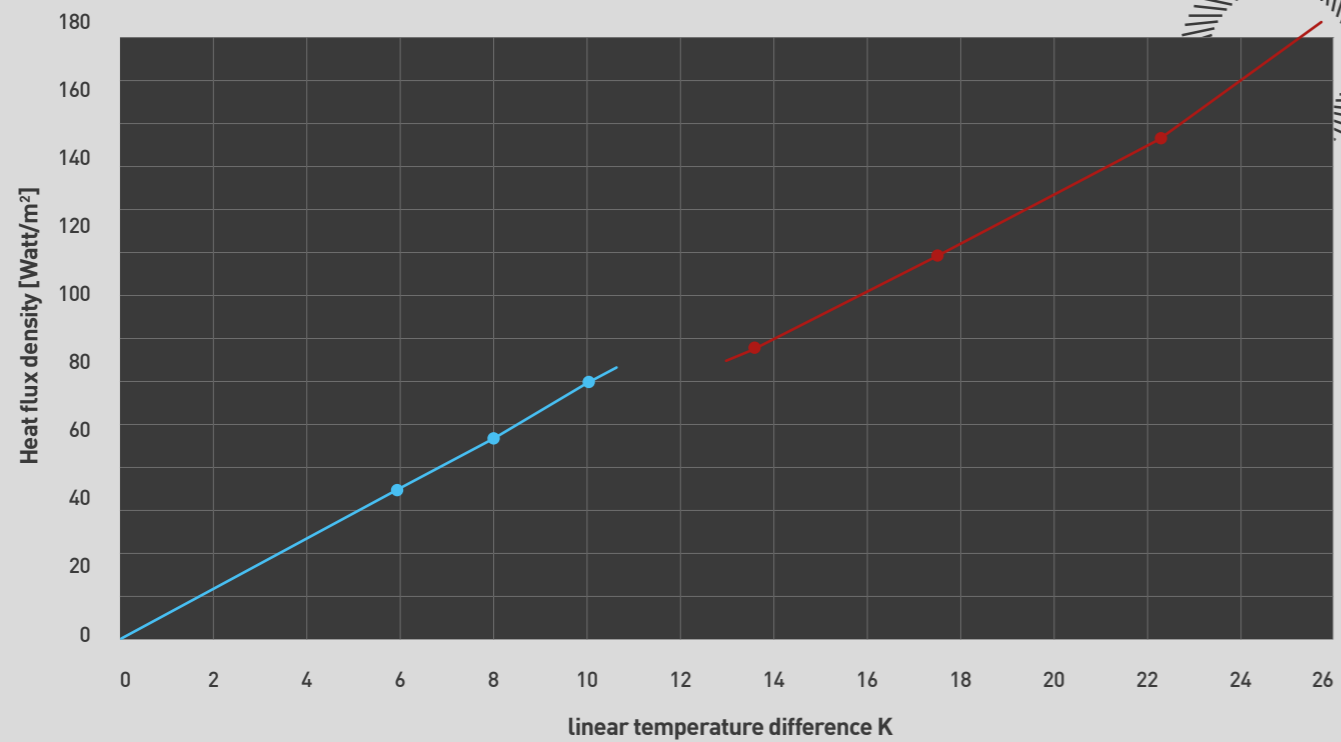

Cooling capacity calculation example for: Flow temperature 15°C / return temperature 17°C

linear temperature difference K	6	8	10
Room temperature °C	22	24	26
Plaster ceiling W/m²	43	59	75

Calculation example for: flow temperature 40°C / return temperature 35°C

linear temperature difference K	13,5	17,5	22,5
Room temperature °C	24	20	15
Plaster ceiling W/m²	84	111	146

## aquatherm black performance values: Sails - thermally activated

Standard heating output according to DIN EN 14037-2  
Standard cooling capacity according to DIN EN 14240: 2004-04

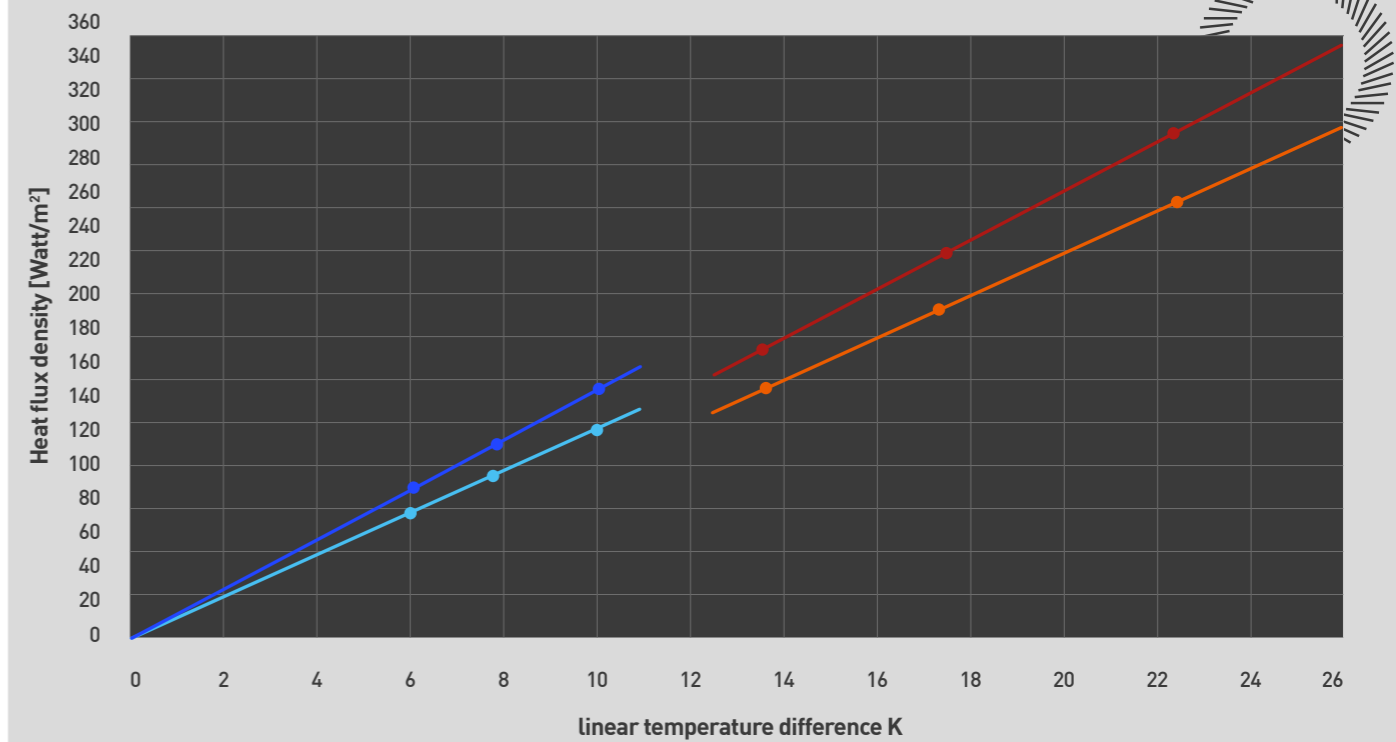

Cooling capacity calculation example for: Flow temperature 15°C / return temperature 17°C

linear temperature difference K	6	8	10
Room temperature °C	22	24	26
Metal ceiling sails with acoustic fleece, with insulation W/m²	71	97	122
Metal ceiling sails with acoustic fleece, without insulation W/m²	85	115	146

Calculation example for: flow temperature 40°C / return temperature 35°C

linear temperature difference K	13,5	17,5	22,5
Room temperature °C	24	20	15
Metal ceiling sails with acoustic fleece, with insulation W/m²	147	195	256
Metal ceiling sails with acoustic fleece, without insulation W/m²	168	224	296

Test certificates required?  
Please contact [service@aquatherm.de](mailto:service@aquatherm.de)





### aquatherm black performance values: Metal cassette ceiling - clamping/hanging system

Standard heating output according to DIN EN 14037-2  
Standard cooling capacity according to DIN EN 14240: 2004-04

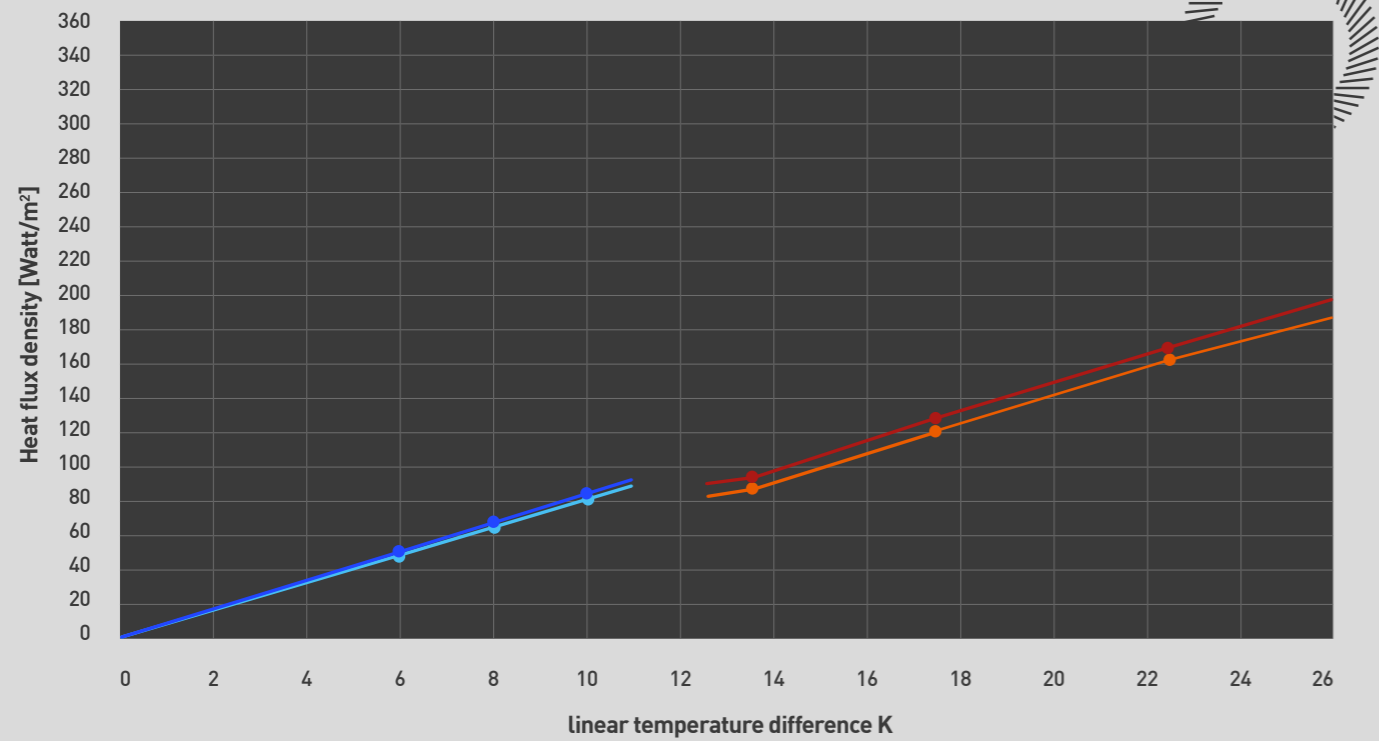

Cooling capacity calculation example for: Flow temperature 15°C / return temperature 17°C

linear temperature difference K	6	8	10
Room temperature °C	22	24	26
Metal ceiling - clamping system with acoustic fleece, with insulation W/m <sup>2</sup>	49	66	83
Metal ceiling - clamping system with acoustic fleece, without insulation W/m <sup>2</sup>	50	67	85

Calculation example for: Flow temperature 40°C / return temperature 35°C

linear temperature difference K	13,5	17,5	22,5
Room temperature °C	24	20	15
Metal ceiling - clamping system with acoustic fleece, with insulation W/m <sup>2</sup>	91	121	160
Metal ceiling - clamping system with acoustic fleece, without insulation W/m <sup>2</sup>	94	125	165

### aquatherm black performance values: Metal cassette ceiling - strip grid system

Standard heating output according to DIN EN 14037-2  
Standard cooling capacity according to DIN EN 14240: 2004-04

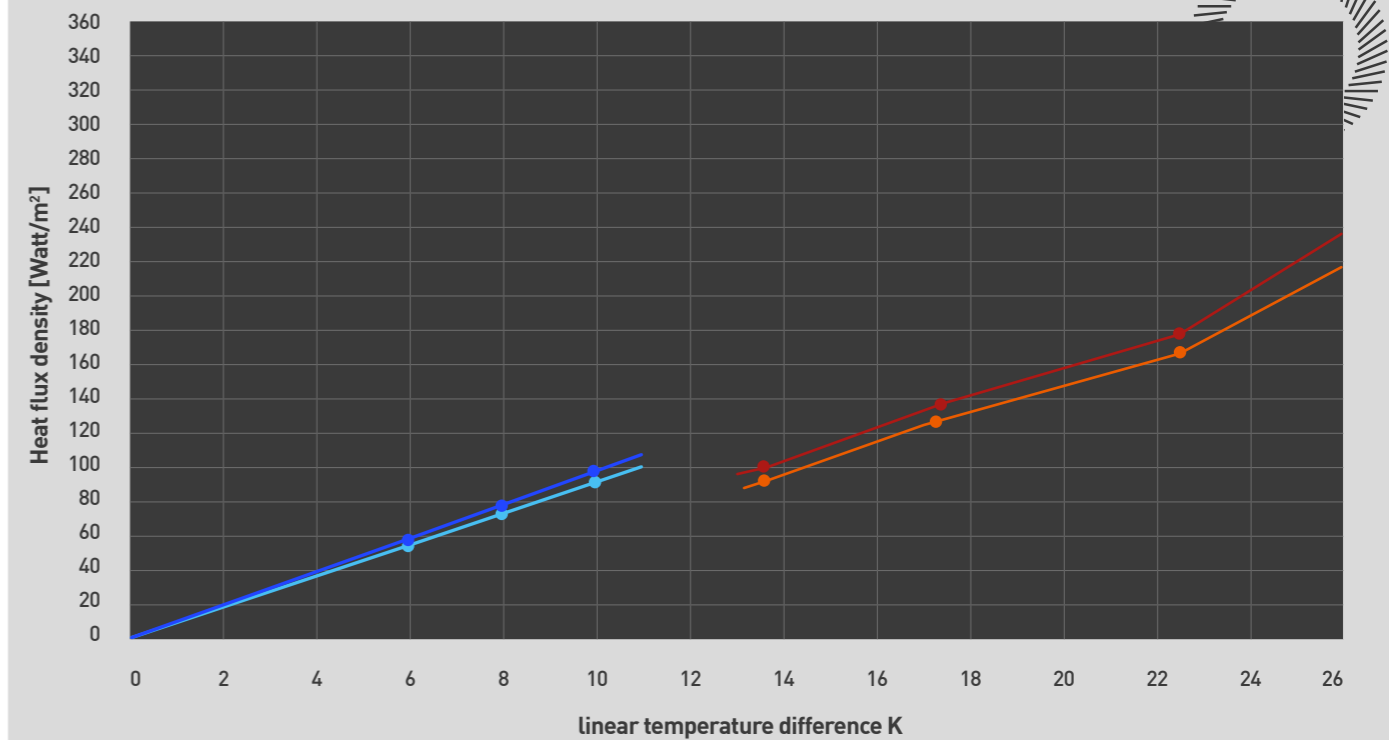

Cooling capacity calculation example for: Flow temperature 15°C / return temperature 17°C

linear temperature difference K	6	8	10
Room temperature °C	22	24	26
Metal ceiling - strip grid system with acoustic fleece, with insulation W/m <sup>2</sup>	53	71	90
Metal ceiling - strip grid system with acoustic fleece, without insulation W/m <sup>2</sup>	54	74	94

Calculation example for: flow temperature 40°C / return temperature 35°C

linear temperature difference K	13,5	17,5	22,5
Room temperature °C	24	20	15
Metal ceiling - strip grid system with acoustic fleece, with insulation W/m <sup>2</sup>	99	132	173
Metal ceiling - strip grid system with acoustic fleece, without insulation W/m <sup>2</sup>	103	138	181

Test certificates required?  
Please contact [service@aquatherm.de](mailto:service@aquatherm.de)



## aquatherm black performance values: Free convection

Standard heating **output** according to DIN EN 14037-2  
Standard **cooling** capacity according to DIN EN 14240: 2004-04

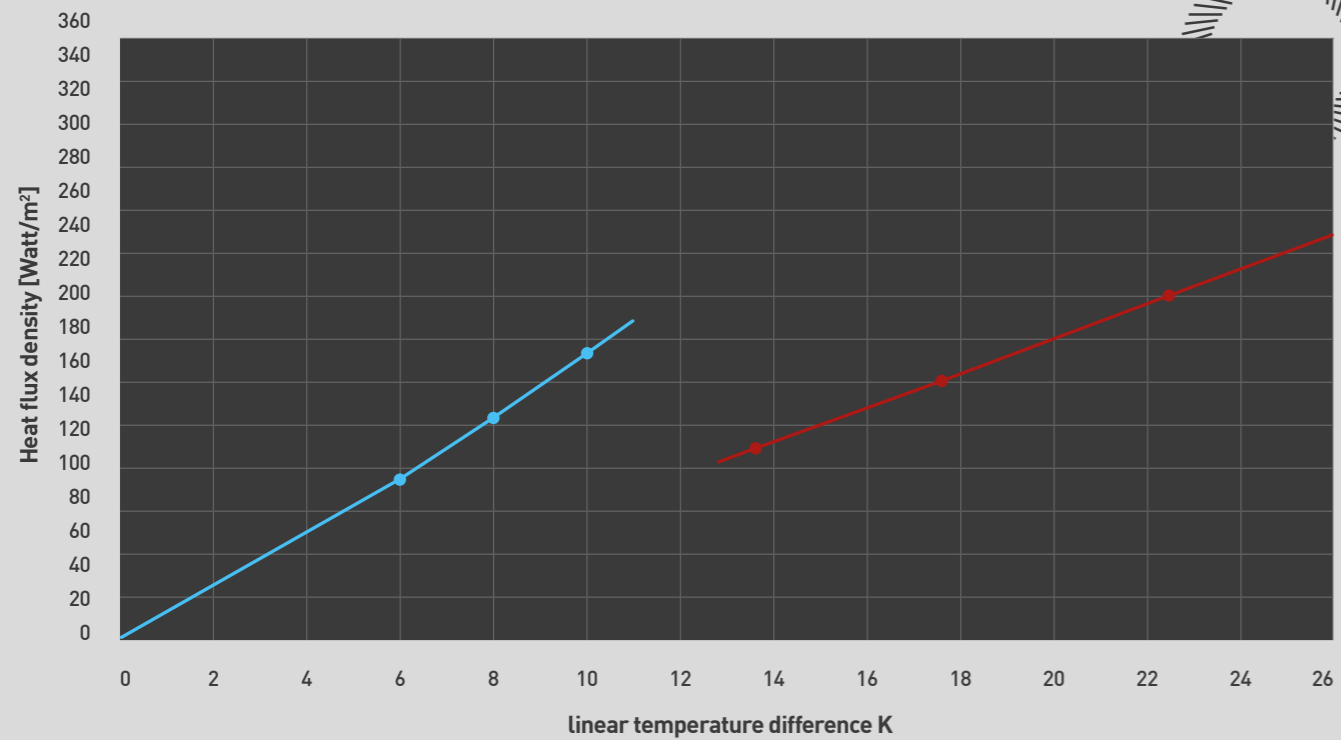

Cooling capacity calculation example for: Flow temperature 15°C / return temperature 17°C

linear temperature difference K	6	8	10
Room temperature °C	22	24	26
free convection W/m <sup>2</sup>	93	128	164

Calculation example for: flow temperature 40°C / return temperature 35°C

linear temperature difference K	13,5	17,5	22,5
Room temperature °C	24	20	15
free convection W/m <sup>2</sup>	114	152	200

## aquatherm black performance values: Floor - screed

Standard heating **output** according to DIN EN 14037-2  
Standard **cooling** capacity according to DIN EN 14240: 2004-04

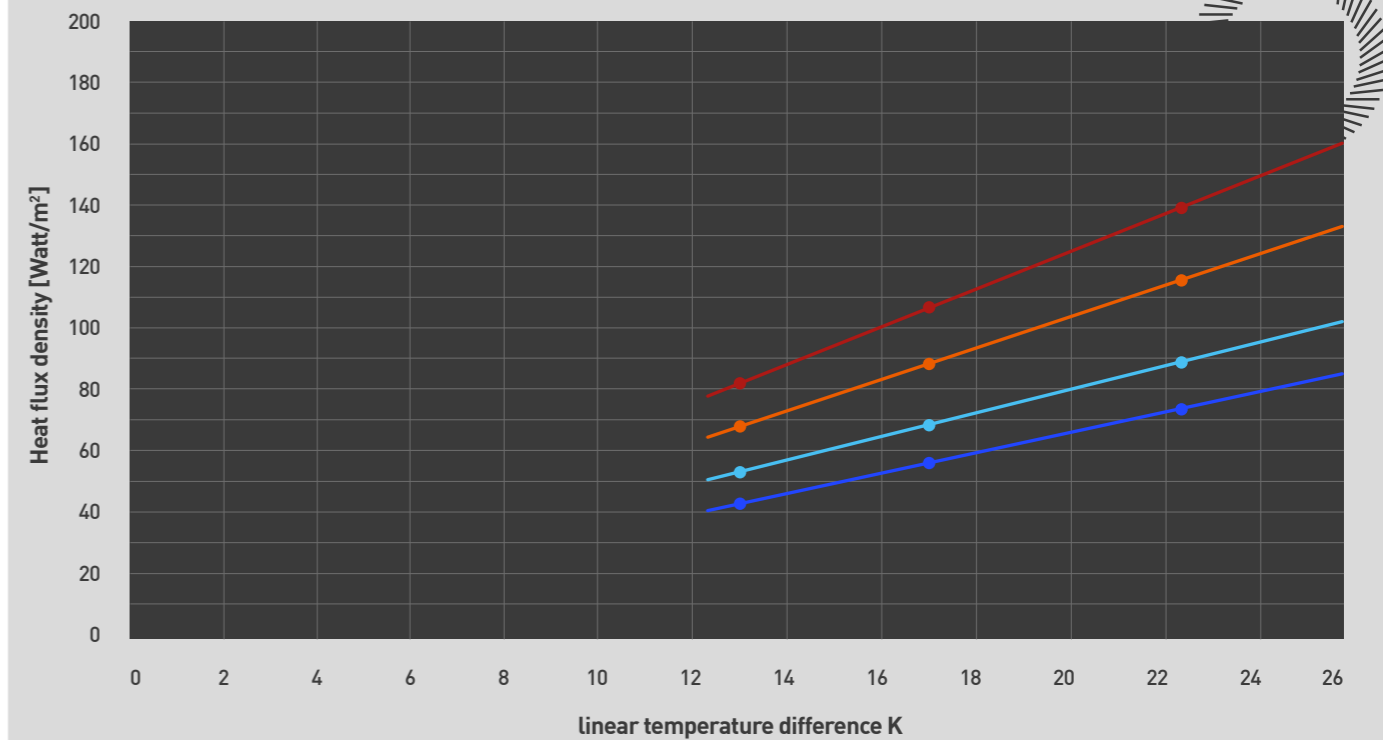

Cooling capacity calculation example for: Flow temperature 40°C / return temperature 35°C

linear temperature difference K	13,5	17,5	22,5
Room temperature °C	24	20	15
CT screed 45mm - 0.02 e.g. tile thickness	83	108	138
CT screed 45mm - 0.05 e.g. laminate	69	90	115
CT screed 45mm - 0.1 e.g. carpet	54	70	90
CT screed 45mm - 0.15 e.g. parquet	44	58	74

Test certificates required?  
Please contact [service@aquatherm.de](mailto:service@aquatherm.de)

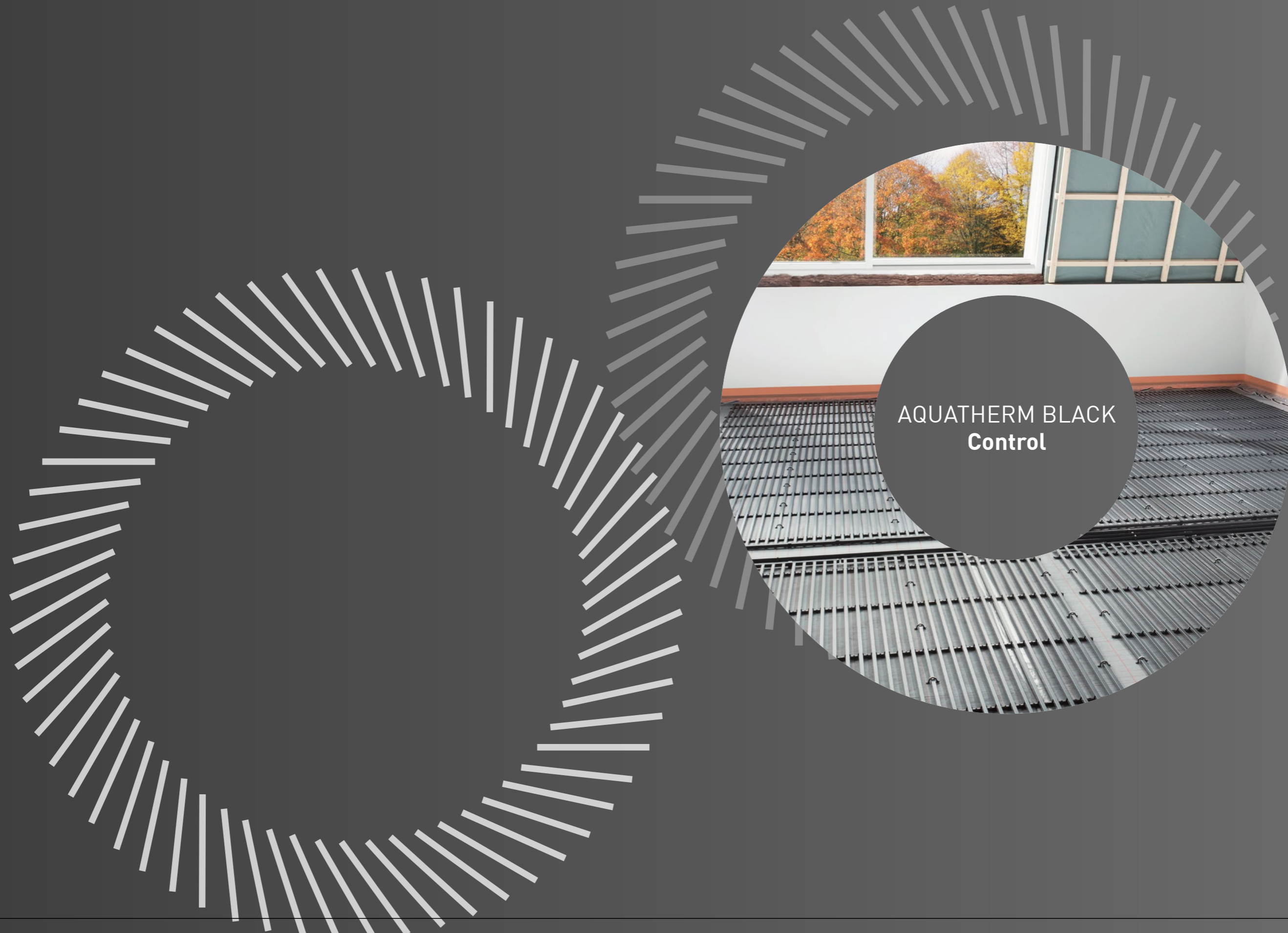

AQUATHERM BLACK  
Control





## Control concept

### General description

aquatherm offers a complete system with all the necessary components for optimum control of a surface-heating or cooling system up to the heating/cooling circuit manifold interface. Pre-controls, changeover or mixing valves are not included in the delivery programme and must be provided externally. This applies to new and old buildings, for integration into existing systems and for small areas or large properties.

For surface heating and cooling systems, individual room control is mandatory in accordance with EnEV, provided that the property is tempered via this. Individual room control can only be dispensed with if the base load is covered. The peakloads are then covered by a separate cooling/heating system with individual room control.

The room temperature is controlled via a room thermostat that is mounted on the wall. It is important to ensure that the room thermostat is not installed behind curtains or drapes, in draughts or exposed to direct sunlight. In cooling mode, if the temperature falls below the preset setpoint temperature and in heating mode if it exceeds it, the room thermostat switches an actuator which closes or reopens a control valve.

In systems that are both heated and cooled, the signal for the central switchover between heating and cooling mode is issued via an automatic management module using a potential-free switching output.

If the surface temperature of the system in the ceiling or wall installed in cooling mode is below the dewpoint temperature, condensation may form on the surface. This can be avoided in various ways.

### Interruption of the volume flow

An external temperature sensor is used to prevent condensation forming at critical points, such as directly at the cold water supply. The NTC temperature sensor works in combination with a digitally programmable wireless room thermostat with hygostat (humidity sensor). The wireless room thermostat and NTC temperature sensor permanently monitor the temperature and humidity behaviour between the cooling level and the room. As soon as a critical thermal range is reached, the cooling function is stopped and the cooling zone is closed.

### Adjustment of the flow temperature (external control)

However, if the output of the cooling ceiling is not to be interrupted, it is possible to regulate the flow temperature depending on the dew point temperature of reference rooms. A control system continuously calculates the dew point using a humidity and temperature sensor. This keeps the flow temperature permanently 0.5 K to 1.0 K above the critical temperature. Condensation cannot form in the room.

In addition to the solutions described above, the supply of humid air into the room through open windows can be monitored with window contacts. The processing of the "open window" signal must then be integrated into the selected control system.

#### Note:

Only fit dew point sensors to plastic pipes.

### Control concept: Scheme for individual room control heating via radio with zone valve and/or heating circuit manifold

Individual room control heating via radio in the two-pipe system is realised via a room thermostat with wireless radio transmission. This is connected to a wireless control manifold with an on-site zone valve or the actuators of a heating circuit manifold in order to facilitate the assignment of the individual components and control circuits. Depending on the version of the radio control distributor, up to 6 room thermostats and 12 actuators can be connected. If required, the radio control distributor can be extended by up to 4 additional zones and 8 actuators (art. no. 9700094422).

The system voltage must be taken into account when selecting the components.

#### Variant 1 -

Via zone valve provided by customer

#### Variant 2 -

Heating circuit manifold

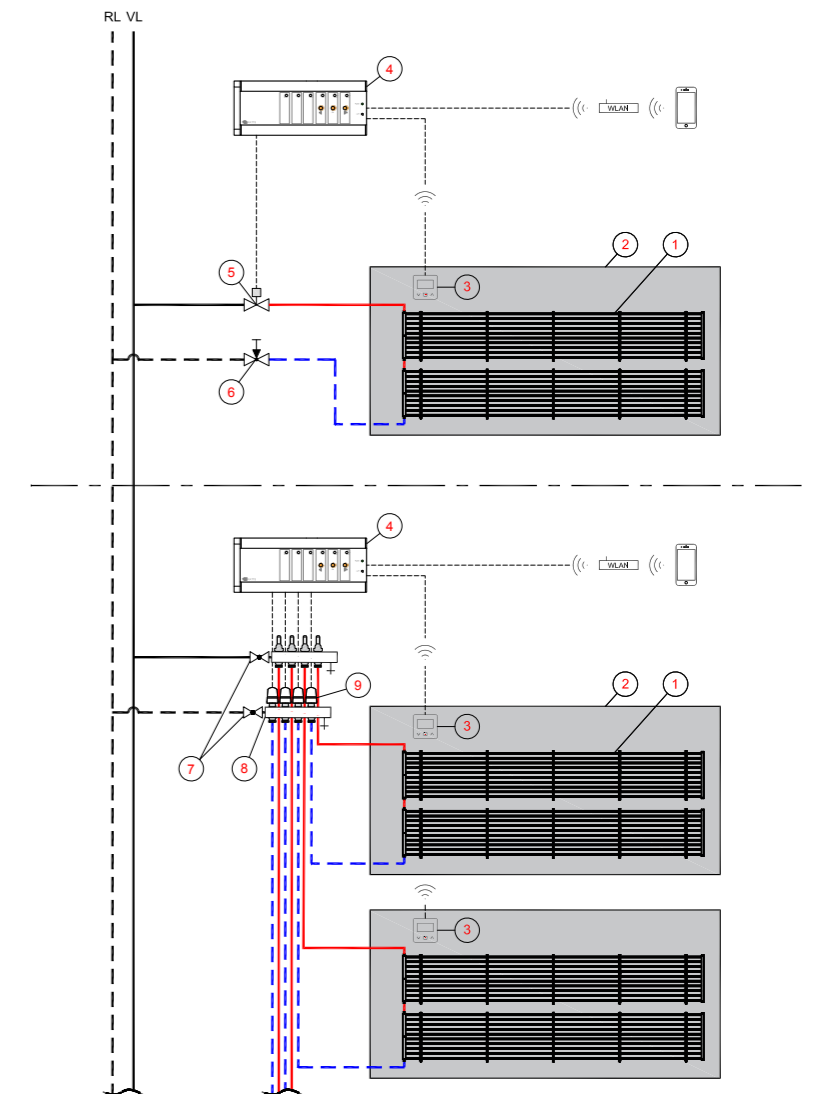

1. Heating/cooling circuit
2. Control area
3. Wireless room thermostat (art. no. 9700094418)
4. Master radio control distributor (art. no. 9700094422)
5. Zone valve (on site)

6. Line regulating valve (on site)
7. Ball valve set (art. no. 9700094513)
8. Heating circuit manifold
9. Actuators (art. no. 9700094102)



### Control concept: Scheme for individual room control cooling via radio with zone valve and/or heating circuit manifold

The individual room heating/cooling control in the two-pipe system is realised via a room thermostat with hygrostat and connected external sensor for cooling mode. This is switched to a wireless control manifold with a zone valve provided by the customer or with the actuators of a heating/cooling circuit manifold in order to facilitate the assignment of the individual components and control circuits. If several connection systems are in use, they can be connected in series using a master and slave function. An external temperature sensor is used to prevent condensation forming at critical points, such as directly on the cold water flow. The NTC temperature sensor works in combination with the digitally programmable room thermostat with hygrostat (humidity sensor). The wireless room thermostat and NTC temperature sensor permanently monitor the temperature and humidity behaviour between the cooling level and the room. The signal for the central switchover between heating and cooling mode is issued via an automatic management module using a potential-free switching output.

Individual heating and cooling of individual rooms or smaller zones is not possible with this two-pipe system. The system voltage must be taken into account when selecting the components.

#### Variant 1 - Via zone valve provided by customer

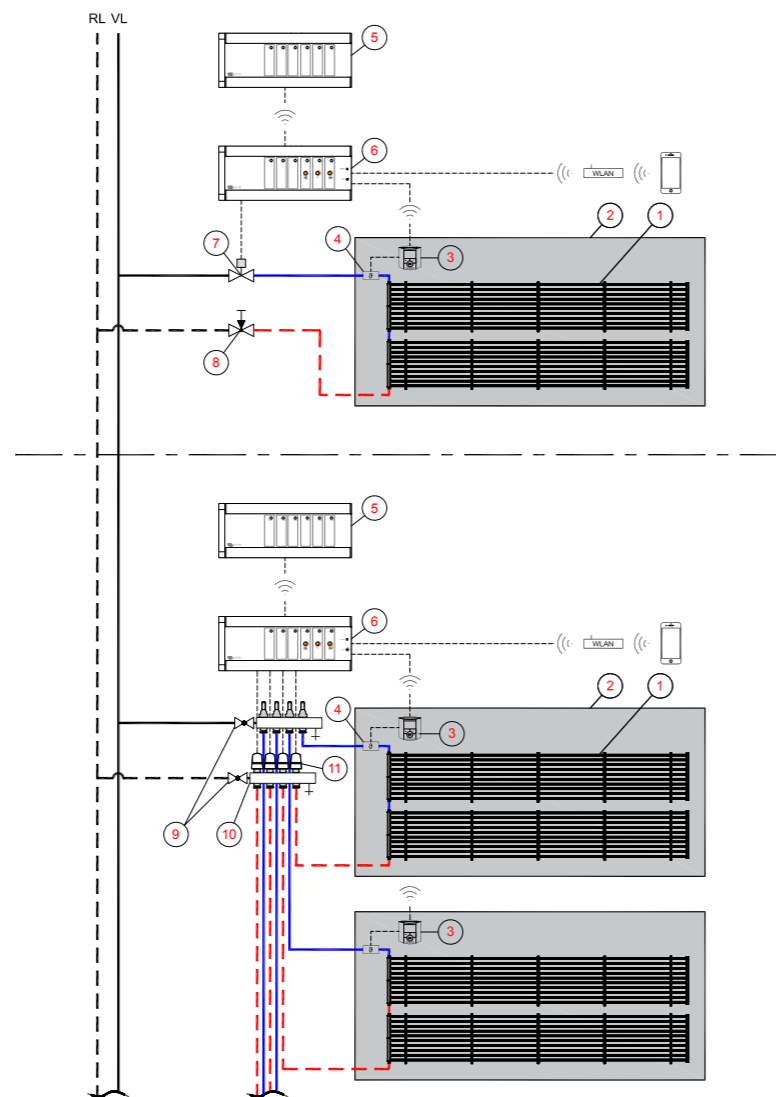

#### Variant 2 - Heating/cooling circuit manifold

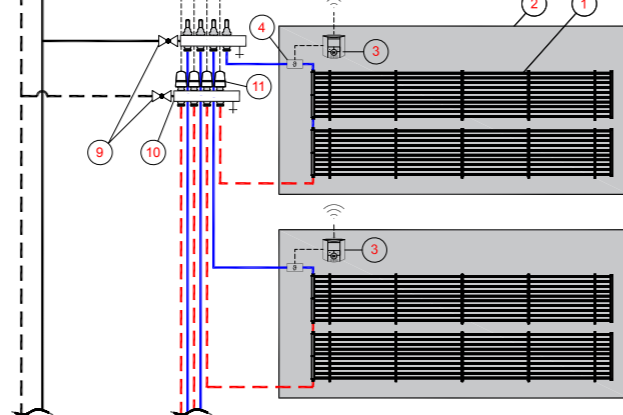

1. Heating/cooling circuit
2. Control area
3. Wireless room thermostat with hygrostat [art. no. 9700094420]
4. External sensor [art. no. 9700094426]
5. Heating/cooling management module [art. no. 9700094421]
6. Master radio control distributor [art. no. 9700094422]

7. Zone valve (on site)
8. Line regulating valve (on site)
9. Ball valve set [art. no. 9700094513]
10. Heating circuit manifold
11. Actuators [art. no. 9700094103]

### Control concept: Scheme for individual room control heating via radio with zone valve Connection pipework via Tichelmann manifold (short version)

Individual room control heating via Tichelmann manifolds with zone valves provided by the customer ensures a uniform flow through the control circuits. Equal lengths of flow and return pipes of the control circuits result in equal pressure losses and volume flows. The room thermostat and zone valve are connected together to a wireless control manifold to ensure individualised and precise control and demand-based regulation of the individual control zones.

The system voltage must be taken into account when selecting the components.

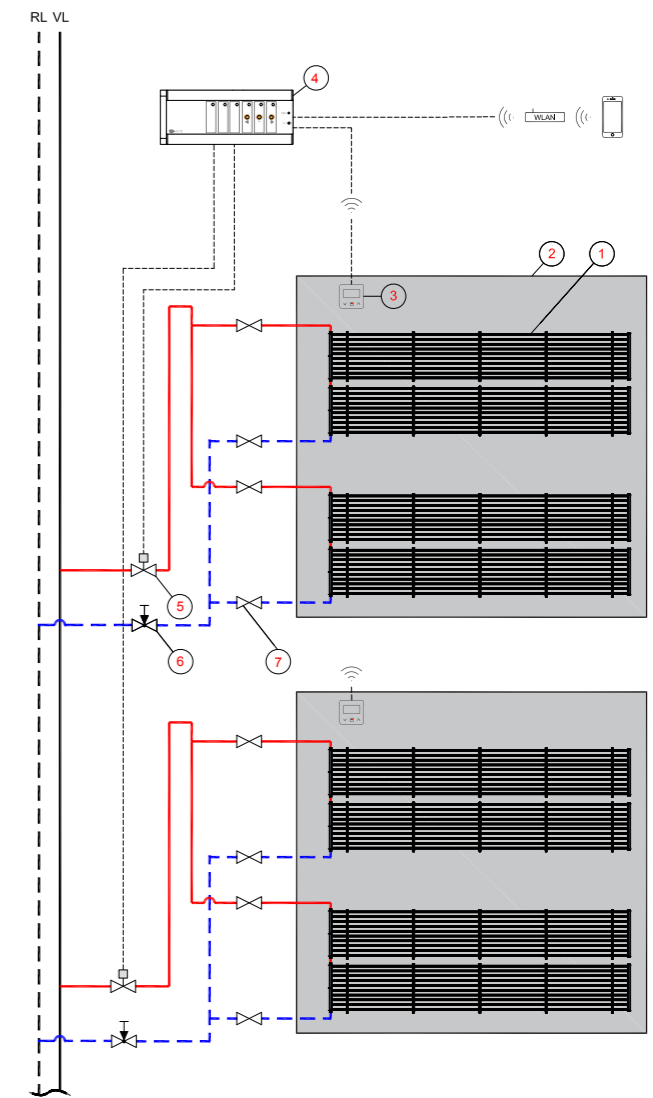

1. Heating/cooling circuit
2. Control area
3. Wireless room thermostat [art. no. 9700094418]
4. Master radio control distributor [art. no. 9700094422]

5. Zone valve (on site)
6. Line regulating valve (on site)
7. Ball valve/shut-off device



### Control concept: Scheme of individual room control heating/cooling via radio with zone valve Connection pipework via Tichelmann manifold (short version)

The individual room heating/cooling control via Tichelmann manifolds with zone valves provided by the customer ensures a uniform flow through the control circuits. Equal lengths of flow and return pipes of the control circuits result in equal pressure losses and volume flows. The room thermostat and zone valve are connected together to a radio control manifold to ensure individual and precise control and demand-led regulation of the individual control zones. An external temperature sensor is used to prevent condensation forming at critical points, such as directly on the cold water flow. The NTC temperature sensor works in combination with the digitally programmable room thermostat with hygrostat (humidity sensor). The wireless room thermostat and NTC temperature sensor permanently monitor the temperature and humidity behaviour between the cooling level and the room. The signal for the central switchover between heating and cooling mode is issued via an automatic management module using a potential-free switching output.

The system voltage must be taken into account when selecting the components.

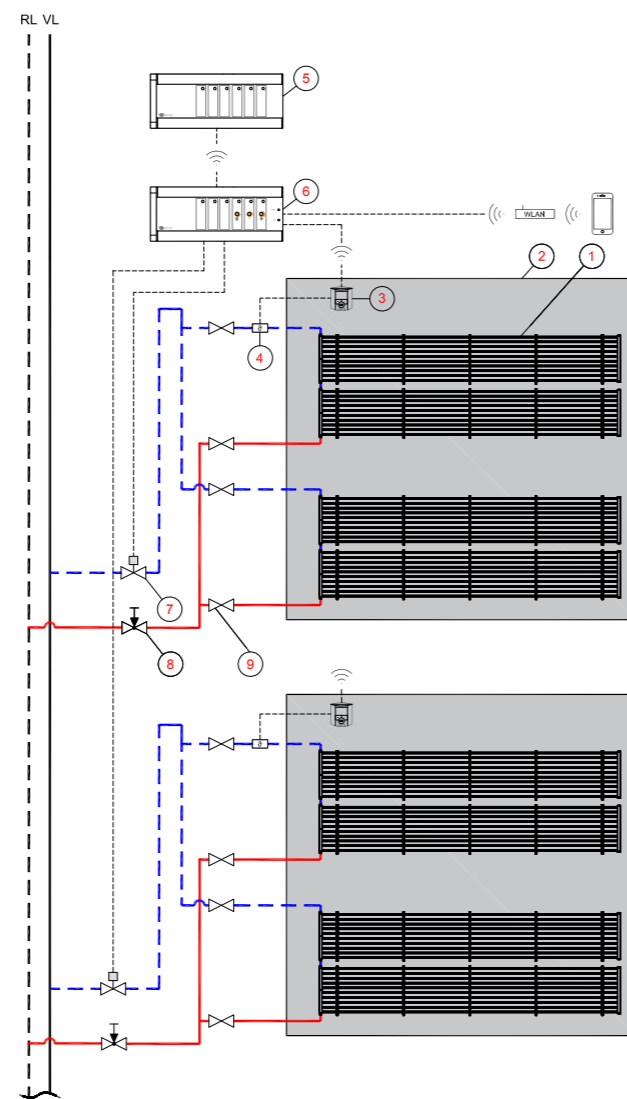

1. Heating/cooling circuit
2. Control area
3. Wireless room thermostat with hygrostat (art. no. 9700094420)
4. External sensor (art. no. 9700094426)
5. Heating/cooling management module (art. no. 9700094421)

6. Master radio control distributor (art. no. 9700094422)
7. Zone valve (on site)
8. Line regulating valve (on site)
9. Ball valve/shut-off device

### Control concept: Scheme for individual room control heating/cooling in a four-pipe system with room thermostat and 6-way zone valve

The individual room control for heating/cooling in the four-pipe system is realised via a room thermostat with an external temperature sensor for cooling mode and a radio receiver for controlling the 6-way control ball valve provided by the customer. The room thermostat ensures individualised and precise control and demand-based regulation of the heating/cooling ceiling via the radio receiver. The 6-way characterised control valve takes over the control function of up to four globe valves and can optimally regulate various control circuits using an additional balancing valve. Alternatively, an electronically pressure-independent 6-way zone valve ensures automatic and permanent hydraulic balancing of the control zone and ensures the correct water volume in the event of differential pressure changes in partial load operation by means of electronic flow control.

The system voltage must be taken into account when selecting the components.

#### Variant 1 - 6-way zone valve with additional line regulating valve

#### Variant 2 - 6-way zone valve with Tichelmann

#### Variant 3 - Electr. pressure-independent 6-way zone valve

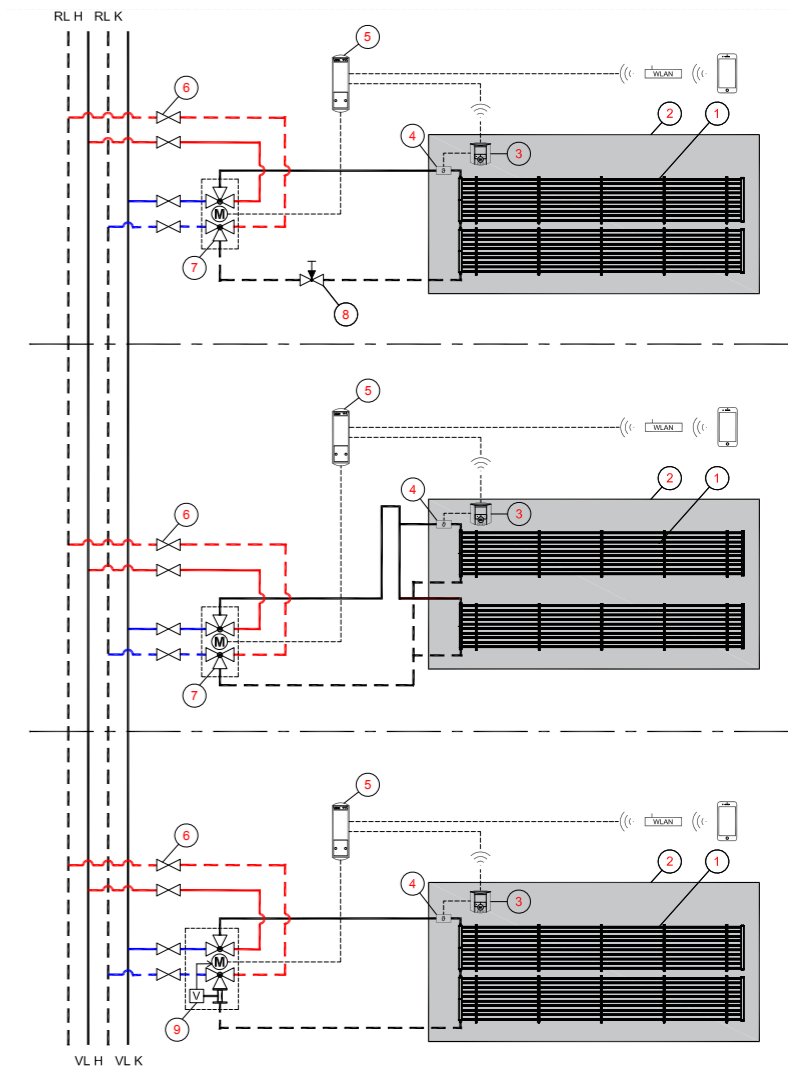

1. Heating/cooling circuit
2. Control area
3. Wireless room thermostat with hygrostat (art. no. 9700094420)
4. External sensor (art. no. 9700094426)
5. Individual radio receiver (art. no. 9700094424)

6. Ball valve/shut-off device
7. 6-way zone valve (supplied by customer)
8. Line regulating valve (on site)
9. Electronic pressure-independent 6-way zone valve (on site)



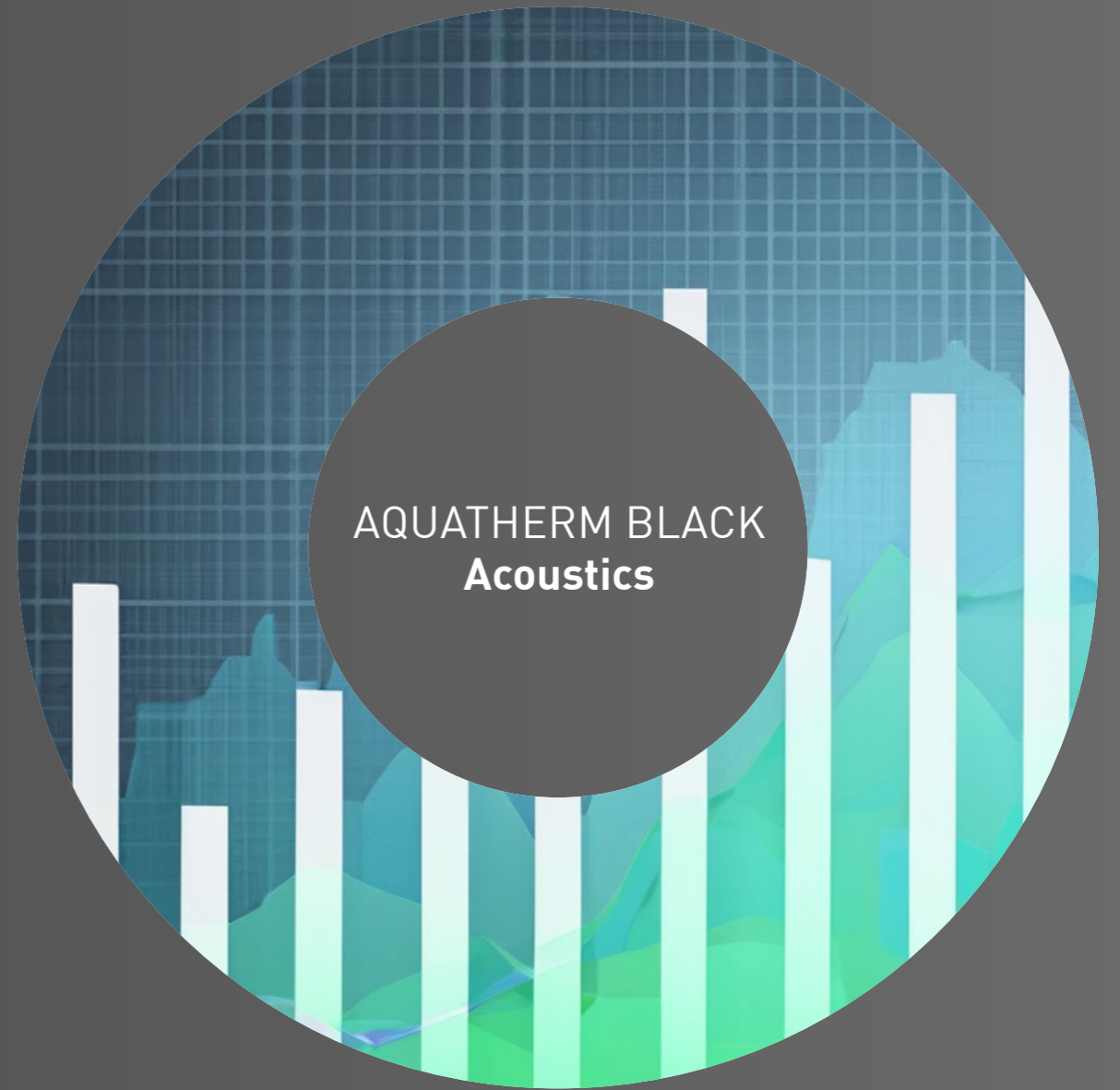



### Sound absorption

Sound absorption refers to the process of reducing sound energy. Reflection of the waves at the room boundaries creates a diffuse sound field in which the direct sound of the sound source is superimposed with reflective sound components and acts from all directions with approximately the same intensity. If the reflections at the room boundaries can be reduced, the room becomes quieter. The absorption coefficient

$\alpha$  indicates how large the absorbed proportion of the total incident sound is:

At  $\alpha = 1$ , the entire incident sound is absorbed, i.e. reflection no longer takes place. At  $\alpha = 0.5$ , 50% of the sound energy is absorbed and 50% is reflected.

#### aquatherm black acoustic values of a 12/25 Q Drywall ceiling with insulation layer

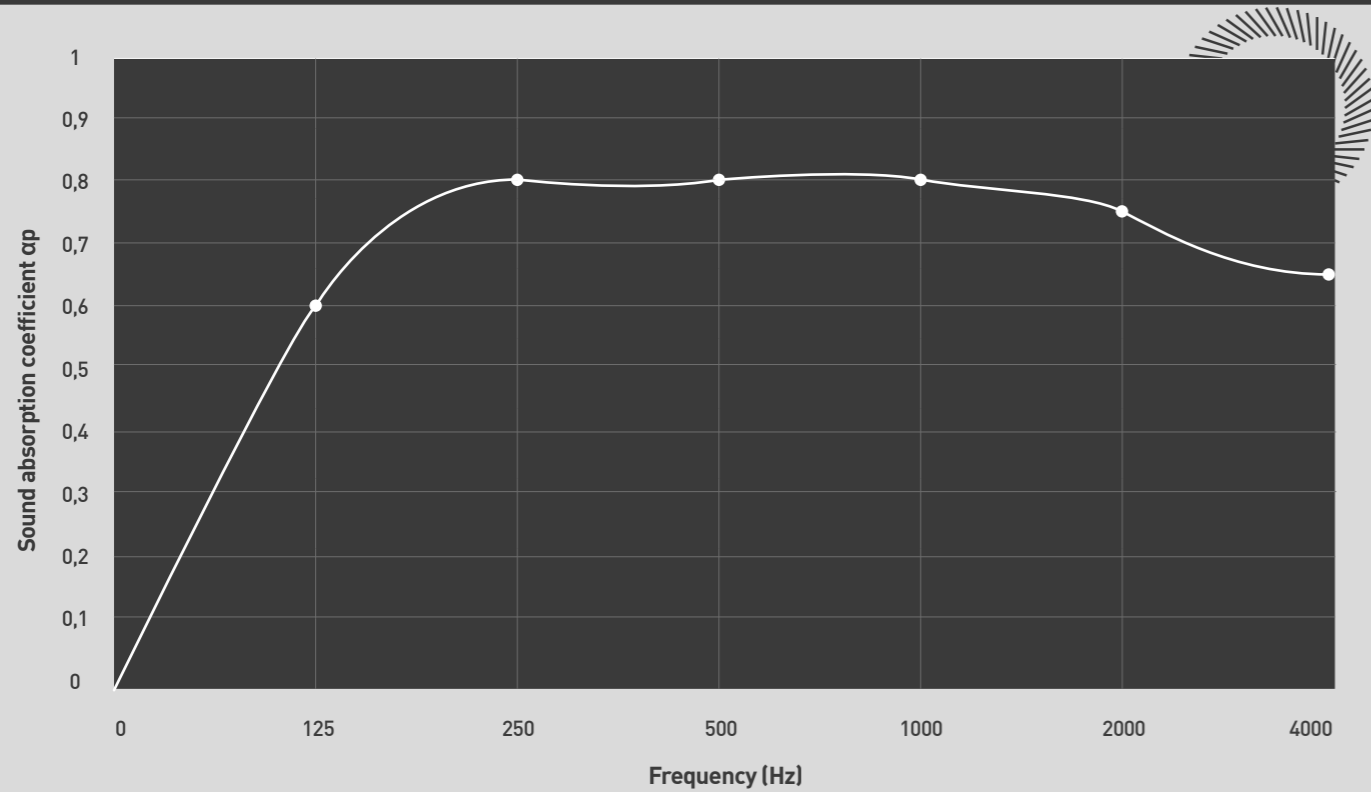

Sound absorption coefficient of a Drywall ceiling with proportional perforation of 23 %, type 12/25 Q  
 Evaluation according to ISO 354  
 Practical sound absorption coefficient according to ISO 11654  
 $\alpha_w = 0,70$  (L)  
 Sound absorption class C

Sound acoustic values						
Frequency [Hz]	125	250	500	1000	2000	4000
Oktave $\alpha_p$	0,60	0,80	0,80	0,80	0,75	0,65

#### aquatherm black acoustic values of a 12/25 Q Drywall ceiling without insulation layer

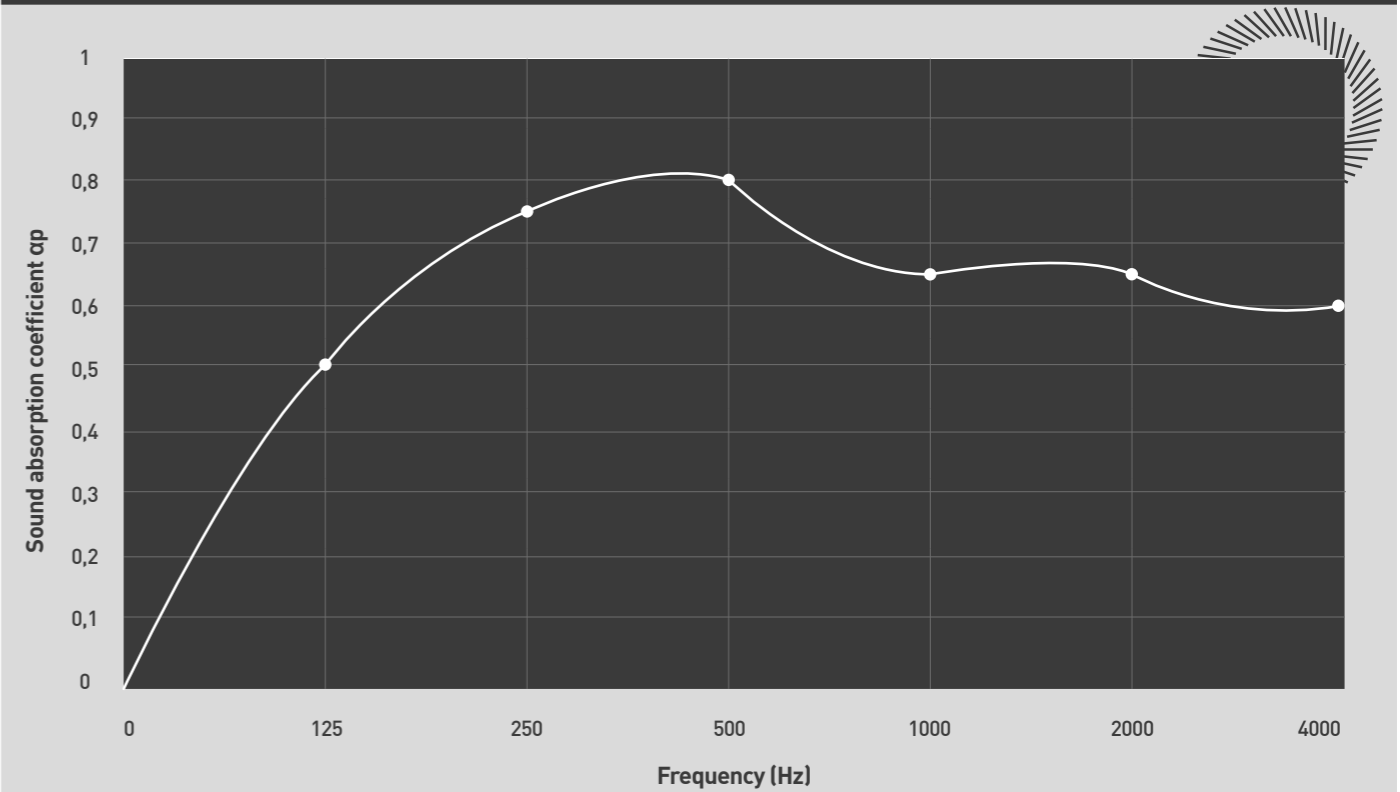

Sound absorption coefficient of a Drywall ceiling with proportional perforation of 23 %, type 12/25 Q  
 Evaluation according to ISO 354  
 Practical sound absorption coefficient according to ISO 11654  
 $\alpha_w = 0,70$  (L)  
 Sound absorption class C

Sound acoustic values						
Frequency [Hz]	125	250	500	1000	2000	4000
Oktave $\alpha_p$	0,50	0,75	0,80	0,65	0,65	0,60



### Sound absorption

Sound absorption refers to the process of reducing sound energy. Reflection of the waves at the room boundaries creates a diffuse sound field in which the direct sound of the sound source is superimposed with reflective sound components and acts from all directions with approximately the same intensity. If the reflections at the room boundaries can be reduced, the room becomes quieter. The absorption coefficient

$\alpha$  indicates how large the absorbed proportion of the total incident sound is:

At  $\alpha = 1$ , the entire incident sound is absorbed, i.e. reflection no longer takes place. At  $\alpha = 0.5$ , 50% of the sound energy is absorbed and 50% is reflected.

#### aquatherm black acoustic values of a Standard-Drywall ceiling with insulation layer

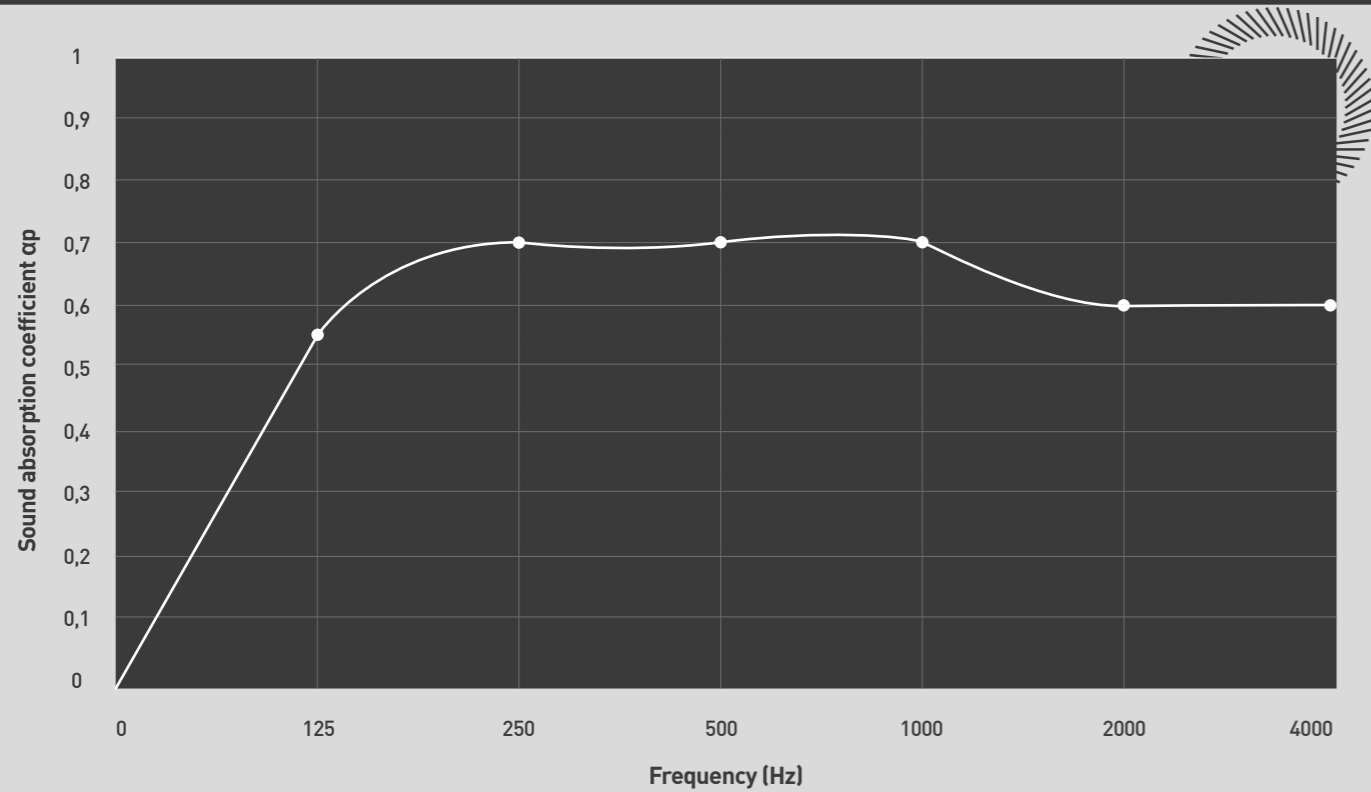

Sound absorption coefficient of a Drywall ceiling with proportional perforation of 15,5 %, type 8/18 R  
 Evaluation according to ISO 354  
 Practical sound absorption coefficient according to ISO 11654  
 $\alpha_w = 0,70$  (L)  
 Sound absorption class C

Sound acoustic values						
Frequency [Hz]	125	250	500	1000	2000	4000
Oktave $\alpha_w$	0,55	0,70	0,70	0,70	0,60	0,60

#### aquatherm black acoustic values of a Standard-Drywall ceiling without insulation layer

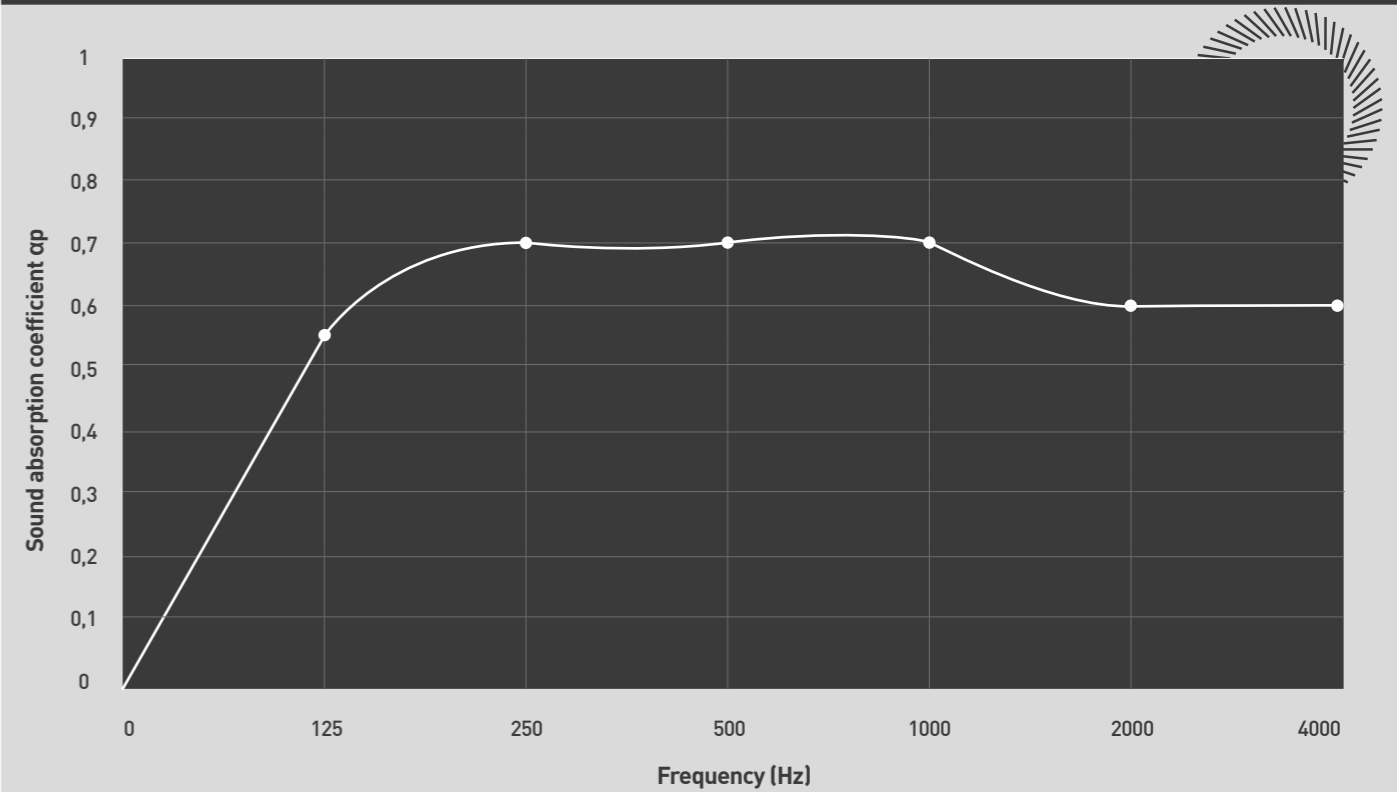

Sound absorption coefficient of a Drywall ceiling with proportional perforation of 15,5 %, type 8/18 R  
 Evaluation according to ISO 354  
 Practical sound absorption coefficient according to ISO 11654  
 $\alpha_w = 0,70$  (L)  
 Sound absorption class C

Sound acoustic values						
Frequency [Hz]	125	250	500	1000	2000	4000
Oktave $\alpha_w$	0,50	0,70	0,75	0,60	0,55	0,55





### Sound absorption

Sound absorption refers to the process of reducing sound energy. Reflection of the waves at the room boundaries creates a diffuse sound field in which the direct sound of the sound source is superimposed with reflective sound components and acts from all directions with approximately the same intensity. If the reflections at the room boundaries can be reduced, the room becomes quieter. The absorption coefficient

$\alpha$  indicates how large the absorbed proportion of the total incident sound is:

At  $\alpha = 1$ , the entire incident sound is absorbed, i.e. reflection no longer takes place. At  $\alpha = 0.5$ , 50% of the sound energy is absorbed and 50% is reflected.

### aquatherm black acoustic values of a metal ceiling sail

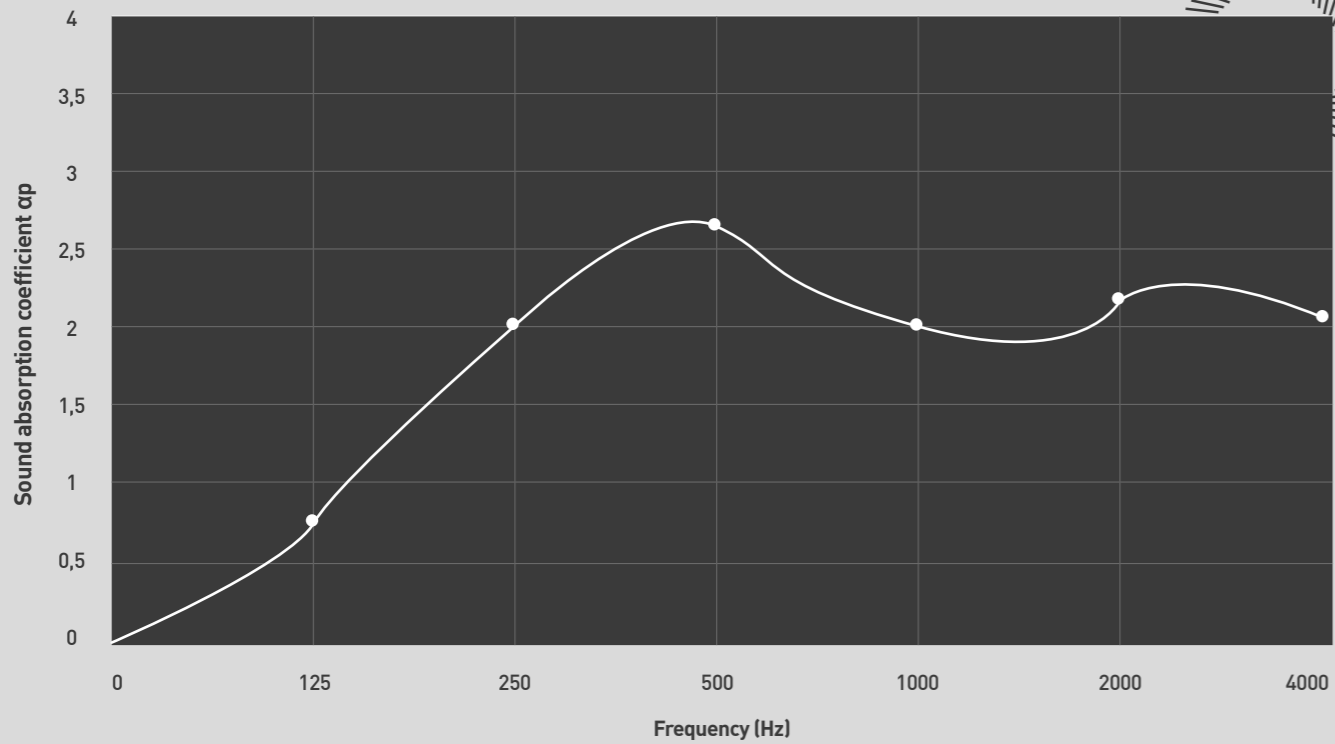

Sound absorption coefficient bei MetallCeilingsystem with proportional perforation type 2516, perforation percentage 16%  
 Evaluation according to ISO 354  
 Practical sound absorption coefficient according to ISO 11654  
 $\alpha_w = 0,70$  (L)  
 Sound absorption class C

#### Sound acoustic values

Frequency (Hz)	125	250	500	1000	2000	4000
Oktave $\alpha_p$	0,70	2,00	2,00	2,00	2,20	2,10

### aquatherm black acoustic values of a metal ceiling sail with 20 % holes

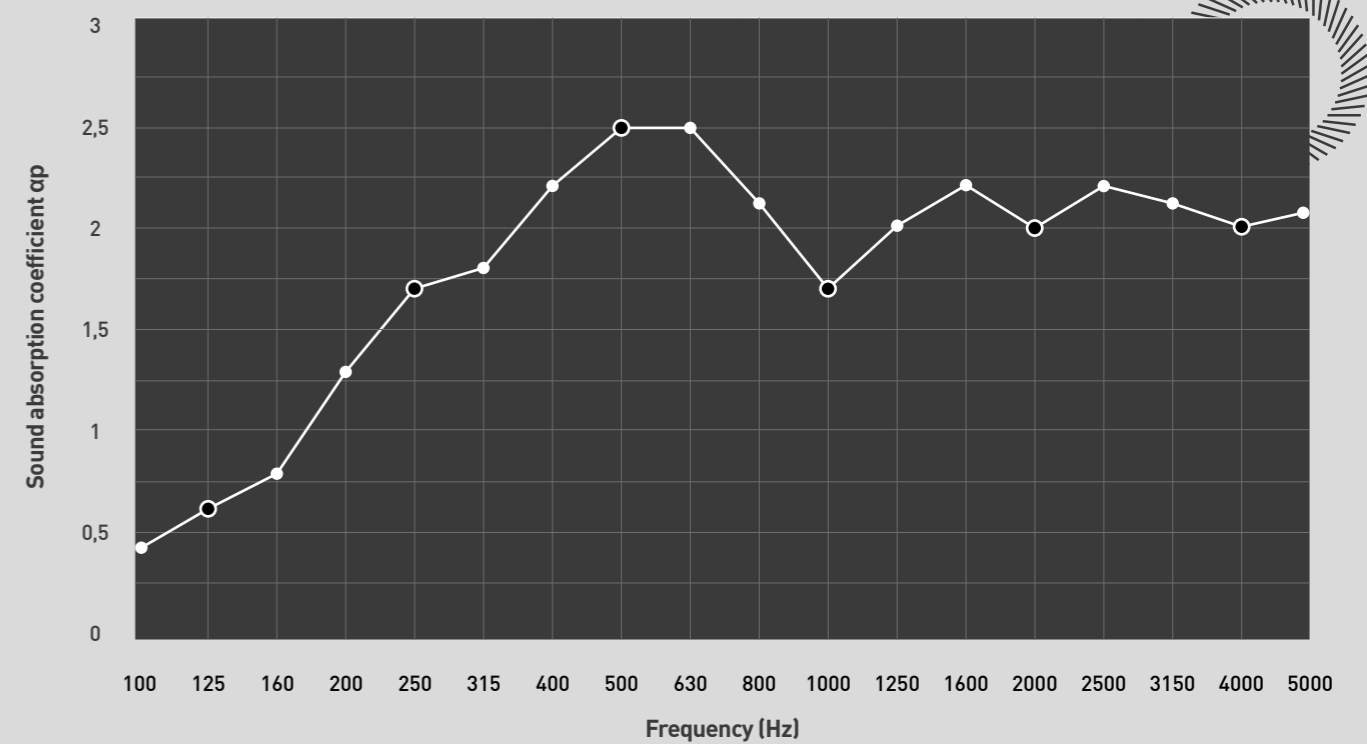

Sound absorption coefficient for metal ceiling system with proportional perforation type 1620, perforation percentage 20 %  
 Evaluation according to ISO 354  
 Practical sound absorption coefficient according to ISO 11654  
 $\alpha_w = 0.70$  (L)  
 Sound absorption class C

#### Sound acoustic values

Frequency (Hz)	125	250	500	1000	2000	4000
Third $\alpha_s$	0,60	1,70	2,50	1,70	2,00	2,00



## Sound absorption

Sound absorption refers to the process of reducing sound energy. Reflection of the waves at the room boundaries creates a diffuse sound field in which the direct sound of the sound source is superimposed with reflective sound components and acts from all directions with approximately the same intensity. If the reflections at the room boundaries can be reduced, the room becomes quieter. The absorption coefficient

$\alpha$  indicates how large the absorbed proportion of the total incident sound is:

At  $\alpha = 1$ , the entire incident sound is absorbed, i.e. reflection no longer takes place. At  $\alpha = 0.5$ , 50% of the sound energy is absorbed and 50% is reflected.

### aquatherm black acoustic values - Metal cassette with inlaid grid

Diameter: 0,7 mm - Perforation percentage: 4 %

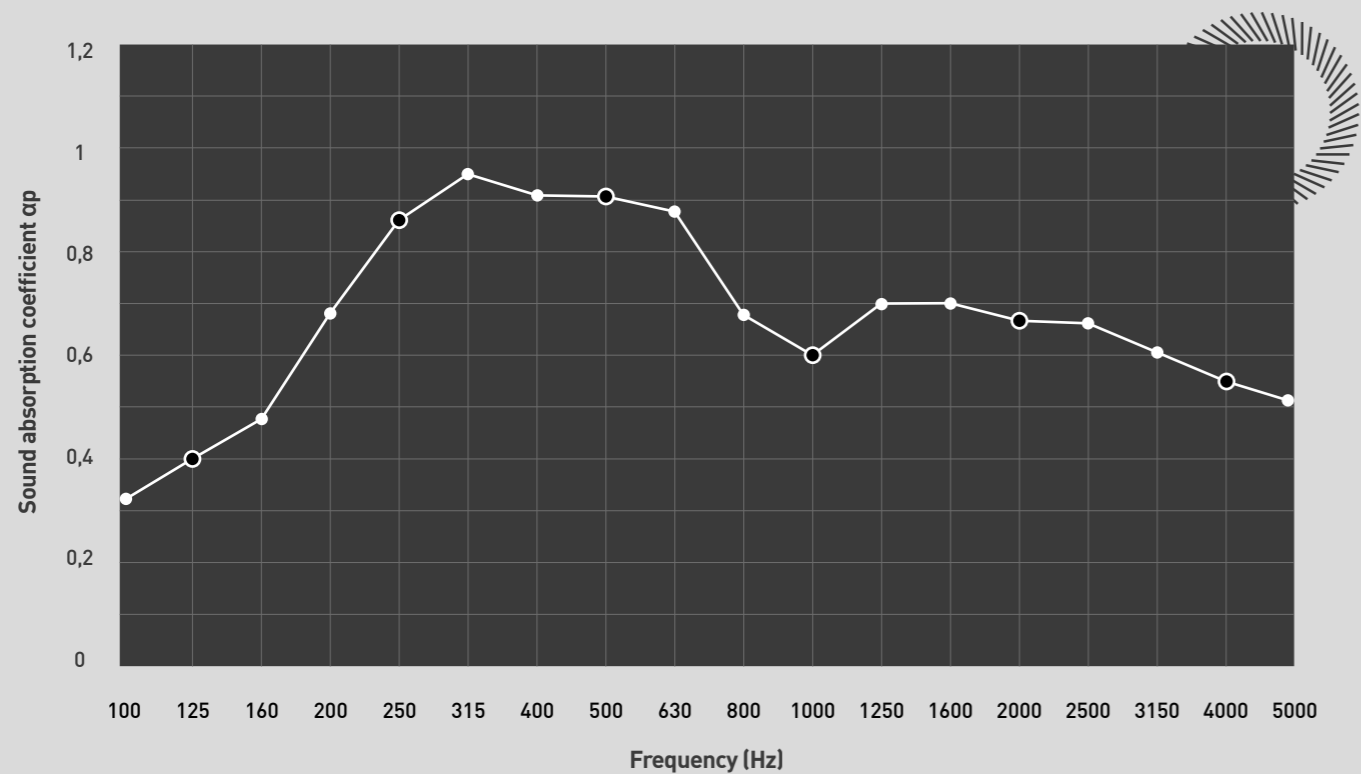

Sound absorption coefficient for metal ceiling system with proportional perforation type 2516

Evaluation according to ISO 354

Practical sound absorption coefficient according to ISO 11654

$\alpha_w = 0,70$  (L)

Sound absorption class C

#### Sound acoustic values

Frequency (Hz)	125	250	500	1000	2000	4000
Terz $\alpha_s$	0,40	0,85	0,91	0,60	0,67	0,55

### aquatherm black acoustic values - Metal cassette with inlaid grid

Diameter: 1,6 mm - Perforation percentage: 20 %

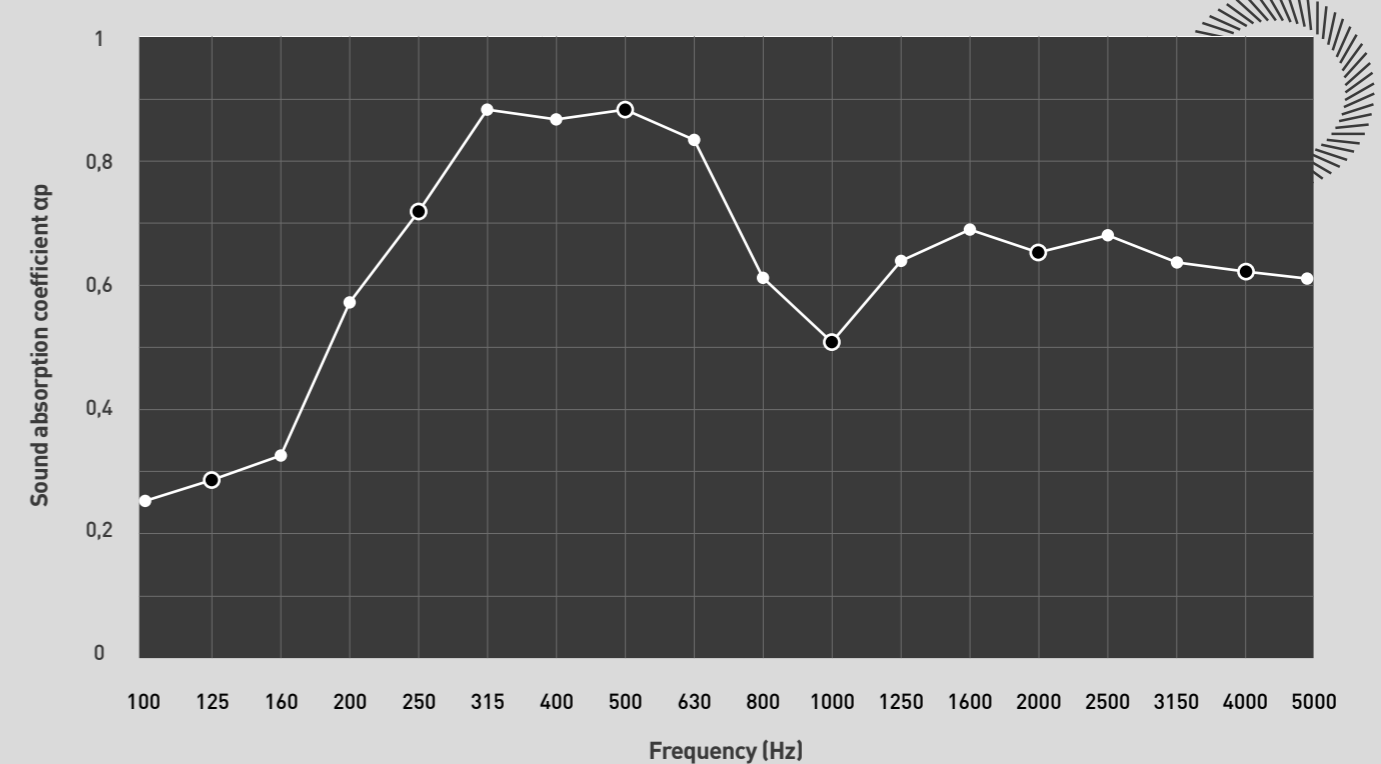

Sound absorption coefficient for metal ceiling system with proportional perforation type 2516

Evaluation according to ISO 354

Practical sound absorption coefficient according to ISO 11654

$\alpha_w = 0,70$  (L)

Sound absorption class C

#### Sound acoustic values

Frequency (Hz)	125	250	500	1000	2000	4000
Terz $\alpha_s$	0,28	0,72	0,87	0,51	0,65	0,62



## Sound absorption

Sound absorption refers to the process of reducing sound energy. Reflection of the waves at the room boundaries creates a diffuse sound field in which the direct sound of the sound source is superimposed with reflective sound components and acts from all directions with approximately the same intensity. If the reflections at the room boundaries can be reduced, the room becomes quieter. The absorption coefficient

$\alpha$  indicates how large the absorbed proportion of the total incident sound is:

At  $\alpha = 1$ , the entire incident sound is absorbed, i.e. reflection no longer takes place. At  $\alpha = 0.5$ , 50% of the sound energy is absorbed and 50% is reflected.

### aquatherm black acoustic values - Metal cassette with inlaid grid

Diameter: 1,8 mm - Perforation percentage: 21 %

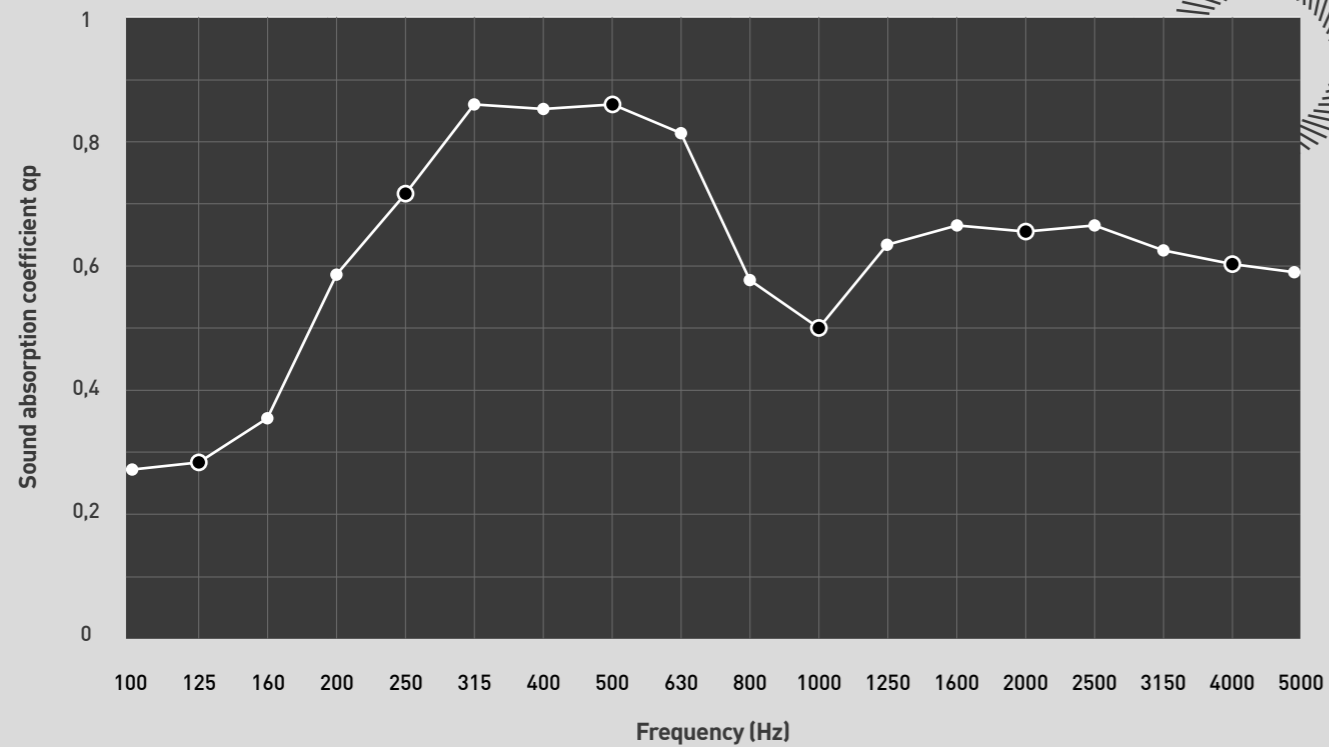

Sound absorption coefficient bei MetallCeilingsystem with proportional perforation type 2516

Evaluation according to ISO 354

Practical sound absorption coefficient according to ISO 11654

$\alpha_w = 0,70$  (L)

Sound absorption class C

Sound acoustic values						
Frequency (Hz)	125	250	500	1000	2000	4000
Terz $\alpha_s$	0,29	0,71	0,86	0,50	0,64	0,61

### aquatherm black acoustic values - Metal cassette with inlaid grid

Diameter: 2,5 mm - Perforation percentage: 16 %

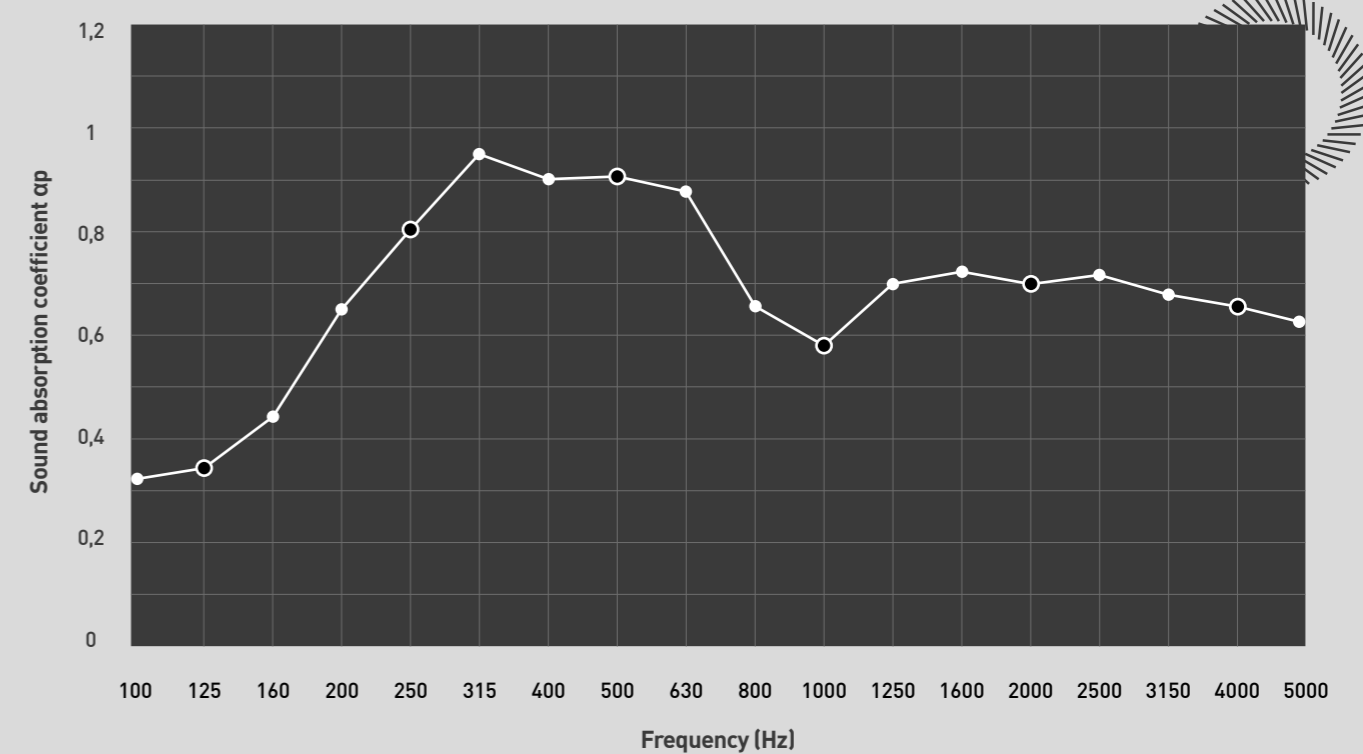

Sound absorption coefficient bei MetallCeilingsystem with proportional perforation type 2516

Evaluation according to ISO 354

Practical sound absorption coefficient according to ISO 11654

$\alpha_w = 0,70$  (L)

Sound absorption class C

Sound acoustic values						
Frequency (Hz)	125	250	500	1000	2000	4000
Terz $\alpha_s$	0,34	0,81	0,91	0,58	0,70	0,66



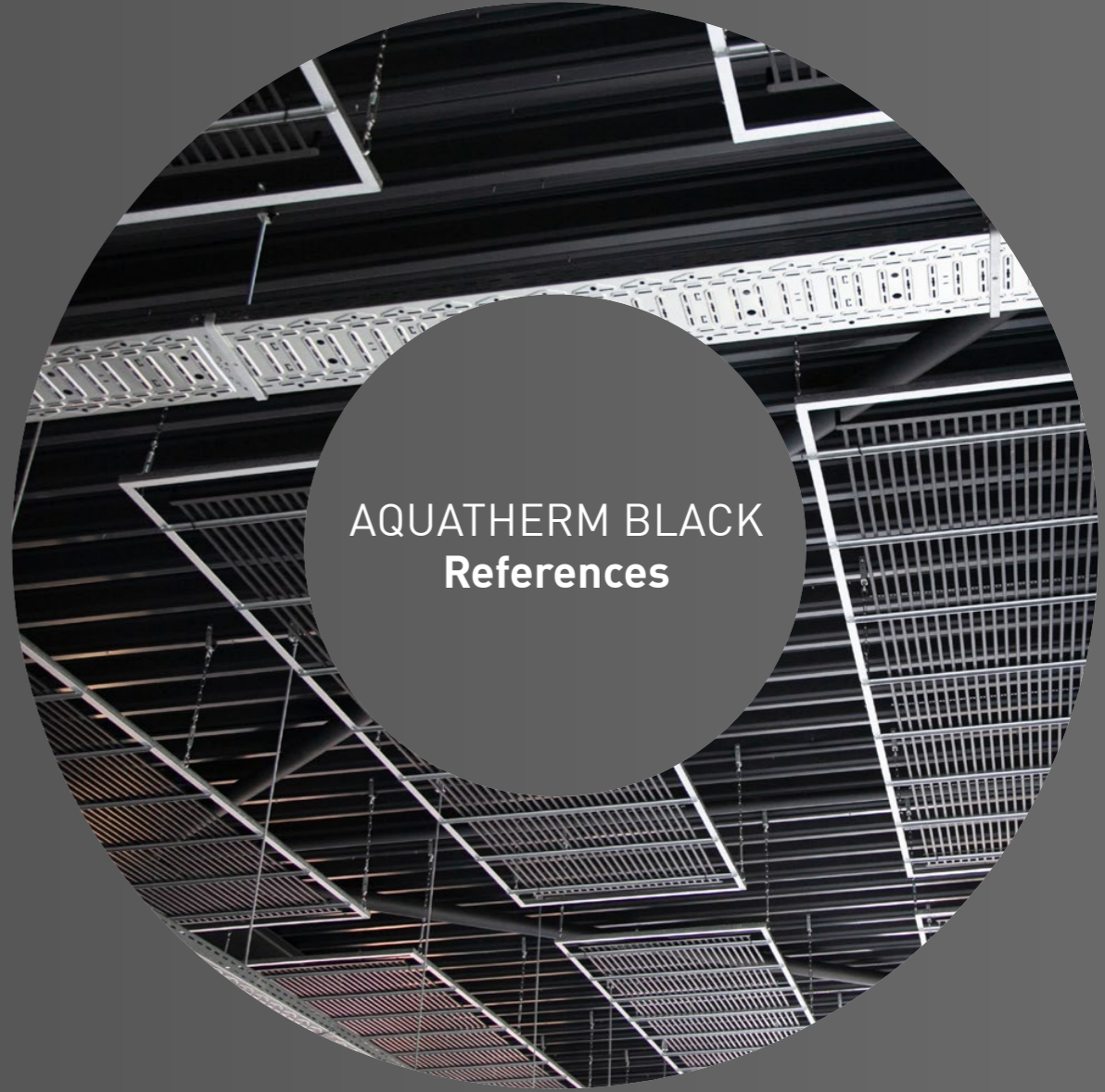

AQUATHERM BLACK  
References





AQUATHERM BLACK references

## Surface heating and cooling

### Project

Luisenhöhe Health Resort

### Location

Horben, Germany

### Completion

2023

### Application

Surface heating and cooling

### The challenge

One challenge in planning the Luisenhöhe heating/cooling ceiling was the architecture of the new building with few right angles. In addition, the material used had to fit into the sustainability concept.

### The solution

aquatherm black surface heating and cooling system made of the sustainable plastic polypropylene could be easily and flexibly adapted to the conditions on site.

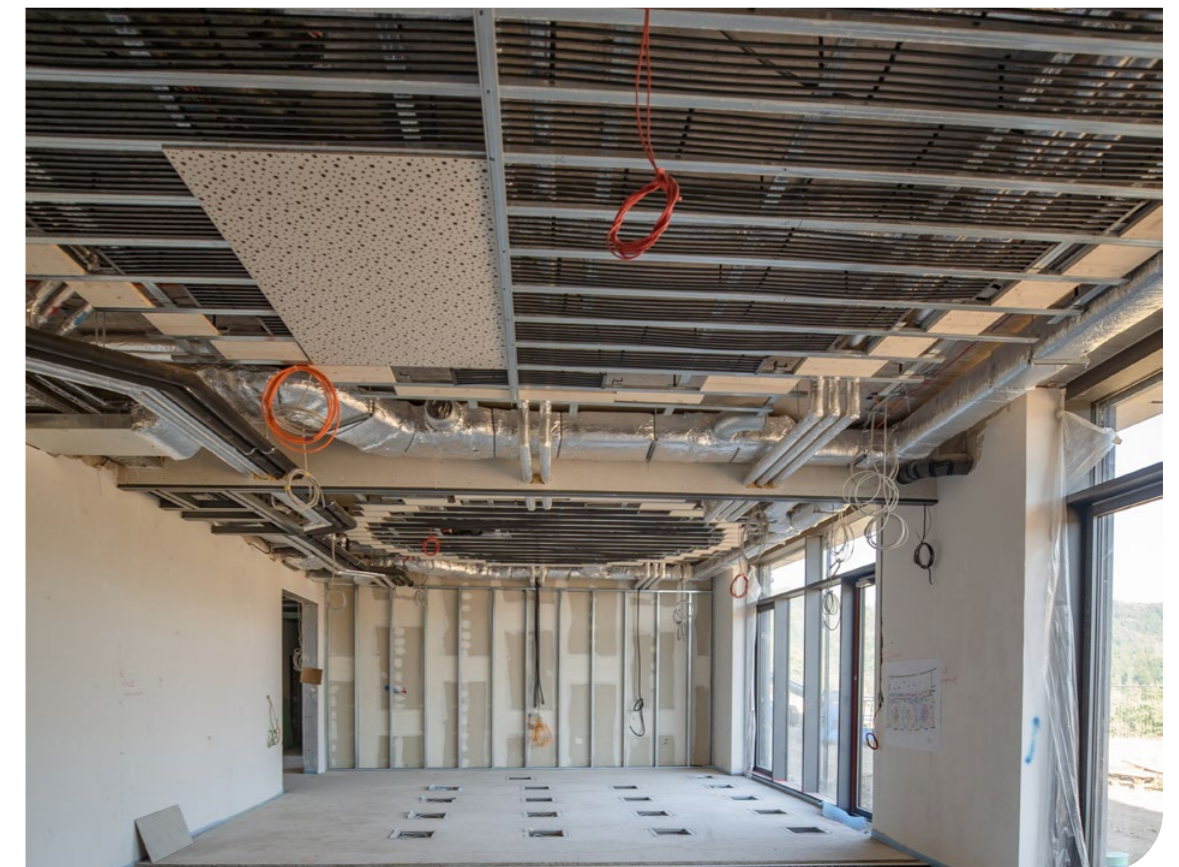





*AQUATHERM BLACK references*

## Surface heating and cooling

**Project**

BayWa-Areal Zwanzig Zwanzig

**Location**

Ludwigsburg, Germany

**Completion**

2020

**Application**

Surface heating and cooling

**The challenge**

For the office building on the "BayWa-Areal Zwanzig Zwanzig" site, the costs for heating and cooling the rooms had to be as low as possible - without sacrificing comfort.

**The solution**

The aquatherm black surface heating and cooling system was installed in a perforated acoustic ceiling. It ensures a pleasant climate and saves energy.





AQUATHERM BLACK references

## Surface heating and cooling

**Project**  
"mikado"

**Location**  
Friedrichshafen, Germany

**Completion**  
2020

**Application**  
Surface heating and cooling

**The challenge**  
For the "mikado" office complex, the clients were looking for a surface heating and cooling system that could be flexibly integrated into the specially developed expanded metal ceiling and optimise the temperature in the rooms.

**The solution**  
The aquatherm black fulfilled the requirements due to the precisely fitting production and scored with an easy installation, an energy-saving operation and a very good controllability.



Photo: mikado







Photo: Schedler KG



AQUATHERM BLACK references

## Surface heating and cooling

### Project

Elements bathroom exhibition

### Location

Lennebstadt, Germany

### Completion

2021

### Application

Surface heating and cooling

### The challenge

To achieve the LEED Gold quality level, the planning team looked for a pipe for its geothermal, cooling water and ice-free systems that was environmentally friendly, durable and had a secure connection technology.

### The solution

To meet these requirements, products from aquatherm were selected after careful testing. Another advantage of aquatherm was that the use of the products made of polypropylene (PP-R) offered a great saving of installation time.



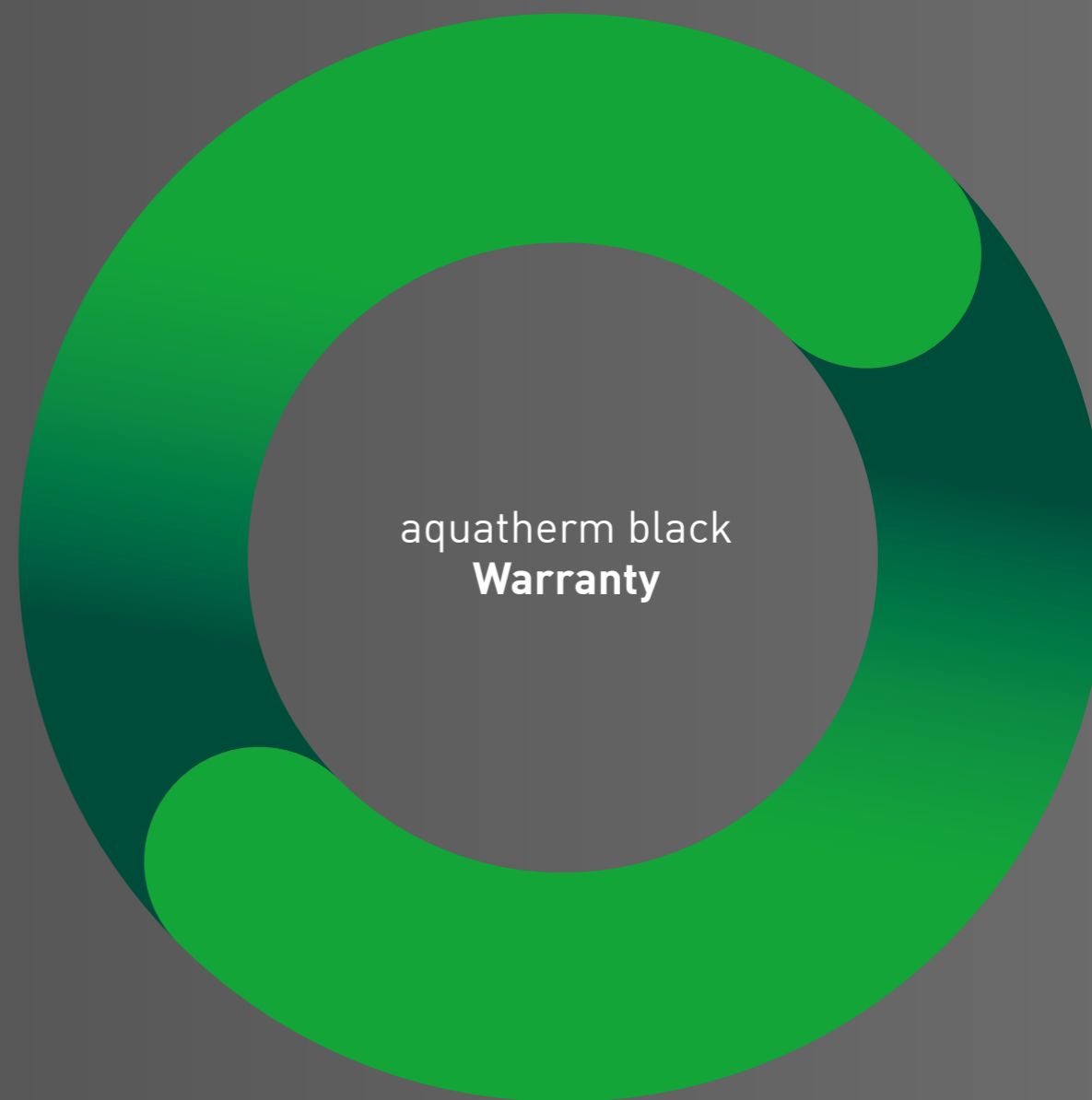
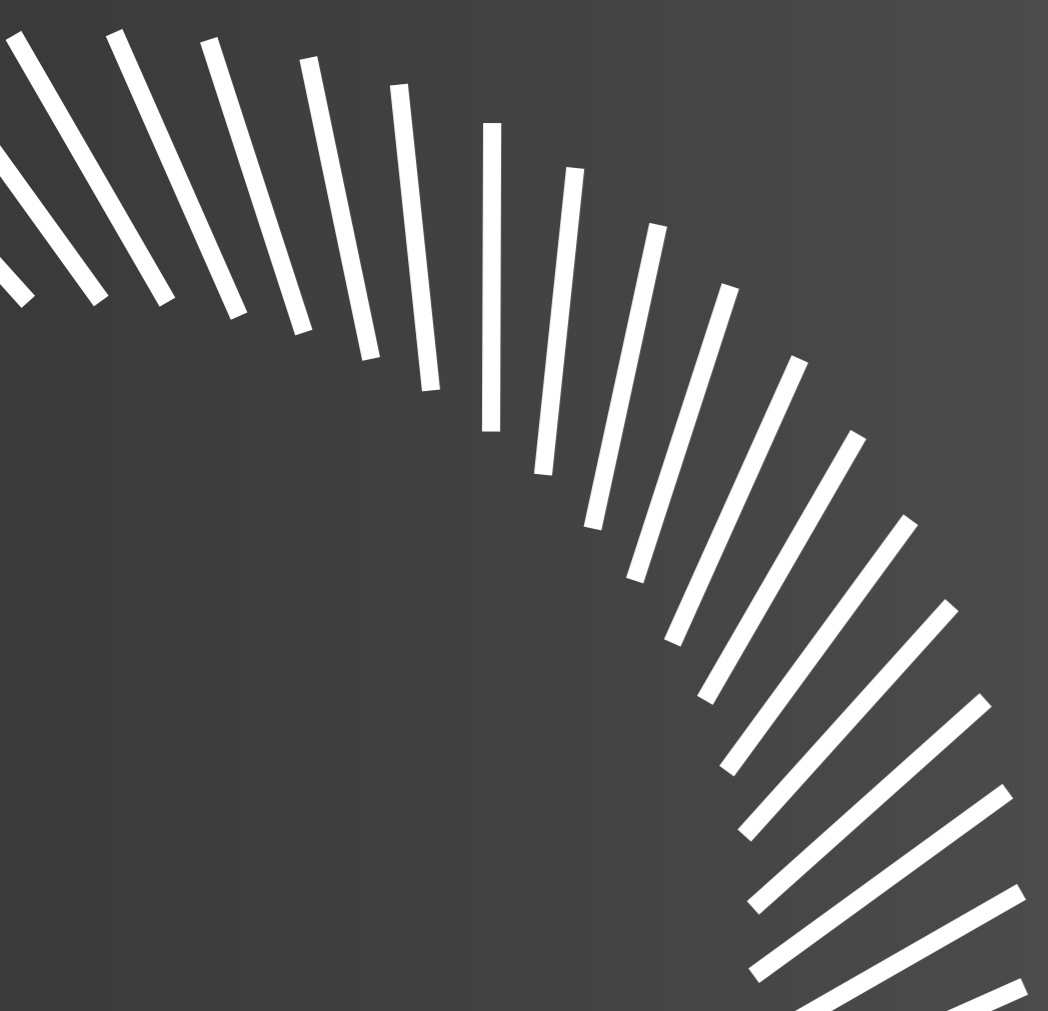

aquatherm black  
**Warranty**





# Explanatory notes on the aquatherm GmbH warranty



## 1. Foreword

Thank you for choosing a product from aquatherm GmbH, Germany. With almost 50 years of experience in the international plastics market and our trend-setting innovations, we have the necessary expertise to offer you customised system solutions "Made in Germany".

Our confidence in the quality of our products has motivated us to offer all pipes and fittings with a 10-year warranty instead of the 2 years required under German law. The extended warranty period is covered by a comprehensive insurance policy from a leading insurance company in our industry. The warranty period begins on the date of delivery by aquatherm GmbH and comes into effect on the date of the successfully performed and documented leak test in accordance with aquatherm specifications.

## 2. Scope of warranty

The aquatherm warranty protects you against financial losses that are demonstrably attributable to material defects, manufacturing errors and/or consulting/construction services provided by aquatherm. The warranty protection applies to the following product groups:

- aquatherm green (fusiotherm und aquatherm ISO)
- aquatherm blue (climatherm und aquatherm ISO)
- aquatherm red (firestop)
- aquatherm black (climasystem)
- aquatherm lilac pipe (aquatherm lilac)
- aquatherm orange system (aquatherm Heating systems)
- aquatherm grey pipe (aquatherm SHT-System)
- Installations carried out by aquatherm from these products

### 2.1 What is covered by the aquatherm warranty?

The aquatherm warranty covers three aspects of damage: property damage, financial loss and personal injury.

#### 2.1.1 What is property damage?

The damage or destruction of an item as a result of a defective product (e.g. classic water damage due to a leak). This impairs the usability of the item to fulfil its actual purpose. The term property damage is used when material assets are damaged or destroyed. Material damage can result in considerable costs, such as renovation, repair or replacement costs.

#### 2.1.2 What is meant by financial loss?

Financial losses can be either additional expenses or a loss of business. Additional expenses are, for example, the costs for the removal and installation of replacement products following damage. Loss of business is the financial disadvantage suffered by the injured party as a result of damage (e.g. loss of income due to renovations following property damage).

#### 2.1.3 What is meant by personal injury?

When a person suffers an injury, this is referred to as personal injury. For the purposes of this document, personal injury cover means the direct medical costs resulting from an injury.

## 3. What is not covered?

The costs incurred in connection with the claims, due to:

- Non-compliance with the terms and conditions specified by aquatherm specified operating parameters (see also technical documents from aquatherm). In case of doubt, please contact aquatherm GmbH or your local aquatherm representative. Exceptions must be made in writing by an aquatherm technician.
- Failure to comply with the instructions in the aquatherm product documentation installation and installation guidelines, in particular with regard to the use of aquatherm pipe clamps or other pipe fastenings compatible/usable with the aquatherm systems.
- Non-compliance with the applicable national installation and laying regulations.
- Connections that do not comply with the aquatherm guidelines including but not limited to: incorrect fusion technique, use of contaminated materials or tools, use of faulty or unsuitable tools or any connection made by an installer without sufficient knowledge of aquatherm connection technology.
- Improperly established connections with other Piping systems and/or components (threads, flanges, brackets, mechanical connections that are not intended for use with aquatherm PP piping systems, etc.).
- All sealing elements used in the product lines manufactured by aquatherm.
- The tools and accessories sold by aquatherm GmbH are subject to the statutory warranty.
- Systems with faulty pipework parts or moulded parts, which have not been subjected to an aquatherm leakage test or another test approved by aquatherm prior to commissioning.
- Damage to our products after the transfer of risk.
- Damage caused or caused by copper in water and result from erosion/corrosion or other degradation of copper components in a pipework system.
- Delays caused by planning errors, delivery problems and/or or incorrect orders.
- Damage caused by entrained air, air pockets, high Pressure fluctuations or cavitation in the pipework system.

**Note:** This list contains only the best-known examples. Other events that affect the integrity of the products can also jeopardise the insurance cover.

## 4. How is the amount of compensation under the aquatherm warranty determined?

In the event of a material failure, aquatherm GmbH will be

provided with samples of the damaged/defective product for inspection. In co-operation with the injured party, aquatherm will determine the cause of the damage and, if necessary, consult external bodies (testing institutes, laboratories, experts). If it is determined that the damage was caused by a material defect and/or manufacturing error or by aquatherm's consulting/construction services, the amount of the claim for damages will be examined and determined. In connection with the claim for damages, it is necessary to prove/document all expenses in a detailed and verifiable form.

## 5. What is the maximum insurance cover?

In the first 5 years of the warranty period, property damage, personal injury and financial loss are covered to the amount of €20 million per insured event. The total cover for all cases in one year is a maximum of €40 million. For years 6-10 of the warranty period, the sums insured are €8.5 million and €17 million respectively. Submit for damage to the planned objects/buildings (planning liability insurance) per insured event €2 million and €6 million for all insured events in the insurance year.

## 6. Why is the cover given in euros?

Both the insured manufacturer, aquatherm, and the insurer are based within the EU, so their agreements are issued in euros. As exchange rates fluctuate, the exchange rate valid at the time of the claim shall apply.

## 7. What is the communication channel for raising a warranty claim and related queries?

Warranty claims must be made directly to aquatherm GmbH or via their respective national representatives. Only the aquatherm partner or aquatherm GmbH will provide information on the processing status of the claim for damages.

## 8. Legal notice

If there is a discrepancy or contradiction between this document and the underlying insurance policy, the latter will always apply.

## 9. Notes on avoiding damage

### I) Production according to certified quality standards

As a reliable manufacturer, aquatherm works according to certified quality standards (ISO 9001); constant internal quality controls are part of the daily routine. In addition, all employees are involved in quality assurance. As a result, products that do not meet our high standards are quickly recognised and removed from our range.

### II) Prevention of damage due to incorrect handling

After delivery from our production plants, our products

must be handled conscientiously and carefully. Experience has shown that most damage occurs during transport, storage and/or processing on site. At this point, we would like to expressly point out that correct handling contributes to maintaining product quality.

### III) Processing by trained installers

Installation errors are easy to avoid! Our training courses teach the correct techniques for working with our products. Particular emphasis is placed on careful and meticulous installation. Installers who have been trained by us or a qualified aquatherm specialist work much more safely and the installation is much more efficient.

**To ensure a secure connection between pipe and fitting, we recommend the exclusive use of aquatherm PP products. Mixing with non-system PP pipes and/or fittings must be avoided.**

February 2023

aquatherm GmbH, Biggen 5, 57439 Attendorn, Germany



aquatherm black  
**Transport & storage**





## AQUATHERM TRANSPORT AND STORAGE

### Careful storage

aquatherm pipes can be stored at any outside temperature. The storage location should generally be selected so that the entire length of the pipes is always in contact with the ground. Avoid bending the pipes during storage and transport.

At sub-zero temperatures, the pipes may be damaged by heavy impacts. The material must therefore be handled with care at these temperatures. Despite their high resistance, aquatherm pipes should

always be treated with care. UV rays have an effect on all high-polymer plastics. Unprotected permanent outdoor storage is therefore not recommended. The maximum permissible outdoor storage period is 6 months.





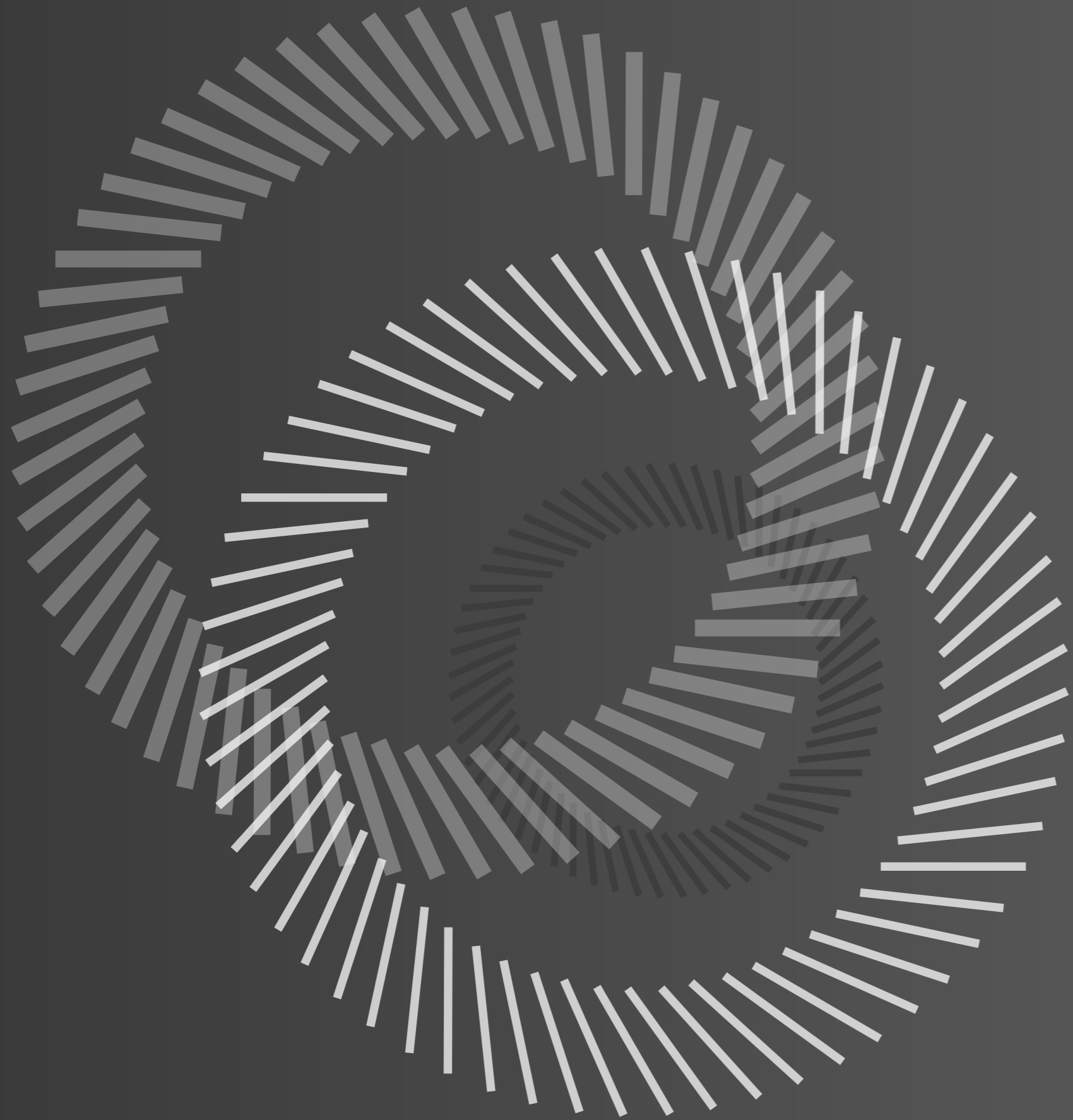

**AQUATHERM BLACK  
Article List**





Connection type 43

**aquatherm black energy grid**

One-sided push-fit connection, 45° left / right

Article no.	Width [m]	Length [m]	Area [m <sup>2</sup> ]	LE	RG
4310240600	0,24	0,60	0,14	1	20
4310240800	0,24	0,80	0,19	1	20
4310241000	0,24	1,00	0,24	1	20
4310241200	0,24	1,20	0,29	1	20
4310241400	0,24	1,40	0,34	1	20
4310241600	0,24	1,60	0,38	1	20
4310241800	0,24	1,80	0,43	1	20
4310242000	0,24	2,00	0,48	1	20
4310280600	0,28	0,60	0,17	1	20
4310280800	0,28	0,80	0,22	1	20
4310281000	0,28	1,00	0,28	1	20
4310281200	0,28	1,20	0,34	1	20
4310281400	0,28	1,40	0,39	1	20
4310281600	0,28	1,60	0,45	1	20
4310281800	0,28	1,80	0,50	1	20
4310282000	0,28	2,00	0,56	1	20
4310320600	0,32	0,60	0,19	1	20
4310320800	0,32	0,80	0,26	1	20
4310321000	0,32	1,00	0,32	1	20
4310321200	0,32	1,20	0,38	1	20
4310321400	0,32	1,40	0,45	1	20
4310321600	0,32	1,60	0,51	1	20
4310321800	0,32	1,80	0,58	1	20
4310322000	0,32	2,00	0,64	1	20
4310360600	0,36	0,60	0,22	1	20
4310360800	0,36	0,80	0,29	1	20
4310361000	0,36	1,00	0,36	1	20
4310361200	0,36	1,20	0,43	1	20
4310361400	0,36	1,40	0,50	1	20
4310361600	0,36	1,60	0,58	1	20
4310361800	0,36	1,80	0,65	1	20
4310362000	0,36	2,00	0,72	1	20
4310400600	0,40	0,60	0,24	1	20
4310400800	0,40	0,80	0,32	1	20
4310401000	0,40	1,00	0,40	1	20
4310401200	0,40	1,20	0,48	1	20
4310401400	0,40	1,40	0,56	1	20
4310401600	0,40	1,60	0,64	1	20
4310401800	0,40	1,80	0,72	1	20
4310402000	0,40	2,00	0,80	1	20
4310480600	0,48	0,60	0,29	1	20
4310480800	0,48	0,80	0,38	1	20

Continued on the next page ...

**aquatherm black energy grid**

One-sided push-fit connection, 45° left / right

Article no.	Width [m]	Length [m]	Area [m <sup>2</sup> ]	LE	RG
4310481000	0,48	1,00	0,48	1	20
4310481200	0,48	1,20	0,58	1	20
4310481400	0,48	1,40	0,67	1	20
4310481600	0,48	1,60	0,77	1	20
4310481800	0,48	1,80	0,86	1	20
4310482000	0,48	2,00	0,96	1	20
4310520600	0,52	0,60	0,31	1	20
4310520800	0,52	0,80	0,42	1	20
4310521000	0,52	1,00	0,52	1	20
4310521200	0,52	1,20	0,62	1	20
4310521400	0,52	1,40	0,73	1	20
4310521600	0,52	1,60	0,83	1	20
4310521800	0,52	1,80	0,94	1	20
4310522000	0,52	2,00	1,04	1	20
4310560600	0,56	0,60	0,34	1	20
4310560800	0,56	0,80	0,45	1	20
4310561000	0,56	1,00	0,56	1	20
4310561200	0,56	1,20	0,67	1	20
4310561400	0,56	1,40	0,78	1	20
4310561600	0,56	1,60	0,90	1	20
4310561800	0,56	1,80	1,01	1	20
4310562000	0,56	2,00	1,12	1	20
4310600600	0,60	0,60	0,36	1	20
4310600800	0,60	0,80	0,48	1	20
4310601000	0,60	1,00	0,60	1	20
4310601200	0,60	1,20	0,72	1	20
4310601400	0,60	1,40	0,84	1	20
4310601600	0,60	1,60	0,96	1	20
4310601800	0,60	1,80	1,08	1	20
4310602000	0,60	2,00	1,20	1	20

**aquatherm black energy grid**

One-sided push-fit connection, 45° left / right

Article no.	Width [m]	Length [m]	Area [m <sup>2</sup> ]	LE	RG
*4310481080	0,48	1,08	0,52	1	20
*4310560580	0,56	0,58	0,32	1	20
*4310561180	0,56	1,18	0,66	1	20



Connection type 43



Connection type 43



Connection type 44

**aquatherm black energy grid**

Alternating push-fit connection, 45° bottom left / top right

Article no.	Width [m]	Length [m]	Area [m <sup>2</sup> ]	LE	RG
4410240600	0,24	0,60	0,14	1	20
4410240800	0,24	0,80	0,19	1	20
4410241000	0,24	1,00	0,24	1	20
4410241200	0,24	1,20	0,29	1	20
4410241400	0,24	1,40	0,34	1	20
4410241600	0,24	1,60	0,38	1	20
4410241800	0,24	1,80	0,43	1	20
4410242000	0,24	2,00	0,48	1	20
4410280600	0,28	0,60	0,17	1	20
4410280800	0,28	0,80	0,22	1	20
4410281000	0,28	1,00	0,28	1	20
4410281200	0,28	1,20	0,34	1	20
4410281400	0,28	1,40	0,39	1	20
4410281600	0,28	1,60	0,45	1	20
4410281800	0,28	1,80	0,50	1	20
4410282000	0,28	2,00	0,56	1	20
4410320600	0,32	0,60	0,19	1	20
4410320800	0,32	0,80	0,26	1	20
4410321000	0,32	1,00	0,32	1	20
4410321200	0,32	1,20	0,38	1	20
4410321400	0,32	1,40	0,45	1	20
4410321600	0,32	1,60	0,51	1	20
4410321800	0,32	1,80	0,58	1	20
4410322000	0,32	2,00	0,64	1	20
4410360600	0,36	0,60	0,22	1	20
4410360800	0,36	0,80	0,29	1	20
4410361000	0,36	1,00	0,36	1	20
4410361200	0,36	1,20	0,43	1	20
4410361400	0,36	1,40	0,50	1	20
4410361600	0,36	1,60	0,58	1	20
4410361800	0,36	1,80	0,65	1	20
4410362000	0,36	2,00	0,72	1	20
4410400600	0,40	0,60	0,24	1	20
4410400800	0,40	0,80	0,32	1	20
4410401000	0,40	1,00	0,40	1	20
4410401200	0,40	1,20	0,48	1	20
4410401400	0,40	1,40	0,56	1	20
4410401600	0,40	1,60	0,64	1	20
4410401800	0,40	1,80	0,72	1	20
4410402000	0,40	2,00	0,80	1	20
4410480600	0,48	0,60	0,29	1	20
4410480800	0,48	0,80	0,38	1	20

Continued on the next page ...

**aquatherm black energy grid**

Alternating push-fit connection, 45° bottom left / top right

Article no.	Width [m]	Length [m]	Area [m <sup>2</sup> ]	LE	RG
4410481000	0,48	1,00	0,48	1	20
4410481200	0,48	1,20	0,58	1	20
4410481400	0,48	1,40	0,67	1	20
4410481600	0,48	1,60	0,77	1	20
4410481800	0,48	1,80	0,86	1	20
4410482000	0,48	2,00	0,96	1	20
4410520600	0,52	0,60	0,31	1	20
4410520800	0,52	0,80	0,42	1	20
4410521000	0,52	1,00	0,52	1	20
4410521200	0,52	1,20	0,62	1	20
4410521400	0,52	1,40	0,73	1	20
4410521600	0,52	1,60	0,83	1	20
4410521800	0,52	1,80	0,94	1	20
4410522000	0,52	2,00	1,04	1	20
4410560600	0,56	0,60	0,34	1	20
4410560800	0,56	0,80	0,45	1	20
4410561000	0,56	1,00	0,56	1	20
4410561200	0,56	1,20	0,67	1	20
4410561400	0,56	1,40	0,78	1	20
4410561600	0,56	1,60	0,90	1	20
4410561800	0,56	1,80	1,01	1	20
4410562000	0,56	2,00	1,12	1	20
4410600600	0,60	0,60	0,36	1	20
4410600800	0,60	0,80	0,48	1	20
4410601000	0,60	1,00	0,60	1	20
4410601200	0,60	1,20	0,72	1	20
4410601400	0,60	1,40	0,84	1	20
4410601600	0,60	1,60	0,96	1	20
4410601800	0,60	1,80	1,08	1	20
4410602000	0,60	2,00	1,20	1	20



Connection type 44





Connection type 46

**aquatherm black energy grid**

One-sided push-fit connection, left / right

Article no.	Width [m]	Length [m]	Area [m <sup>2</sup> ]	LE	RG
4610240600	0,24	0,60	0,14	1	20
4610240800	0,24	0,80	0,19	1	20
4610241000	0,24	1,00	0,24	1	20
4610241200	0,24	1,20	0,29	1	20
4610241400	0,24	1,40	0,34	1	20
4610241600	0,24	1,60	0,38	1	20
4610241800	0,24	1,80	0,43	1	20
4610242000	0,24	2,00	0,48	1	20
4610242250	0,24	2,25	0,54	1	20
4610242500	0,24	2,50	0,60	1	20
4610280600	0,28	0,60	0,17	1	20
4610280800	0,28	0,80	0,22	1	20
4610281000	0,28	1,00	0,28	1	20
4610281200	0,28	1,20	0,34	1	20
4610281400	0,28	1,40	0,39	1	20
4610281600	0,28	1,60	0,45	1	20
4610281800	0,28	1,80	0,50	1	20
4610282000	0,28	2,00	0,56	1	20
4610320600	0,32	0,60	0,19	1	20
4610320800	0,32	0,80	0,26	1	20
4610321000	0,32	1,00	0,32	1	20
4610321200	0,32	1,20	0,38	1	20
4610321400	0,32	1,40	0,45	1	20
4610321600	0,32	1,60	0,51	1	20
4610321800	0,32	1,80	0,58	1	20
4610322000	0,32	2,00	0,64	1	20
4610360600	0,36	0,60	0,22	1	20
4610360800	0,36	0,80	0,29	1	20
4610361000	0,36	1,00	0,36	1	20
4610361200	0,36	1,20	0,43	1	20
4610361400	0,36	1,40	0,50	1	20
4610361600	0,36	1,60	0,58	1	20
4610361800	0,36	1,80	0,65	1	20
4610362000	0,36	2,00	0,72	1	20
4610400600	0,40	0,60	0,24	1	20
4610400800	0,40	0,80	0,32	1	20
4610401000	0,40	1,00	0,40	1	20
4610401200	0,40	1,20	0,48	1	20
4610401400	0,40	1,40	0,56	1	20
4610401600	0,40	1,60	0,64	1	20
4610401800	0,40	1,80	0,72	1	20
4610402000	0,40	2,00	0,80	1	20

Continued on the next page ...

**aquatherm black energy grid**

One-sided push-fit connection, left / right

Article no.	Width [m]	Length [m]	Area [m <sup>2</sup> ]	LE	RG
4610480600	0,48	0,60	0,29	1	20
4610480800	0,48	0,80	0,38	1	20
4610481000	0,48	1,00	0,48	1	20
4610481200	0,48	1,20	0,58	1	20
4610481400	0,48	1,40	0,67	1	20
4610481600	0,48	1,60	0,77	1	20
4610481800	0,48	1,80	0,86	1	20
4610482000	0,48	2,00	0,96	1	20
4610520600	0,52	0,60	0,31	1	20
4610520800	0,52	0,80	0,42	1	20
4610521000	0,52	1,00	0,52	1	20
4610521200	0,52	1,20	0,62	1	20
4610521400	0,52	1,40	0,73	1	20
4610521600	0,52	1,60	0,83	1	20
4610521800	0,52	1,80	0,94	1	20
4610522000	0,52	2,00	1,04	1	20
4610560600	0,56	0,60	0,34	1	20
4610560800	0,56	0,80	0,45	1	20
4610561000	0,56	1,00	0,56	1	20
4610561200	0,56	1,20	0,67	1	20
4610561400	0,56	1,40	0,78	1	20
4610561600	0,56	1,60	0,90	1	20
4610561800	0,56	1,80	1,01	1	20
4610562000	0,56	2,00	1,12	1	20
4610600600	0,60	0,60	0,36	1	20
4610600800	0,60	0,80	0,48	1	20
4610601000	0,60	1,00	0,60	1	20
4610601200	0,60	1,20	0,72	1	20
4610601400	0,60	1,40	0,84	1	20
4610601600	0,60	1,60	0,96	1	20
4610601800	0,60	1,80	1,08	1	20
4610602000	0,60	2,00	1,20	1	20



Connection type 46



Connection type 45

**aquatherm black heating and cooling grid**

One-sided welding connection, left / right

Article no.	Width [m]	Length [m]	Area [m <sup>2</sup> ]	LE	RG
4510240600	0,24	0,60	0,14	1	20
4510240800	0,24	0,80	0,19	1	20
4510241000	0,24	1,00	0,24	1	20
4510241200	0,24	1,20	0,29	1	20
4510241400	0,24	1,40	0,34	1	20
4510241600	0,24	1,60	0,38	1	20
4510241800	0,24	1,80	0,43	1	20
4510242000	0,24	2,00	0,48	1	20
4510280600	0,28	0,60	0,17	1	20
4510280800	0,28	0,80	0,22	1	20
4510281000	0,28	1,00	0,28	1	20
4510281200	0,28	1,20	0,34	1	20
4510281400	0,28	1,40	0,39	1	20
4510281600	0,28	1,60	0,45	1	20
4510281800	0,28	1,80	0,50	1	20
4510282000	0,28	2,00	0,56	1	20
4510320600	0,32	0,60	0,19	1	20
4510320800	0,32	0,80	0,26	1	20
4510321000	0,32	1,00	0,32	1	20
4510321200	0,32	1,20	0,38	1	20
4510321400	0,32	1,40	0,45	1	20
4510321600	0,32	1,60	0,51	1	20
4510321800	0,32	1,80	0,58	1	20
4510322000	0,32	2,00	0,64	1	20
4510360600	0,36	0,60	0,22	1	20
4510360800	0,36	0,80	0,29	1	20
4510361000	0,36	1,00	0,36	1	20
4510361200	0,36	1,20	0,43	1	20
4510361400	0,36	1,40	0,50	1	20
4510361600	0,36	1,60	0,58	1	20
4510361800	0,36	1,80	0,65	1	20
4510362000	0,36	2,00	0,72	1	20
4510400600	0,40	0,60	0,24	1	20
4510400800	0,40	0,80	0,32	1	20
4510401000	0,40	1,00	0,40	1	20
4510401200	0,40	1,20	0,48	1	20
4510401400	0,40	1,40	0,56	1	20
4510401600	0,40	1,60	0,64	1	20
4510401800	0,40	1,80	0,72	1	20
4510402000	0,40	2,00	0,80	1	20
4510480600	0,48	0,60	0,29	1	20
4510480800	0,48	0,80	0,38	1	20

Continued on the next page ...

**aquatherm black heating and cooling grid**

One-sided welding connection, left / right

Article no.	Width [m]	Length [m]	Area [m <sup>2</sup> ]	LE	RG
4510481000	0,48	1,00	0,48	1	20
4510481200	0,48	1,20	0,58	1	20
4510481400	0,48	1,40	0,67	1	20
4510481600	0,48	1,60	0,77	1	20
4510481800	0,48	1,80	0,86	1	20
4510482000	0,48	2,00	0,96	1	20
4510520600	0,52	0,60	0,31	1	20
4510520800	0,52	0,80	0,42	1	20
4510521000	0,52	1,00	0,52	1	20
4510521200	0,52	1,20	0,62	1	20
4510521400	0,52	1,40	0,73	1	20
4510521600	0,52	1,60	0,83	1	20
4510521800	0,52	1,80	0,94	1	20
4510522000	0,52	2,00	1,04	1	20
4510560600	0,56	0,60	0,34	1	20
4510560800	0,56	0,80	0,45	1	20
4510561000	0,56	1,00	0,56	1	20
4510561200	0,56	1,20	0,67	1	20
4510561400	0,56	1,40	0,78	1	20
4510561600	0,56	1,60	0,90	1	20
4510561800	0,56	1,80	1,01	1	20
4510562000	0,56	2,00	1,12	1	20
4510600600	0,60	0,60	0,36	1	20
4510600800	0,60	0,80	0,48	1	20
4510601000	0,60	1,00	0,60	1	20
4510601200	0,60	1,20	0,72	1	20
4510601400	0,60	1,40	0,84	1	20
4510601600	0,60	1,60	0,96	1	20
4510601800	0,60	1,80	1,08	1	20
4510602000	0,60	2,00	1,20	1	20



Connection type 45



**aquatherm black Flexible connection pipe**

oxygen-tight, in a ring

Article no.	Dimension	LE	RG
4110020001	20 mm	50	20

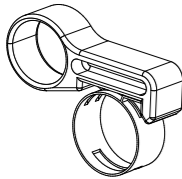
**aquatherm black Spring band clamps**

Article no.	Dimension	LE	RG
9600081074	20 mm	20	20

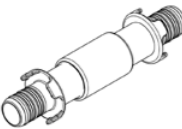
**aquatherm black twin nipple**

for Flexible connecting pipe

Article no.	Dimension	LE	RG
4040016002	16 mm	5	20

**aquatherm black angle 90°**

for Flexible connecting pipe

Article no.	Dimension	LE	RG
4080016002	16 mm	10	20

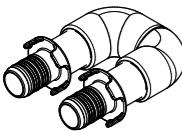
**aquatherm black angle 180°**

Article no.	Dimension	LE	RG
4090016008	16 mm	10	20

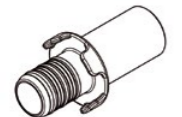
**aquatherm black transition piece**

Article no.	Dimension	LE	RG
4070016002	16 mm	10	20

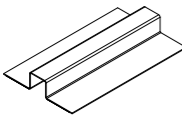
**aquatherm black heat conduction module**

Article no.	Dimension	LE	RG
9700081284	Length: 10 cm	200	20

**aquatherm black distributor**

Article no.	Execution	LE	RG
9700094602	Plastic 2-fold	1	20
9700094603	Plastic 3-fold	1	20
9700094604	Plastic 4-fold	1	20
9700094605	Plastic 5-fold	1	20
9700094606	Plastic 6-fold	1	20

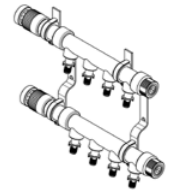

Plastic heating circuit manifold with the following properties:

- Flow and return manifolds arranged separately
- Flow indicator, can be shut off in the flow
- Regulating and shut-off valve with protective cap in the return
- Vent valves
- Bracket set with bracket and sound insulation insert
- End plugs

Compression fittings and ball valve set must be ordered separately

Accessories:

- Filling and draining taps

**aquatherm black heating circuit manifold with flow indicator**

Article no.	Dimension	LE	RG
9700094502	Stainless steel 2-gang DFM	1	20
9700094503	Stainless steel 3-fold DFM	1	20
9700094504	Stainless steel 4-fold DFM	1	20
9700094505	Stainless steel 5-way DFM	1	20
9700094506	Stainless steel 6-way DFM	1	20
9700094507	Stainless steel 7-way DFM	1	20
9700094508	Stainless steel 8-way DFM	1	20
9700094509	Stainless steel 9-way DFM	1	20
9700094510	Stainless steel 10-fold DFM	1	20
9700094511	Stainless steel 11-fold DFM	1	20
9700094512	Stainless steel 12-way DFM	1	20

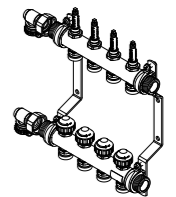

Stainless steel heating circuit manifold with the following features:

- Flow and return manifold arranged separately
- Flow indicator, can be shut off in the flow
- Regulating and shut-off valve with protective cap in the return flow
- Filling and drain taps
- Vent valves
- Bracket set with bracket and sound insulation insert
- End plugs

Compression fittings and ball valve set must be ordered separately

**aquatherm black ball valve set**

Article no.	Dimension	LE	RG
9700094513	1 1/4 "OD x 1 "IT	1	2

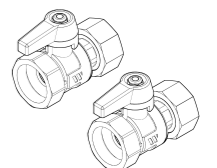

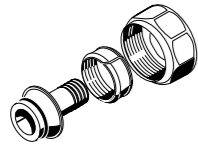
**aquatherm black compression fitting**

Material: brass

with Eurocone for heating circuit manifolds

Article no.	Dimension	LE	RG
9600092106	16 x 2.0 mm	2	2
9600092108	20 x 2.0 mm	10	2

nickel-plated union nut

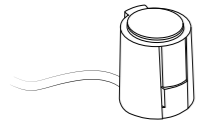
**aquatherm black valve drive**

for heating circuit manifolds

Article no.	Dimension	LE	RG
9700094102	230V	1	2
9700094103	24V	1	2

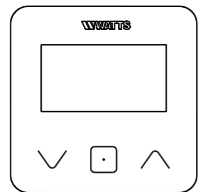
when using the radio control distributor  
(art. no. 94422), take the 230 V switching capacity into account!**aquatherm black wireless room thermostat**

with glass touchscreen

Article no.	LE	RG
9700094418	1	2

- Heating (recommended) or heating/cooling
- Setting different temperature modes
- Frost protection function
- Pin code and theft protection
- Wall mounting or table-top installation
- "Window open" detection

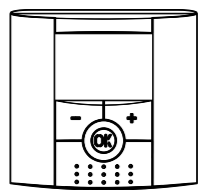
**aquatherm black wireless room thermostat**

digital, with LCD display, programmable

Article no.	LE	RG
9700094419	1	2
9700094420	1	2

\* With hygrostat for heating/cooling, in conjunction with external sensor

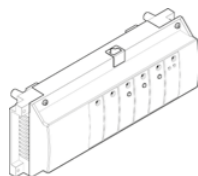
**aquatherm black 6-way radio control distributor**

Master, for 6 zones

Article no.	LE	RG
9700094422	1	2

- Zone control of water-bearing panel heating/cooling systems
- Up to 10 zones (room sensors)
- Switching output for pump and heat generator via radio or cable (potential-free)
- For switching 230 V actuators

**aquatherm black 4-way radio control distributor**

Extension for 4 zones

Article no.	LE	RG
9700094423	1	2

- For switching 230 V actuators

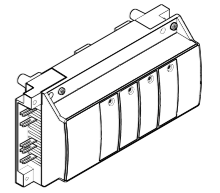
**aquatherm black Management module**

for heating/cooling

Article no.	LE	RG
9700094421	1	2

- Control and management of water-bearing surface heating/cooling systems in conjunction with control distributor
- Signal for centralised heating/cooling switchover via potential-free switching output

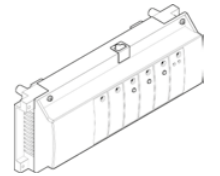
**aquatherm black single radio receiver**

for control of surface heating/cooling systems

Article no.	LE	RG
9700094424	1	2

- Control of electric actuators, zone valves, radiators, etc.
- Control via radio room thermostat or directly via the central radio unit

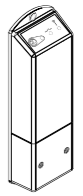
**aquatherm black Funk-Repeater**

to extend the radio transmission range

Article no.	LE	RG
9700094425	1	2

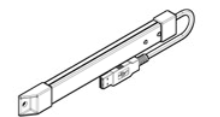
**aquatherm black external sensor/floor sensor**

3m Cable

Article no.	LE	RG
9700094426	1	2

Use in conjunction with wireless room thermostat (with hygrostat) for dew point monitoring

Note: The external sensor must be connected to the cooling/heating surface via cable as early as the shell installation stage, !

**aquatherm black mounting rail**

for heating and cooling grids

Article no.	Dimension	LE	RG
4090016007	Length: 24 cm	10	20

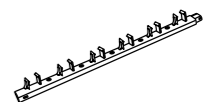



**aquatherm black Mounting**

for heating and cooling grids (for wall heating and cooling systems for drywall construction)

Article no.	LE	RG
4090000001	10	20

**aquatherm black mounting rail for drywall construction**

for heating and cooling grids

Article no.	LE	RG
4090000002	10	20

When ordering the fixing rail for drywall construction, please note that two connecting plugs, art. no.: 4090000003, are also ordered for each rail.

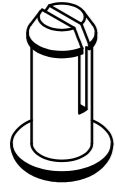
**aquatherm black connection plug**

Article no.	LE	RG
4090000003	1	20

In conjunction with art. no.: 4090000001 for fixing the heating and cooling grids in ceiling systems with metal substructure in conjunction with art. no.: 9700081291 (perforated tape) for fixing the heating and cooling grids in wall systems with metal substructure.

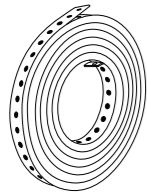
**aquatherm black perforated strip**

Article no.	Dimension	LE	RG
9700081304	10 m x 19 mm	1	20

In conjunction with art. no. 4090000003 for fixing the heating and cooling grids in wall systems with metal substructure.

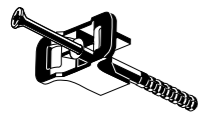
**aquatherm black fixing element with dowel**

for wall and ceiling mounting

Article no.	LE	RG
4050000013	10	20

**aquatherm black thermography film**

is placed on the wall to indicate the position of the pipes by changing colour

Article no.	Dimension	LE	RG
9700050186	150 x 70 mm	1	20

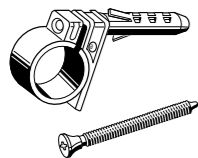
**aquatherm black plastic fastening clamps**

Colour: anthracite

Article no.	Dimension	LE	RG
4090016006	16 mm	50	20
4090020008	20 mm	50	20

**aquatherm black PP-Register pipe**

oxygen-tight

Article no.	Dimension	LE	RG
4110016003	16 x 2.0 mm Length 4 m	100	20
4110020006	20 x 2.0 mm Length 2.5 m	50	20

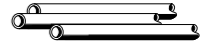
**aquatherm black PP-Register pipe**

oxygen-tight, in a ring

Article no.	Dimension	LE	RG
4110016403	16 x 2.0 mm	100	20
4110020306	20 x 2.0 mm	100	20

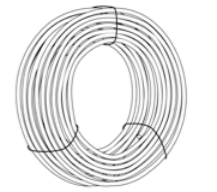
**aquatherm black socket**

for heating and cooling grids

Article no.	Dimension	LE	RG
4040016000	16 mm	10	20

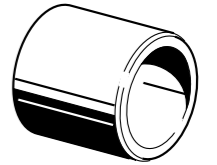
**aquatherm black angel 90° inside/inside**

for heating and cooling grids

Article no.	Dimension	LE	RG
4080016000	16 mm	10	20

**aquatherm black angel 90° inside/outside**

Article no.	Dimension	LE	RG
4080016001	16 mm	10	20

**aquatherm black endcap**

for heating and cooling grids

Article no.	Dimension	LE	RG
4020016000	16 mm	10	20

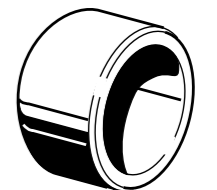
**aquatherm black spacer**

for prefabricated ceilings

Article no.	LE	RG
4090000004	50	20

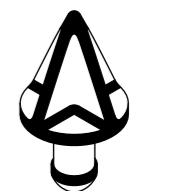

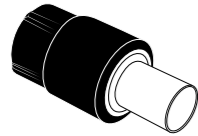
**aquatherm black transition adapter**

e.g. for connecting existing metal pipework

Article no.	Dimension	LE	RG
4070016000	16 mm x 15 mm Press connection	10	20

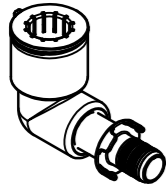
**aquatherm black angle bracket**

for Flexible connecting pipe

Article no.	Dimension	LE	RG
4070016001	16 mm	10	20

\* only available as a spare part

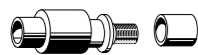
**aquatherm black transition adapter**

The adapter can be connected to the aquatherm orange system using the familiar sliding sleeve technology.

Article no.	Dimension	LE	RG
4050016012	transition from aquatherm black to aquatherm orange system 16 mm	10	20

**aquatherm black KFE-Valve**

Article no.	LE	RG
9700001677	1	20

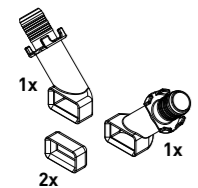
**aquatherm black connection set**

for connection 43

Article no.	LE	RG
9700081118	1	20

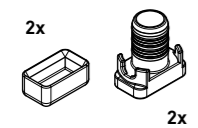
**aquatherm black connection set**

for connection 46

Article no.	LE	RG
9700081117	1	20

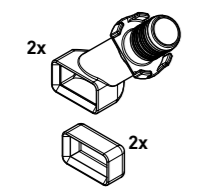
**aquatherm black connection set**

for connection 44

Article no.	LE	RG
9700081116	1	20

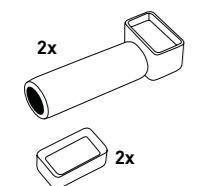
**aquatherm black connection set**

for connection 62 + 59 + 52 + 51

2x end cap, 2x 90° push-fit connection

Article no.	LE	RG
9700081112	1	20

**aquatherm black connection set**

for connection 64 + 45

2x end cap, 2x welding socket

Article no.	LE	RG
9700081114	1	20

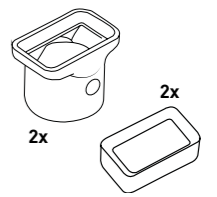
**aquatherm black connection set**

for connection 50 order 2x set + (65)

2x end cap, 1x welding socket, 1x welding spigot

Article no.	LE	RG
9700081115	1	20

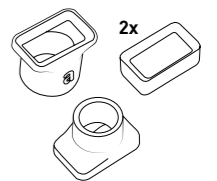
**aquatherm black welding tool**

Article no.	Dimension	LE	RG
9800050285	Welding tool 12x12mm	1	3

For sealing plugs art. no. 4090012005

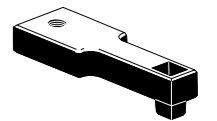
**aquatherm black welding tool**

Article no.	Dimension	LE	RG
9800050283	14x24mm	1	3

**aquatherm black sealing plug**

for wall and ceiling grids

Article no.	Dimension	LE	RG
4090012005	12 mm	10	20

Welding tool for sealing plugs Art. no. 9800050285

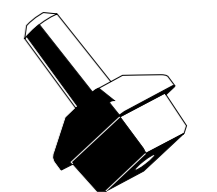
**aquatherm black pipe holder**

Material: PA

Article no.	Dimension	LE	RG
5090000000	for pipes 14-20 mm Tackfix	500	2

For aquatherm black underfloor heating pipes

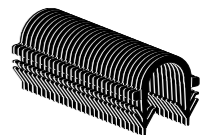
**aquatherm black Stapler**

Article no.	LE	RG
9800096003	1	3

Note: For use with art. no. 5090000000

For fastening the heating pipe to the aquatherm black system elements using pipe holders







**aquatherm GmbH**

Biggen 5 | 57439 Attendorn | Germany  
Tel: +49 2722 950 0 | Mail: [info@aquatherm.de](mailto:info@aquatherm.de)

Status: 11.2024



Part of theSolution  
[www.aquatherm.de](http://www.aquatherm.de)