

aquatherm®



Systems for old and new buildings, industry, open spaces, sport floors and ice rinks

## Surface heating- and cooling systems



**aquatherm**



# **Preface**



# Preface

Dear customers...

...since ancient times, mankind has been thinking of effective ways of transporting and using "aqua" (lat. for water) and "therm" (lat. for warmth).

Applied technologies have been developed and changed considerably over the ages, but the motivation has remained the same: Hygiene, health and well-being.

aquatherm has participated in this development over the past 34 years and in some areas has been able to make decisive contributions. An example is the fusiotherm®-system produced by aquatherm.

And the material fusiolen® PP-R (80) made by aquatherm is the first pipe material which is approved by the world-wide known environmental organization Greenpeace to mark with the logo "Product approved by Greenpeace".

By constantly adapting its products to the needs of the market and developing the relevant know-how, aquatherm has achieved worldwide success and prestige within the last 34 years: a fact which we are proud of, but at the same time giving us the motivation to continue making constant improvements.

This documentation is to give you a first idea of our products and services - and to make you curious to gain more information.

In case of further questions and of course also suggestions, we will be pleased to be at your disposal!

**Gerhard Rosenberg**

Founder and Manager of **aquatherm** GmbH



- 1973**  
Founding of aquatherm by Gerhard Rosenberg
- 1978**  
Transfer to the first factory in Biggen / D-Attendorf
- 1985**  
Completion of factory 1 in Biggen / D-Attendorf
- 1992**  
Founding of the branch in Radeberg near D-Dresden
- 1996**  
Founding of the metal processing company aquatherm metal, D-Attendorf
- 1998**  
Founding of a subsidiary in Carrara / Italy
- 1999**  
Completion of the main site in D-Attendorf as one complex (Factories 1+2, Production and Store, Laboratory and Training Centre)
- 2001**  
Completion of the extension Factory 2 in D-Attendorf
- 2001**  
Opening of the new training centre in D-Radeberg
- 2002**  
Completion of the logistics centre in D-Attendorf
- 2003**  
Completion of rebuilding and finishing of the training centre in D-Attendorf
- 2003**  
30 year celebration of the company aquatherm
- 2005**  
Adding of 2 storeys on the administration building
- 2005/06**  
Completion of the 4-storey hall on the premises in Attendorf
- Basement:** Store
- Ground floor:** Assembly/Packing
- 1st Floor:** Laboratory and Technical department
- 2nd Floor:** Special manifold construction

## Company profile

Certified according to DIN/ISO 9001 aquatherm is a worldwide successful manufacturer of plastic pipe systems for potable water application, climate technology and for the heating sector:

aquatherm was founded 1973 for the development, production and installation of hot-water underfloor heating. At that time aquatherm was one of the three first suppliers of underfloor heating on the European market.

In 1980 aquatherm developed the plastic pipe system fusiotherm® from polypropylene (PP-R (80)) for potable water and heating installations. Up to now this innovation is the foundation stone for a steady growth.

Presently aquatherm is located at 3 sites in Germany totally covering more than 72.000 square metres for offices, production and warehouse:

1. aquatherm main site D-Attendorn (Biggen)
2. aquatherm branch D-Radeberg near D-Dresden
3. aquatherm-metall D-Attendorn (Ennest)

The total workforce at all sites numbers over 460. Each day well over 150 kilometres of pipe and 230.000 fittings are produced, stored and dispatched.

Today, aquatherm is a globally active company, present in 74 of the world, undisputed market leader in many fields and last but not least a flexible medium-sized company, which is able to compete with large corporations.



1



2



3

# Service



Field staff / Infomobil

In addition to the regular training service at Attendorf and Radeberg aquatherm field staff are available to assist customers, on site, throughout Germany.



Laboratory

The aquatherm laboratory: from the testing of granulate through to the finished product the customer can be assured of only the highest quality products.



Training service

In addition to training service through the merchant network aquatherm offers its customers training, free of charge, at its training centres at Attendorf and Radeberg.



Software service

The aquatherm-software service provides Datanorm-files, an independent graphical program (liNear), and the appropriate training.



Fair

aquatherm is represented on all important fairs relevant for the sanitary and heating sector in Germany or abroad with its own exhibition booth. For more information regarding fairs near to you, please call +49-2722-950425 or visit internet page: [www.aquatherm.de](http://www.aquatherm.de).



Miscellaneous

Different aquatherm-CD's, prospects, catalogues, poster, leaflets, mailings, calendars, a.s.m. are investigated and produced from the internal advertising department. All information regarding the company, the technology, the products, the various trainings and fairs as well as all catalogues in pdf-form can be called and downloaded from the aquatherm-website: [www.aquatherm.de](http://www.aquatherm.de).

- Preface	5
- Company profile	6
- Service	7
- Contents	8-9
- Survey of systems	10-11

## Chapter 1:

### System element "heating pipe" 13

- General description	14
- PE-RT pipe	15-16
- PB pipe	17-18
- Surface heating pipes made of multi-layer metal composite pipe	19
- climasystem: Connection pipes for climasystem heating and cooling grids	20

## Chapter 2:

### Manifold technique 23

- aquatherm®-Heating circuit manifold with flow meter	24
- aquatherm®-Heating circuit manifold "object" without flow meter	25
- Heating circuit manifold valves	26
- Accessories for manifold	27-28
- Manifold cabinet "concealed"	29-31
- Manifold cabinet "surface"	32
- Pump module	33
- Distribution technique	34-36
- aquatherm®-Manifold for wide surfaces	37
- aquatherm®-Reverse return technique for industrial floor heating	38
- aquatherm®-Reverse return technique for sports floor heating	39

## Chapter 3:

### Automatic control 41

- Requirements	42
- Actuator	43
- Room thermostat/programmable analogue room thermostat (230 Volt)	44
- Connection system (230 Volt)	45
- Control module and actuator (230 Volt)	46
- Timer module and pump module (230 Volt)	47
- Connection system wireless (24 Volt)	48-49
- Pump module wireless (24 Volt)	50
- Connection system (230 Volt)	51
- Room thermostat NRT 210/220	52
- Connection system (24 Volt)	53
- Control module and actuator module (24 Volt)	54
- Timer module and pump module (24 Volt)	55
- Heating/cooling module (24 Volt) and room thermostat AR 4010 K (24 Volt)	56
- Room thermostat (24 Volt)	57
- Zone control: edge/straight	58
- Mixing control unit	59

- Control unit, analogue	60
- Control unit, digital	61

## Chapter 4:

### Floor construction for house building 63

- DIN-regulations	64
- Conditions for installation	65
- Exceptions	66
- Effects of DIN-regulations	67
- Examples of design	68
- Impact sound insulation	69-70
- Improvement of impact sound insulation	71
- <b>System element valufix roll 35-3</b>	72
- Floor details valufix roll 35-3	73-74
- <b>System element valutherm-aluminium grid foil</b>	75
- Floor details valutherm-aluminium grid foil	76-77
- Accessories for valufix and valutherm-system	78-79
- <b>System element knob plate F ND 35-3</b>	80
- Floor details knob plate F ND 35-3	81-82
- <b>System element knob plate F ND 11</b>	83
- Floor details knob plate F ND 11	84-86
- <b>System element TS 30</b>	87
- Floor details system element TS 30	88-89
- Additional insulating material	90
- Edge insulation	91
- Expansion joint section	92-93
- Screeds	94
- Screed additive floor mix	95
- Special floor mix	96-97
- Screed measuring point	98
- Screed fields/edge gaps	99
- Movement joints/dummy joints	100
- Floor reinforcement/procedures of floor coverings	101
- Floor coverings/conditions for placing	102
- Heating of screed / moisture content equilibrium	103
- Starting record	104

## Chapter 5:

### Heating and cooling systems for wall and ceiling 105

- <b>climasystem</b>	
- Heating and cooling with climasystem	108
- System review	109
- Advantages	110
- Material	111
- Technical data (pipes and grids)	112
- Connection method: fusion	113-115
- Heating- and cooling grids	116
- Connection method: push-fit connection	117-118
- System technique aquatherm-climasystem	119
- Principle of heating and cooling: wall/ceiling	120
- Visual performance ceiling/heating	121
- Visual performance ceiling/cooling	122
- Visual performance wall/heating	123
- Visual performance wall/cooling	124



- Surface temperature	125
- Surface considerations	
- Conduits and cables	
- Expansion joints	
- Plaster and thermal layer	
- Surface finishes	
- Design wall and ceiling heating systems	126
- Wet construction	
- Dry construction	
- Heat control methods "heating"	127-131
- aquatherm-control options	
- aquatherm-control technique	
- "Parallel connection"	
- "Serial connection"	
- "Combination of parallel and serial connection"	
- "Connection of smaller heating surfaces"	
- Heating & cooling: control method	132
- Generals	
- Principle pattern of double pipe arrangement	
- Planning and design "heating/cooling"	133
- Calculation	
- Graphs	
- Standards and guidelines	
- Assembly and starting	134-135
- Wall grid installation wet/dry	136

**Chapter 6:**

**Wide area application 139**

- <b>Sports floor</b>	
- Floor construction	
- Spot flexible sports floor	140
- Surface flexible sports floor	141
(double swing floor design A: tackertechnique with pipe clamps)	
- Surface flexible sports floor	142
(double swing floor design B: pipe guiding rail)	
- Surface flexible sports floor	143
(assembled flooring)	
- Combined flexible sports floor	144
(assembled flooring)	
- <b>Industrial surface heating</b>	
- Thermal insulation	145
for industrial surface heating	
- Floor coverings	146
- Construction models	147
- Regulations, requirements	148
- <b>Open space heating</b>	
- Design	149
- <b>Undersoil heating</b>	
- Design/laying	150
- Construction	151
- <b>Ice surface cooling</b>	
- Design/laying	152

**Chapter 7:**

**Planning and design 155**

- Regulations/decrees/laws	156
- Calculation	157-158
- Floor surface coverings/symbols/rugs	159
- Heating circuit lengths/ manifold connection area	160
- Thermal output acc. to DIN EN 1264	161
- Thermal flow temperature DIN CERTCO registration	162
- Pressure loss graphs	163
- Graph of heat output (PS 50 mm)	164
- Graph of heat output (PS 75 mm)	165
- Graph of heat output (PS 100 mm)	166
- Graph of heat output (PS 150 mm)	167
- Graph of heat output (PS 200 mm)	168
- Graph of heat output (PS 250 mm)	169
- Graph of heat output (PS 300 mm)	170
- Fine control valves	171
- Membrane expansion vessel	172
- Types of placing	173
- Examples of placing: pipe spacing	174
- <b>climasystem</b>	
Planning and design "Graphs"	175-178
- Graph of heat output (plaster, metal, plaster board)	
- Graph of cooling capacity (plaster, metal, plaster board, mineral)	
- Graph of pressure drop	
- Maximum surface per each cooling and heating circuit	
- Laying of system element TS 30	179
- Laying example	180
- Graphs of heat output TS 30	181-182
- Graphs of heat output industrial floor heating	183-185

**Chapter 8: References 187**

- References and photos of all systems	188-197
--	---------

**Index A-Z 199-202**

## New buildings - surface heating



More than three decades experience in the production and application of underfloor heating systems as well as the continuous development to achieve energy saving and efficient technology, make aquatherm one of the most experienced and globally successful manufacturers of underfloor heating.

The performance of an underfloor heating system is mainly determined by the quality of the installed components:

- insulation
  - valufix roll
  - valutherm grid marked sheet
  - knob plate
  - element TS 30
- heating pipe
  - PE-RT pipe
  - PB pipe
  - multi-layer metal composite pipe
  - PP- grid pipes
- manifold technology
- control technique

## Old buildings - surface heating



With the development of the system element TS 30 aquatherm offers an all-purpose heating system for lowest construction thickness in the field of surface heating. It meets all requirements of old and new buildings – especially for refurbishments. Whether in dry or wet construction, all requirements of an underfloor heating system can be complied with. The extruded system plate with pre-fabricated pipe channels is suitable for every floor plan and each room layout.

### Advantages

Lowest construction depth (e.g. 55 mm with dry floor; 60 mm with screed, 65 mm with floating floor) due to low plate thickness. The aquatherm system element 30 is the ideal solution for all situations of laying. Interruptions in the progress of construction work is avoided.

## Heating and cooling for wall



Incorrect controlled room temperature, noise interference or draught are responsible for inefficient room conditions and therefore unsatisfactory performances. In offices, commercial premises, meeting rooms, etc., aquatherm pipe grids have become increasingly more popular for heating and cooling of ceiling and walls. The ingenious aquatherm climasystem delivers pleasant room conditions without forced air movement. With this technology cooling or heating is simply controllable.

Automatic designed change-over of heated or chilled water completes this system – allowing for individual room control within a building management system.

Depending on their design, the pipe grids are connected by means of thermal welding or by pushfit couplings and connected to the cooling- and heating water circulations.

## Heating and cooling for ceiling



The systems of heating and cooling with pipe grids is also suitable for the ceiling installation. Thus, the aquatherm-climasystem can be installed in suspended ceilings on metal ceiling panels or dry-lined panels from gypsum. The embedding into the ceiling plaster is problem-free. Due to the low weight of about 2.5 kg / m<sup>2</sup> (incl. filling) there are no problems with the installation and later starting of the system.

Sports floor heating system



Sportspersons need an action-orientated environment! The right sports floor and an invisible heating system provides the essential comfortable feeling to take exercise at its best. Sports floor heating systems save space and do not require heated surface areas. Thus the architect reaps the benefits of design freedom. Typical for the invisible sports floor heating system is the free choice of wall and window placing.

aquatherm sports floor heating systems, due to a constant heat output, deliver a well balanced temperature profile for the total hall and thus provide a pleasant room condition.

aquatherm sports floor heating: Perfect and maintenance-free technology!

Industrial floor heating



The aquatherm industrial floor heating offers a perfect alternative to so far more usual types of heating.

Advantages

- fast amortisation
- maintenance-free
- total freedom of design
- optimum use of the industrial hall due to embedded heating pipes in the floor
- smooth and constant heat output
- convenient room and working conditions
- dust reduction
- no dust dispersing, due to minimum airflow

Surface heating system for open spaces



The aquatherm heating system keeps open spaces free from ice and snow all the year. Typical fields of application for the open space heating system are pedestrian zones, sports fields, garage drives and gateways, drive-up ramps, open car parks and helicopter pads. In all areas the open space heating system can prevent accidents, e.g. by fall. Furthermore no manpower and equipment is required for snow clearance. Environment polluting grit (e.g. salt) is not necessary. Open space heating normally runs with very low flow temperatures, rarely exceeding 30° C. If in the field of industry rejected heat can be used, no more operating expenses will arise. Approximately 250 Watt / m<sup>2</sup> are required, depending on the circumstances, to keep open spaces free from ice and snow. A mixture of water and anti-freeze is used.

Under soil heating and ice surface cooling



To keep a pitch with natural or artificial turf free from ice and snow aquatherm offers a system to provide an under soil heating efficiently and in consideration of environmental aspects. The ideal combination of climatherm and fusiotherm® compounds, reliably and permanently connected by fusion welding, creates this condition.

The weld-in saddle technique, developed by aquatherm is used for the distribution pipes, manufactured as the manifold connection pipes from climatherm-faser composite pipes. Uncontrolled loss of energy and heat (arising above the pipework in areas which may not be used for heating the pitch) must be avoided. Hence, these pipes must be insulated with a material suitable for the installation under soil.



# **Chapter 1**

System element “heating pipe”

# General description (System element)

## Heating pipes: General description

The operation of a floor heating system is determined by the quality of the heating pipe used.

Typical for the aquatherm®-floor heating pipes are the following features:

- excellent creep strength also at higher temperatures
- smooth inner pipe surface
- low friction loss
- high heat-stabilized
- corrosion resistance
- outstanding resistance against chemicals
- high flexibility
- high impact rate
- less sound of flow
- oxygen-tight due to EVOH-coating acc. to DIN 4726

## Processing

aquatherm®-heating pipes can be laid without preliminary tempering cold from the roll. For practical reasons, the heating pipes should generally be laid with the aquatherm®-pipe hasp.

## Connection technique

Only those pipe joints indicated by the manufacturer should be used for the respective type of pipe.

The aquatherm®-connectors and screw connections for manifolds conform to DIN 8076 Part 1, requested in DIN 4726.

## Linear expansion

aquatherm®-floor heating pipes for wet construction systems are embedded directly into the heating screed.

A change in length resulting from a temperature difference prevented by embedding into the heating screed. The material absorbs tensions so that they are not critical.

## Oxygen-tightness

Manufacturing of the aquatherm®-floor heating pipes with an oxygen barrier layer is achieved according to a specially developed extrusion procedure. Due to the EVOH-coating deposited on the basic pipe as an all-over compound, the pipe reaches an optimum tightness.

The adhesive layer between basis pipe and barrier layer results in an adhesion resisting against hardest site conditions.

The oxygen-tight aquatherm®-underfloor heating pipes are in accordance with DIN 4726.

A system separation by means of a heat exchanger is not necessary as per DIN 4726 when using these pipes.

## Heating water additions

In principle only heating water additions with controlled harmlessness regarding the material used by aquatherm can be used. Heating water additions must be expressly released by aquatherm.

The application of corrosion inhibitors is not necessary when using aquatherm®-underfloor heating pipes.

## Packing

aquatherm®-underfloor heating pipes are packed in site-adapted cardboards impervious to light for protection against mechanical damage or effects from UV-rays.

The pipe bundles have to be stored in the packing until installation.

The pipes are supplied as a ring bundle. Remaining bundles have to be restored in the cardboard.

## External supervision

The supervision contracts necessary in the scope of DIN-CERTCO have been concluded with the SKZ (South German Plastic Centre Würzburg).

## Internal supervision

aquatherm®-underfloor heating pipes are self-supervised according to the requirements of the manufacturing works.

# Heating pipes made of polyethylene (PE-RT)

## Characteristics

aquatherm<sup>®</sup>-underfloor heating pipes made of polyethylene (PE-RT) combined with outside EVOH-barrier acc. to DIN 4721 / 16833 have a unique molecular structure with controlled side chain distribution, ensuring an excellent environment stress cracking resistance, and a very good long term internal pressure behaviour at high flexibility.

## Designation

AQUATHERM FLOOR HEATING PIPE – ART.-NO. 90026 – 16 X 2.0 MM – OXYGEN-TIGHT – DIN 4721 – DIN 16833 – DATE OF MANUFACTURING / TIME – MACHINE-NO – MTR.-MARKING – MADE IN GERMANY

Moreover, every coil is printed continuously with the length in meters. An instruction leaflet containing the identification data is added to every coil.

## Surplus material

Surplus pipes can be applied with the tested and certified aquatherm<sup>®</sup>-SHT-connection technique for radiator connection.



Heating pipes made from PE-RT

aquatherm <sup>®</sup> -Heating pipes made of Polyethylene (PE-RT)		
Art.-No.	Diameter	Length of coil
90024	14 x 2.0 mm	250 m
90034	14 x 2.0 mm	500 m
90026	16 x 2.0 mm	250 m
90036	16 x 2.0 mm	500 m
90027	17 x 2.0 mm	250 m
90037	17 x 2.0 mm	500 m
90028	20 x 2.0 mm	250 m
90038	20 x 2.0 mm	500 m

## Heating pipes made of polyethylene (PE-RT)

### Elastic modulus

The modulus of elasticity as an important parameter of the bending resistance of the pipes is for Polyethylene (PE-RT) at 20° C about 580 N / mm<sup>2</sup>.

Consequently is the smallest admissible

**bending radius 5 x d**

in which d has been determined as outside diameter. For pipes with a diameter of 16 x 2 mm the bending radius will be  $r = 5 \times 16 \text{ mm} = 80 \text{ mm}$ .

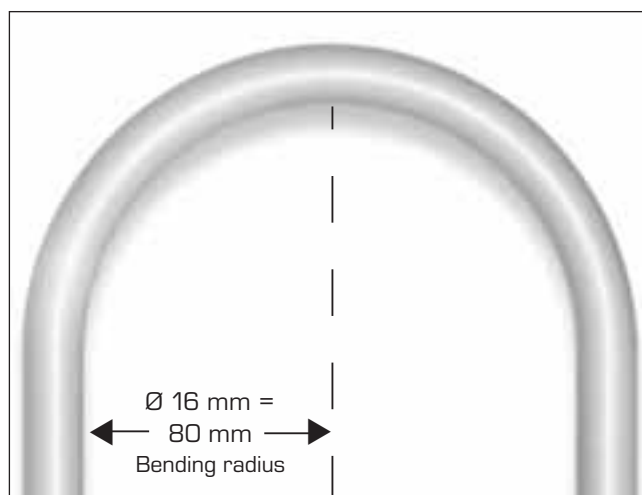

### Physical properties of the material PE-RT

Physical properties	Unit	Test method	Value
Melt-flow index, 190° C / 2.16 kg	g / 10 min	ISO 1133	0.7
Melt-flow index, 190° C / 5.16 kg	g / 10 min	ISO 1133	2.2
Density	g / cm <sup>3</sup>	ISO 1183	0.933
Vicat softening point	°C	ISO 306 (Method A)	122
Thermal conductivity	W / (mk) bei 60° C	DIN 52612-1	0.4
Linear thermal expansion coefficient	10 <sup>-4</sup> / K	DIN 53752 A (20° C - 70° C)	1.95
Mechanical properties	Unit	Test method	Value
Shore hardness D	%	ISO 868	53
Yield stress	MPa	ISO 527	16.5
Yield tensile elongation	%	ISO 527	13
Tensile strength	MPa	ISO 527	34
Elongation at tear	%	ISO 527	> 800
Flexural modulus	MPa	ISO 178	550
Elastic modulus	MPa	ISO 527	580
Izod impact strength	KJ / m <sup>2</sup> at 23° C KJ / m <sup>2</sup> at - 40° C	ISO 180 ISO 180	no break 8
ESCR	H	ASTM D 1693-B 10 %	>8760 (0 Error)
Environment Stress Cracking Resistance	H	50 % anti-freezer (PEG)	>8760 (0 Error)
	H	10 % corrosion inhibitor	>8760 (0 Error)



# Heating pipes made from polybutene (PB)

## Characteristics

aquatherm®-underfloor heating pipes made from the material polybutene (PB) feature among others by their high creep behaviour.

The high heat-aging resistance makes polybutene the ideal pipe material for the heating installation. In the field of small dimensioned connection pipes, polybutene is convincing by its high flexibility.

## Designation

AQUATHERM FLOOR HEATING PIPE – ART.-NO. 90306 – 16 X 2.0 MM – OXYGEN-TIGHT – DIN 4721 – PB 125 – DIN 4726 – DIN 19968/19969 – DIN CERTCO 3V098PB – DATE OF MANUFACTURING / TIME – MACHINE-NO – MTR.-MARKING – MADE IN GERMANY

Moreover, every coil is printed continuously with the length in meters. An instruction leaflet containing the identification data is added to every coil.

## Surplus material

Surplus pipes can be applied with the tested and certified aquatherm®-SHT-connection technique for radiator connection and potable water application.



Heating pipes made from polybutene (PB)

aquatherm®-Floor heating pipe made of polybutene (PB)		
Art.-No.	Diameter	Length of coil
90300	10 x 1.25 mm	250 m
90304	14 x 2.0 mm	250 m
90314	14 x 2.0 mm	500 m
90306	16 x 2.0 mm	250 m
90316	16 x 2.0 mm	500 m
90307	17 x 2.0 mm	250 m
90317	17 x 2.0 mm	500 m
90308	20 x 2.0 mm	250 m
90318	20 x 2.0 mm	500 m

## Heating pipes made from polybutene (PB)

### Elastic modulus

The elastic modulus being an important parameter of the bending resistance of pipes is for polybutene (PB) 20° C approx. 350 N / mm<sup>2</sup>.

Consequently is the smallest admissible

### **bending radius 5 x d**

in which d has been determined as outside diameter.

For pipes with a diameter of 16 x 2 mm the bending radius will be  $r = 5 \times 16 \text{ mm} = 80 \text{ mm}$ .

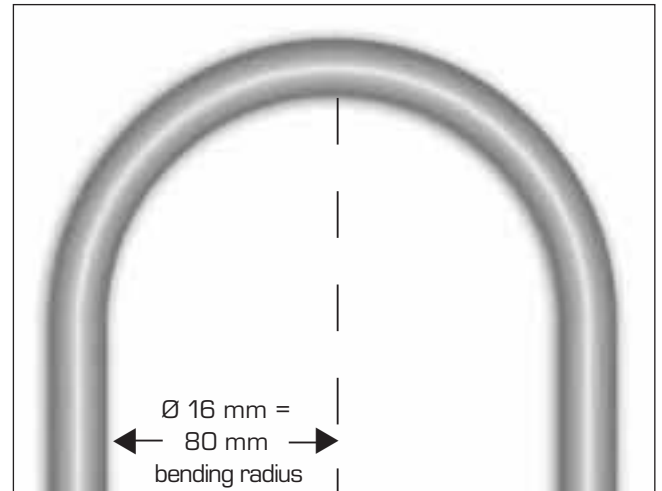

# Surface heating pipes made of multi-layer metal composite pipe

## Surface heating pipes made of multi-layer metal composite pipe

The aquatherm® surface heating pipe 16 mm is composed of electronic ray cross linked polyethylene of high density (PE-HDXc) with laser welded aluminium layer and extra tough coating from high density polyethylene.

aquatherm surface heating pipes 16 mm meet the requirements of DIN 16892 and DIN 4725.

### Colour

White pipe (art.-group 77...) with inner layer aluminium

### Designation

AQUATHERM MULTI LAYER METAL COMPOSITE PIPE –  
ART.-NO. 70070 BPD – 16 MM – OXYGEN-TIGHT –PB 125  
– DVGW DW 8217AT2505 PE-XC / AL / PE-HD IMA –  
DATE OF MANUFACTURING / TIME –MACHINE-NO. –  
MTR.-MARKING - MADE IN GERMANY



Surface heating pipes made of multi-layer metal composite pipe

aquatherm®-surface heating pipes made from multi-layer metal composite pipe		
Art.-No.	Diameter	Length of coil
77070	16 mm	200 m
77072	20 mm	100 m

Exclusively adapter for euroconus Art.-No. 79220 (16 mm) resp. 79222 (20 mm) must be applied for the connection of the aquatherm multi-layer metal composite pipes.

Property	Value
Degree of cross-linking of the basis pipe	65-72 %
Density (compound)	approx. 0.94 g / cm <sup>3</sup>
Tensile strength	approx. 23 N / mm <sup>2</sup>
Elongation at tear	approx. 400 %
Secant E-modulus	approx. 600 N / mm <sup>2</sup>
Thermal conductivity (compound)	0.4 W · m <sup>-1</sup> · K <sup>-1</sup>
Linear thermal expansion coefficient	0.3 x 10 <sup>-4</sup> K <sup>-1</sup>
Maximum system temperature	95° C
Maximum disturbance temperature (temporary)	110° C
Bending radius	< 20 mm Ø → 5 x D resp. 3 x D with appropriate bending support

## climasystem: connection pipes for climasystem heating and cooling grids

### Material

The aquatherm-climasystem is exclusively made from fusiolen® PP-R (80). Its extreme temperature stability is a major property of the product. This physical property is of special interest in the heating and cooling industry.

The exceptionally good welding properties and the fusion result in a homogeneous unit offering a maximum in security and life span. fusiolen® PP-R (80) also offers high temperature and pressure operation.

Long-term temperatures of 70° C can easily be maintained. As a rule, the aquatherm-climasystem operates at substantially lower temperatures than conventional heating systems. Hence, the actual material stressing is substantially lower. Furthermore fusiolen® offers an excellent robustness against various aggressive chemicals.

In conjunction with the climatherm-pipe system (also made from fusiolen® PP-R (80)) for climate, heating and plant technology, aquatherm offers a complete solution from the heating and cooling source.

### Designation

AQUATHERM HEATING-COOLING GRID – FUSIOLEN PP-R 80 – OXYGEN TIGHT – DATE OF MANUFACTURE / TIME – MACHINE-NO. – MTR.-MARKING-MADE IN GERMANY



PP-grid pipe (oxygen-tight, in 2.5 m lengths)

Art.-No.	Diameter	PU
81006	16 x 2.0 mm	50 m
81008	20 x 2.0 mm	50 m



PP-grid pipe (oxygen-tight, in coils)

Art.-No.	Diameter	PU
81026	16 x 2.0 mm	100 m
81028	20 x 2.0 mm	100 m





## **Chapter 2**

### Manifold technique

# aquatherm®-Heating circuit manifold with flow meter

## Characteristics

The aquatherm®-manifold is installed for the distribution and adjustment of the volume flow of each single circuit of the surface heating.

The volume is adjusted with a square spanner at the return valve. The regulated rate of flow can be read directly at the flow meter. Thus always the right volume circulating through circuits is guaranteed.

The distributor can be connected selectable from the right as well as from the left side. All commercial Euroconus connector can be connected with the connection nipple G  $\frac{3}{4}$ " for Euro connection. Made from a high-quality brass pipe MS 63 it is equipped on both sides with a male thread 1" for flat packing connection, end pieces with joints, feed valve, and ventilation valve as well as ball valve set 1" with threaded joint.

The manifold is assembled is on a galvanized sound insulated console acc. to DIN 4109.

Please order accessories (Euroconus connectors) separately.

## Special advantages

Flow meter 0-4 l / m with Quickstop stop valve for flow

Adjustment- and stop valve for return with manual control cap and upper part of a thermostat

Suitable for all commercial Euroconus connectors

Extensive accessories

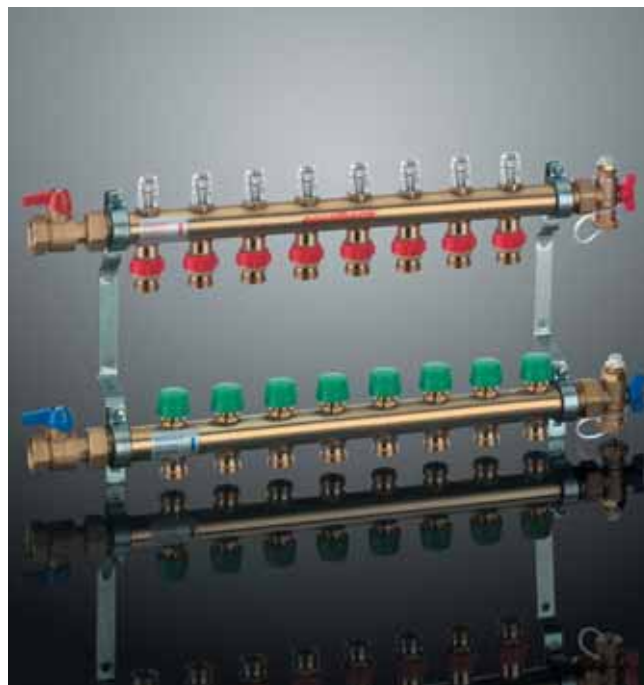

Heating circuit manifold with flow meter

Art.-No.	Size	Circuits	PU
92052	Length: 295 mm	2	1 Pc
92053	Length: 350 mm	3	1 Pc
92054	Length: 405 mm	4	1 Pc
92055	Length: 460 mm	5	1 Pc
92056	Length: 515 mm	6	1 Pc
92057	Length: 570 mm	7	1 Pc
92058	Length: 625 mm	8	1 Pc
92059	Length: 680 mm	9	1 Pc
92060	Length: 735 mm	10	1 Pc
92061	Length: 790 mm	11	1 Pc
92062	Length: 845 mm	12	1 Pc



# aquatherm®-Heating circuit manifold “Object” without flow meter

## Characteristics

The aquatherm®-heating circuit manifold “Object” is installed for the distribution and adjustment of the volume flow of each single circuit of the surface heating.

The volume is adjusted with a square spanner at the return valve.

## Special advantages

Made from high-quality brass MS 63, resistant against bi-metal reaction

Mounted on galvanized sound insulated consoles acc. to DIN 4109

Simple, reciprocal connection by male thread 1"

Connection nipple thread G  $\frac{3}{4}$ " for euroconus  $\frac{3}{4}$ " distance 55 mm

Valve insert/ stop valve in return

Correct flow against the valve insert

Flow and return arranged staggered

Flat packing connections only

Suitable for wall thickness of 90 mm due to low installation depth

Tested for application and pressure

End pieces with ball valve and ventilation valve

Fixing set, packed in boxes

**Ball valves 1" with thread**



Heating circuit manifold “Object” without flow meter

Art.-No.	Size	Circuits	PU
92072	295 mm	2	1 Pc
92073	350 mm	3	1 Pc
92074	405 mm	4	1 Pc
92075	460 mm	5	1 Pc
92076	515 mm	6	1 Pc
92077	570 mm	7	1 Pc
92078	625 mm	8	1 Pc
92079	680 mm	9	1 Pc
92080	735 mm	10	1 Pc
92081	790 mm	11	1 Pc
92082	845 mm	12	1 Pc

## Heating circuit manifold valves

### Return valves

The integrated return valves enable a problem free exchange of the manual construction protection caps against an electro thermal actuator or manual control caps.

The return valves are provided with stainless steel spindles and double o-ring seal.

### Rate control

The hydraulic compensation of the heating circuits is made at the return control valve according to the calculated values.

The mass flow is preset by turning the adjustment spindle left. The actual value at the manifold 92052-92062 is read at the flow meter:

### Packing

The aquatherm®-manifolds are supplied in site adapted cartons.

A set of self-adhesive marking plates is added to every manifold. Same can be adhered on the designated fields of the manual control cap or on the actuator.

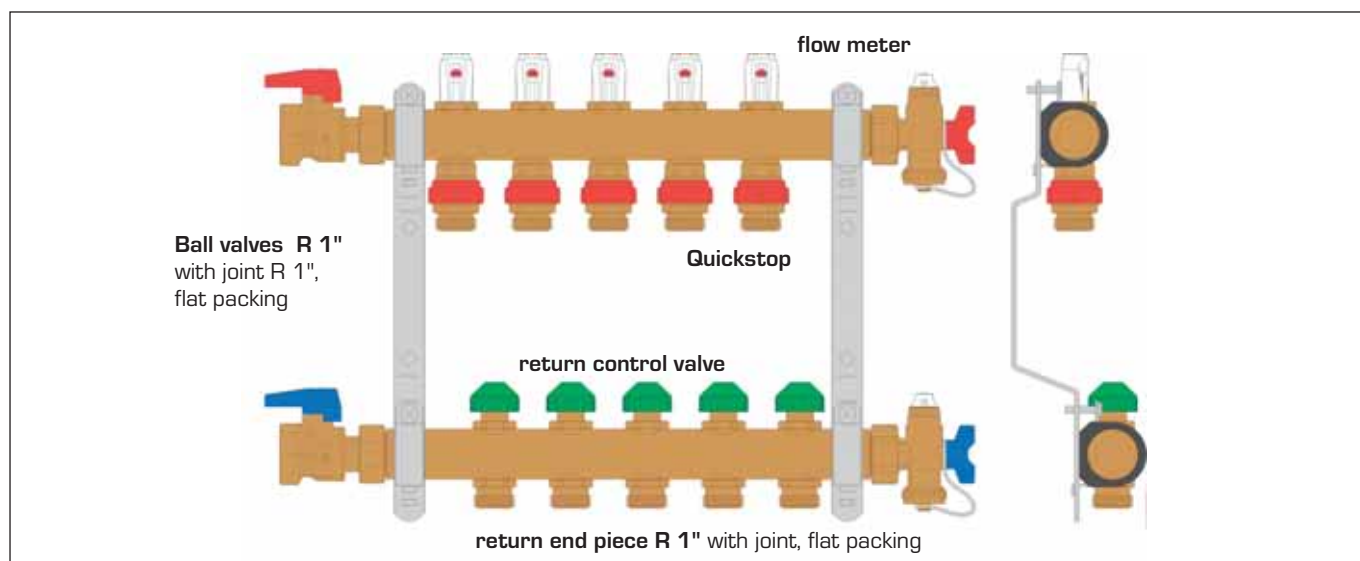

Branches	2	3	4	5	6	7	8	9	10	11	12
Length L in mm	190	245	300	355	410	465	520	575	630	685	740
With ball valve	Length L + 62 mm										
With end piece	Length L + 43 mm										
Total length in mm	295	350	405	460	515	570	625	680	735	790	845
Depth maximum	D approx. 86 mm										
Total length incl. pump module	505	560	615	670	725	780	835	890	945	1000	1055

## Accessories for manifold

### Accessories for manifold

Following accessories for the aquatherm<sup>®</sup>-manifold are available:

#### Euroconus connector

for diameter:

10 x 1.25 mm  
 14 x 2.0 mm  
 16 x 2.0 mm  
 17 x 2.0 mm  
 20 x 2.0 mm



Euroconus connector

10 x 1.25 mm	<b>Art.-No. 92100</b>
14 x 2.0 mm	<b>Art.-No. 92104</b>
16 x 2.0 mm	<b>Art.-No. 92106</b>
17 x 2.0 mm	<b>Art.-No. 92107</b>
20 x 2.0 mm	<b>Art.-No. 92108</b>

#### Connection set

for vertical connection of ball valves



Connection set

Size 1"	<b>Art.-No. 92328</b>
---------	-----------------------

## Accessories for manifold

Universal-flow meter  
add-on kit



Universal-flow meter

Size 1"

Art.-No. 92210

Manual adjustment cap



Manual adjustment cap

with +/- scale

Art.-No. 99109

# aquatherm<sup>®</sup>-Manifold cabinet (concealed installation)

aquatherm<sup>®</sup>-Manifold cabinet  
for concealed installation

## Characteristics

The aquatherm<sup>®</sup>-universal manifold cabinets for concealed installation are made from hot galvanized sheet steel in lacquered design (RAL 9010).

The manifold cabinet is available in five sizes for manifolds from 2 -12 circuits.



Manifold cabinet

<b>Size I</b>	2-3 circuits
<b>Size II</b>	4-6 circuits
<b>Size III</b>	7-10 circuits
<b>Size IV</b>	11-12 circuits
<b>Size V</b>	max. 12 circuits with thermal quantity meter

## Size

Art.-No.	Size	Circuits	Circuits with pump module	Circuits with thermal quantity meter*
93102	Height: 700 - 850 mm Width: 400 mm Depth: 110 - 150 mm	for 2 - 3	-	2
93104	Height: 700 - 850 mm Width: 550 mm Depth: 110 - 150 mm	for 4 - 6	2	3 - 5
93106	Height: 700 - 850 mm Width: 750 mm Depth: 110 - 150 mm	for 7 - 10	3 - 6	6 - 8
93108	Height: 700 - 850 mm Width: 950 mm Depth: 110 - 150 mm	for 11 - 12	7 - 10	9 - 12
93110	Height: 700 - 850 mm Width: 1150 mm Depth: 110 - 150 mm	-	11 - 12	-

\* vertical connection

## aquatherm®-Manifold cabinet (concealed installation)

aquatherm®-Manifold cabinet  
concealed installation

Advice

**See respective drawings for assembly and installation  
of the concealed cabinet on the next page!**

### Special advantages

Universal mounting (C-profile) (3), vertically and horizontally infinitely variable.

Frame (1) with door, infinitely extractable from 110 mm - 150 mm, lacquered in white as per RAL 9010.

The lower lining (6), adaptable to the respective height of the finished floor.

The tubular feed through (2) pre-pressed in the lateral parts.

Enabling an reciprocal pipe guidance.

Bases (5), adjustable up to 160 mm of the total height and applicable as fixed points.

The top hat rail (7), for containing the aquatherm®-connecting systems.

### Installation dimensions /concealed installation

Type of cabinet	UP I	UP II	UP III	UP IV	UP V
Height of cabinet from / to / mm	700 850	700 850	700 850	700 850	700 850
Width of cabinet inside mm	400	550	750	950	1150
Depth of cabinet from / to / mm	110-150				
Recess size height (unfinished state) mm	900	900	900	900	900
Recess size width (unfinished state) mm	450	600	800	1000	1200
Recess size depth (unfinished state) from / to / mm	110-150				

# aquatherm<sup>®</sup>-Manifold cabinet (concealed installation)

## 1. Legend

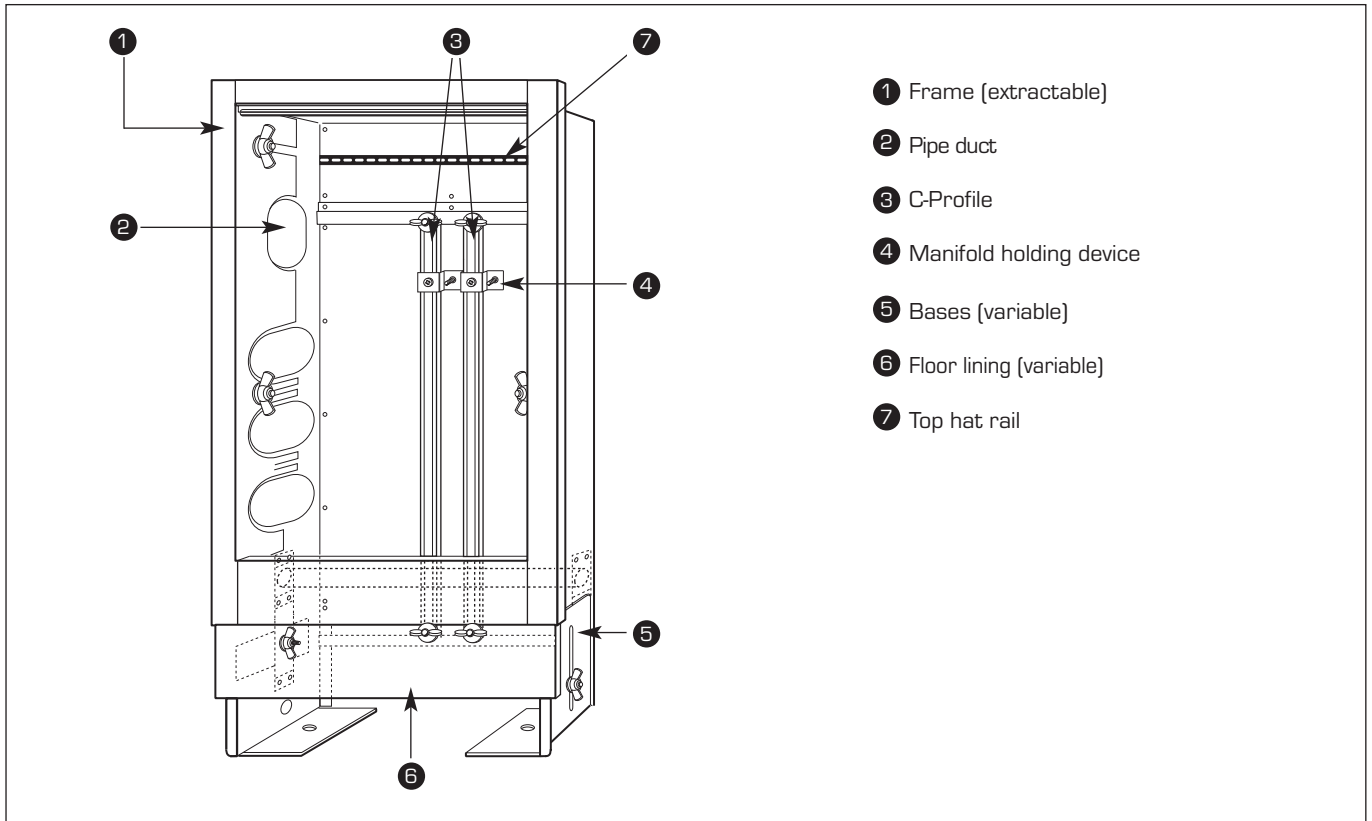

## 2. Construction

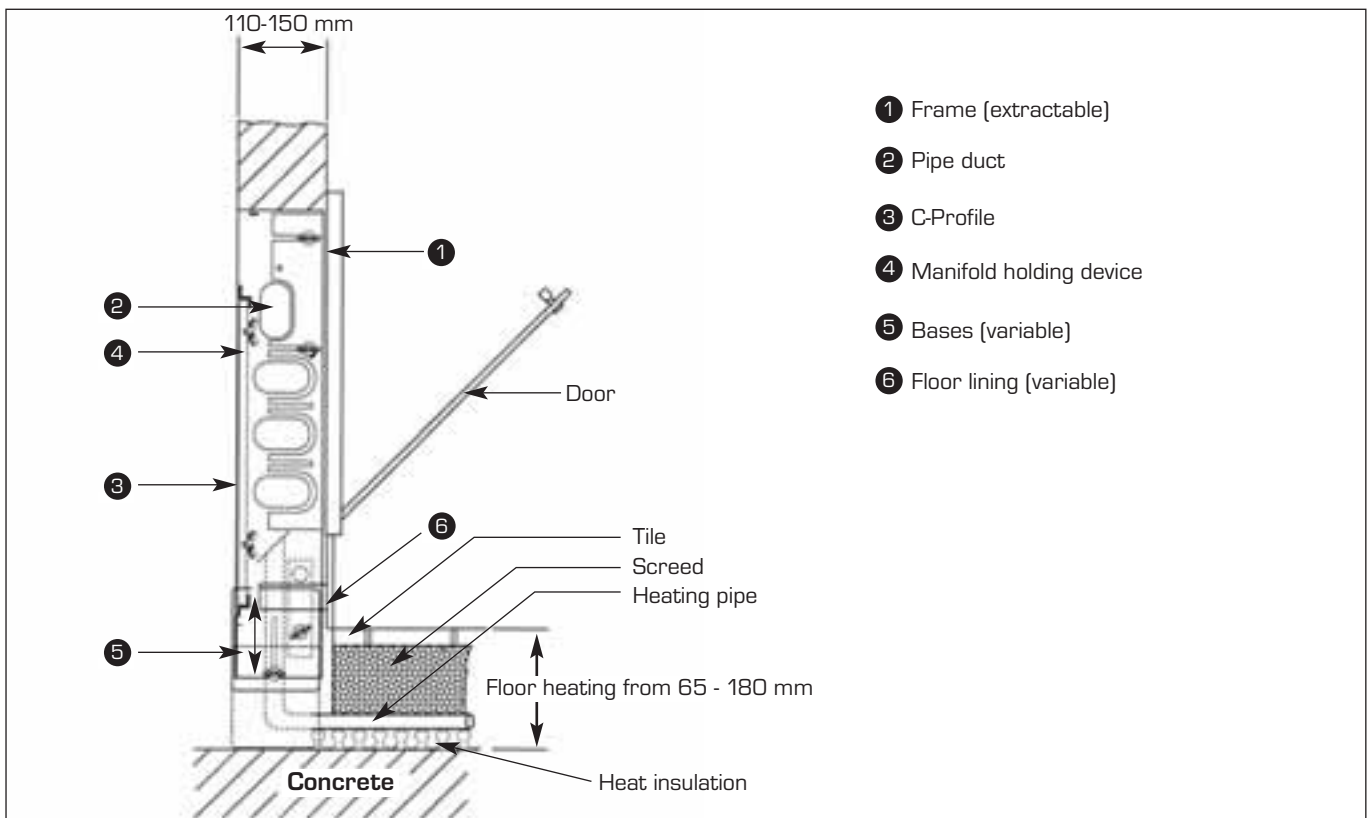

## Universal manifold cabinet (surface installation)

aquatherm®-Universal manifold cabinet for surface installation

### Special advantages

If there is no possibility for concealed installation, the aquatherm®-heating circuit manifold for surface installation is the alternative:

The casing of hot galvanized sheet steel is supplied in lacquered design (RAL 9010 white) including the back panel.

The back panel is also made of hot galvanized sheet steel (without coat of lacquer) and equipped with a cleat for holding the aquatherm®-manifold.



Universal manifold cabinet

### Installation dimensions for surface cabinet

Art.-No.	93112	93114	93116	93118
Type of cabinet	AP I	AP II	AP III	AP IV
Height of cabinet inside mm	730	730	730	730
Width of cabinet outside mm	455	605	805	1005
Depth of cabinet inside mm	128			
Number of heating circuits	2 - 4	5 - 7	8 - 10	11 - 12
Number of heating circuits with heat meter	2	3 - 5	6 - 8	9 - 10



# Pump module

## aquatherm®-Pump module

Composed of:

- ➔ Injection-mixing valve for adjustment of flow temperature in the floor circuit
- ➔ Circulating pump
- ➔ Safety temperature limiter
- ➔ Thermometer

## Adjustment / extension

The adjustment and/or extension of an existing radiator system with underfloor heating is

- ➔ **safe**
- ➔ **economic**
- ➔ **and inexpensive**

practicable.

Only one riser of the radiator's temperature level (e.g. 70 / 50° C) is sufficient.

The rest is adjusted after the installation of the pump module, functioning as a combined adjustment.



Pump module

Art.-No.	Size	PU
92155	up to 80 m <sup>2</sup> heating surface	1 Pc

## Distribution technique

### Mode of operation

The thermostat is directly in the water stream and reacts without any delay to temperature alterations in the circuit flow.

The injection valve is preset to a dimension of  $h = 7$  mm by manufacturer.

The requested flow temperature is regulated by turning the hand wheel left (= higher temperature) or right (= lower temperature).

The scale ring is pressed upwards for adjustment, then the hand wheel can be turned. After successful adjustment the scale ring locks the hand wheel again.

One rotation is 1.5 mm.

The dimension  $h$  for lifting is metered between the scale ring and the case.

The actual flow temperature can be read at the thermometer.

The screwed connecting supply at the top of the injection valve has a double function:

1. **By-pass function:** prevents in closed circuits the rise of pressure in the circuit circulation pump to the maximum.
2. **Main flow:** continuously transmits the current heating flow temperature to the thermostat.

The thermostat (located behind the thermometer) is protected from the hot boiler water. It only reacts to the temperature of the main flow.

This "coating" made of low heat conductive material limits the main flow respectively by-pass to prevent that the circulation pump is short-out hydraulically in the heating circuit.

# Distribution technique

## Installation

The pump module can be mounted at the left or at the right side of the aquatherm<sup>®</sup>-manifold.

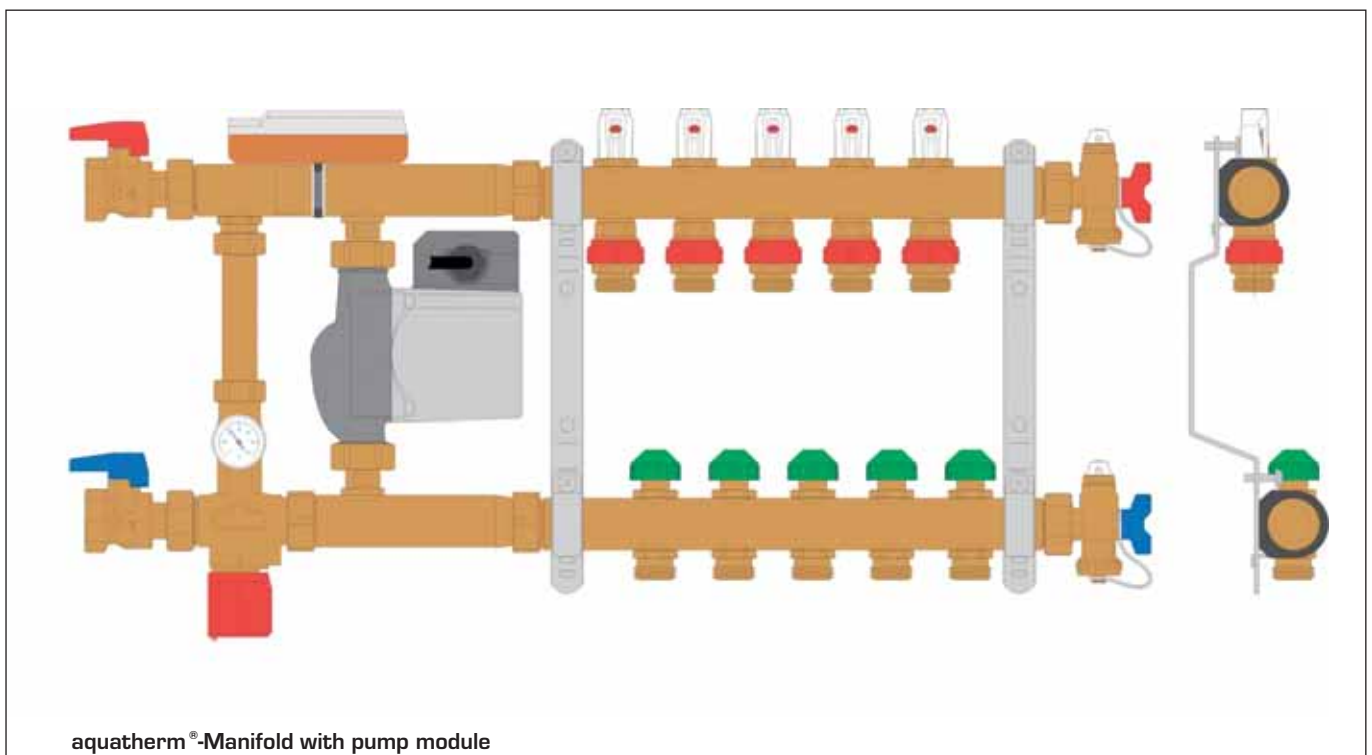
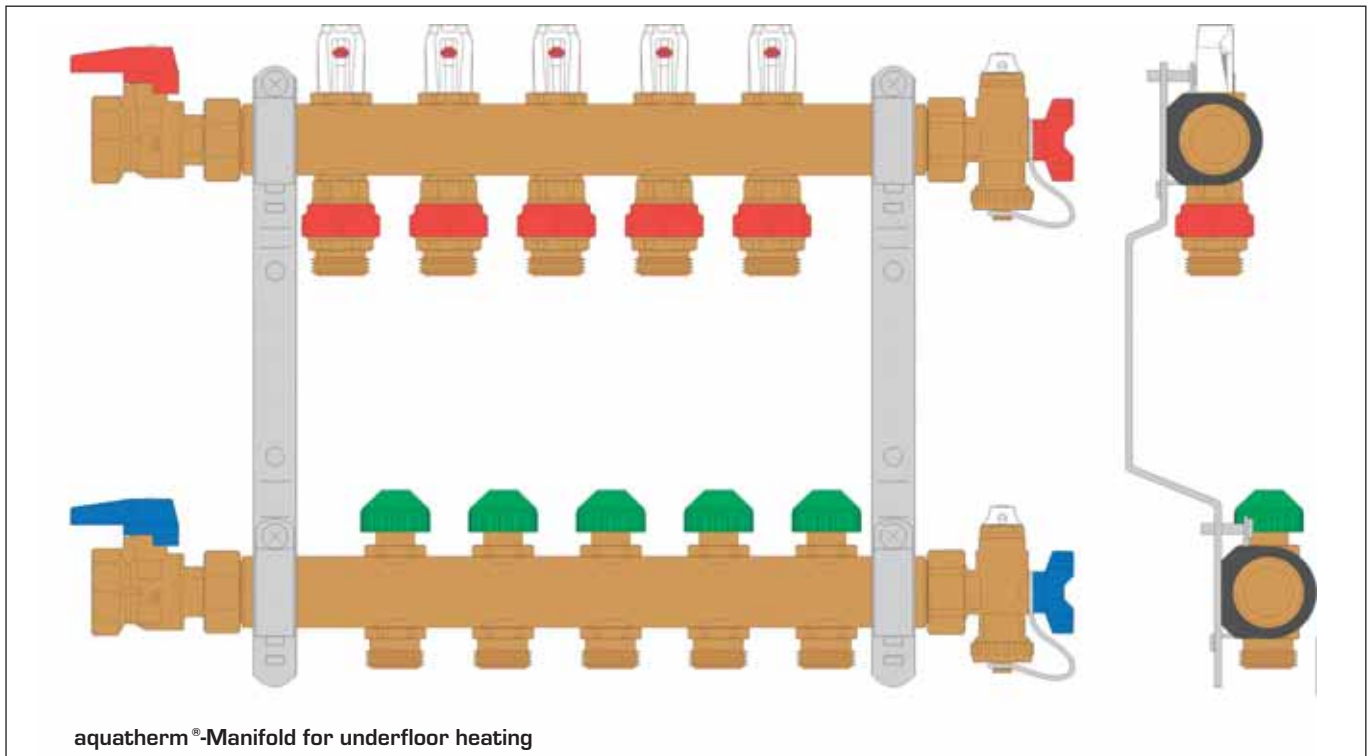

## Distribution technique

### Function

The aquatherm®-pump module works according to the principle of the mixing controls as set value. The required flow temperature for the underfloor heating is adjusted with the hand wheel. The necessary water quantity is mixed from the boiler circuit (e.g. 60° C) via the manifold-return to the underfloor heating circuit.

The safety temperature limiter disconnects the circulation pump when exceeding the maximum temperature.

Room thermostats for the control of individual rooms are urgently requested acc. to heating installation regulations.

As far as only one room is equipped with floor heating, the thermostat can be fitted on the circulation pump.

### Advice

**The aquatherm®-pump module is only designed for application in a pump hot-water heating installation, constructed according to the following plant scheme.**

**Different volumen flows and inlet pressures in front of the control valves and pumps possibly require the application of “an element for hydraulical balancing”.**

**Particularly in connections with boilers the application of “elements for hydraulical balancing” is recommended by aquatherm.**

**(Elements for hydraulical balancing are not part of the aquatherm product range.They must be dimensioned and installed by customers.)**

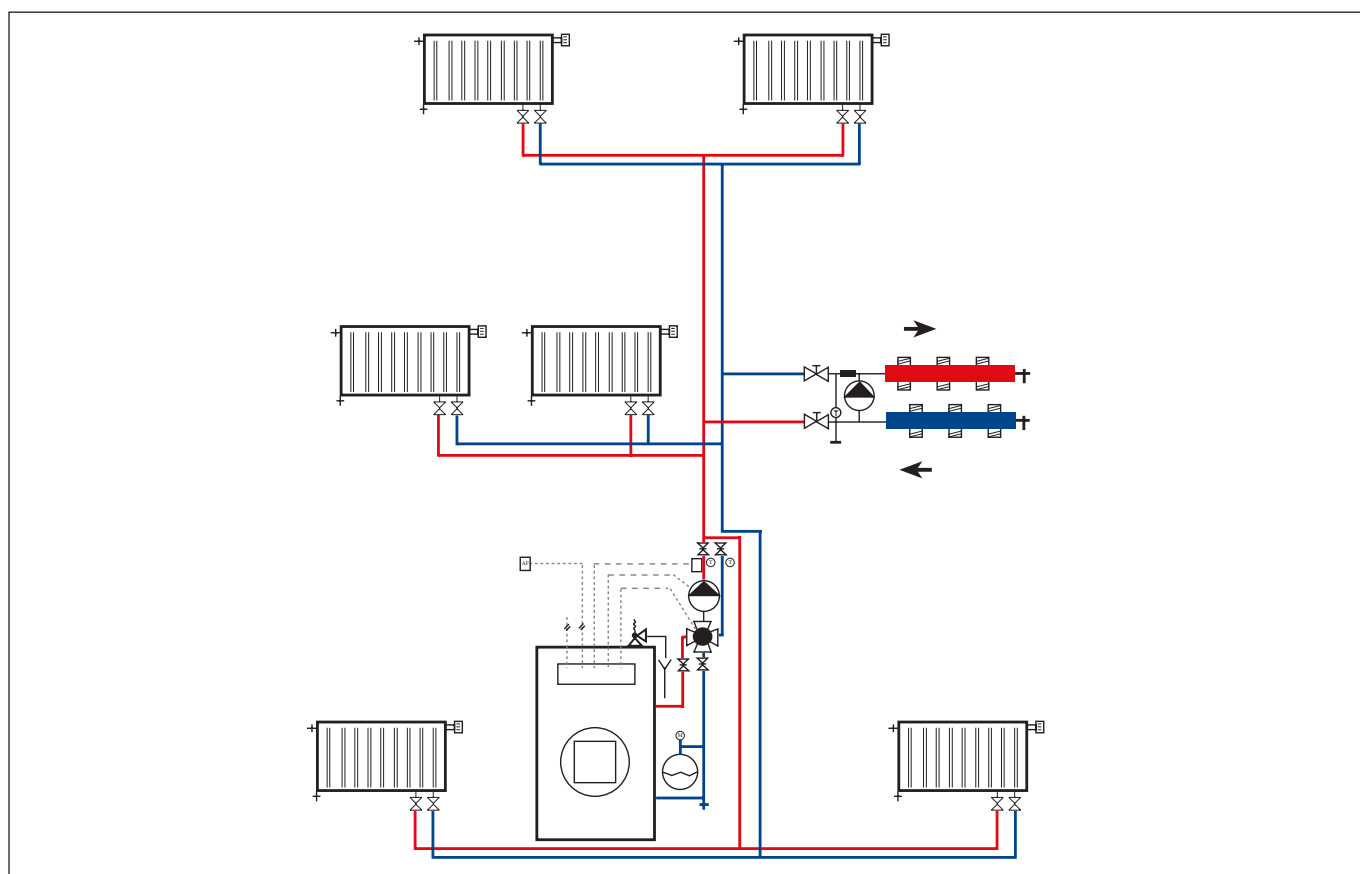

## aquatherm®-Manifold for wide surfaces

### aquatherm®-Manifold for wide surfaces

#### Characteristics

Made from high quality brass pipe MS 63 with:

- flat sealing connection
- endcaps
- filling valves
- flow ball valves with connection for euroconus,  
return valves with stop, connection for euroconus  
and pre-set flow control
- sound insulated and galvanized consols
- low and return arranged staggered

Euroconus connectors must be ordered separately.

Ball valve set must be ordered separately.

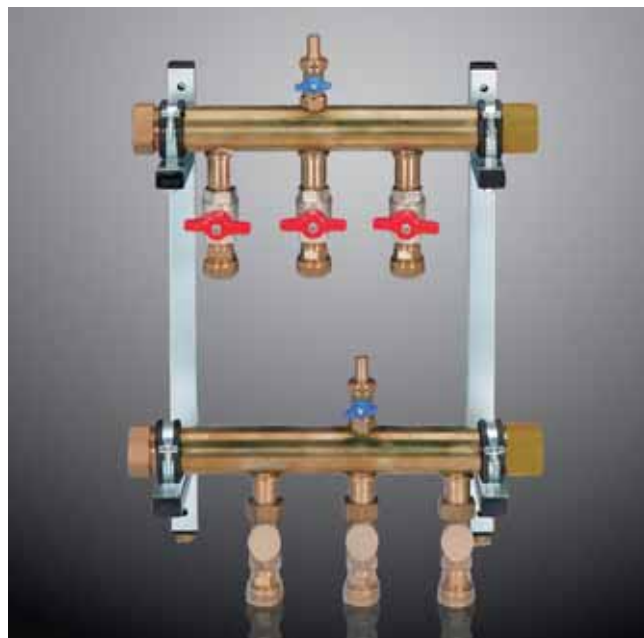

Manifold for wide surfaces

### aquatherm®-Manifold for wide surfaces 1 1/2"

Art.-No.	Size	PU
99062	2-fold / length: 320 mm	1 Piece
99063	3-fold / length: 420 mm	1 Piece
99064	4-fold / length: 520 mm	1 Piece
99065	5-fold / length: 620 mm	1 Piece
99066	6-fold / length: 720 mm	1 Piece
99067	7-fold / length: 820 mm	1 Piece
99068	8-fold / length: 920 mm	1 Piece
99069	9-fold / length: 1020 mm	1 Piece
99070	10-fold / length: 1120 mm	1 Piece
99071	11-fold / length: 1220 mm	1 Piece
99072	12-fold / length: 1320 mm	1 Piece
99073	13-fold / length: 1420 mm	1 Piece
99074	14-fold / length: 1520 mm	1 Piece
99075	15-fold / length: 1620 mm	1 Piece
99076	16-fold / length: 1720 mm	1 Piece
99077	17-fold / length: 1820 mm	1 Piece
99078	18-fold / length: 1920 mm	1 Piece
99079	19-fold / length: 2020 mm	1 Piece
99080	20-fold / length: 2120 mm	1 Piece
99082	Ball valve set 1 1/2"	1 Set
92106	Screw joint 16 x 2 mm	1 Piece
92108	Screw joint 20 x 2 mm	1 Piece

## aquatherm®-Reverse return technique for industrial floor heating

Pipe lay out according to reverse return technique (Tichelmann)

The weld-in saddle technique, developed by aquatherm provides the connection of the heating pipes to a continuous manifold pipe acc. to reverse return.

### Special advantages

For this connection technique the manifold pipes are made from fusiotherm® / climatherm®-pipes and weld-in saddles.

The spacing of saddles is determined by the pipe spacing of the heating pipes.

aquatherm®-SHT transition adapter are applied for the connection of the oxygen-tight heating pipes. They provide an optimum connection between the fusiotherm®-pipe system and the aquatherm®-SHT system (SHT= sliding sleeve technology).

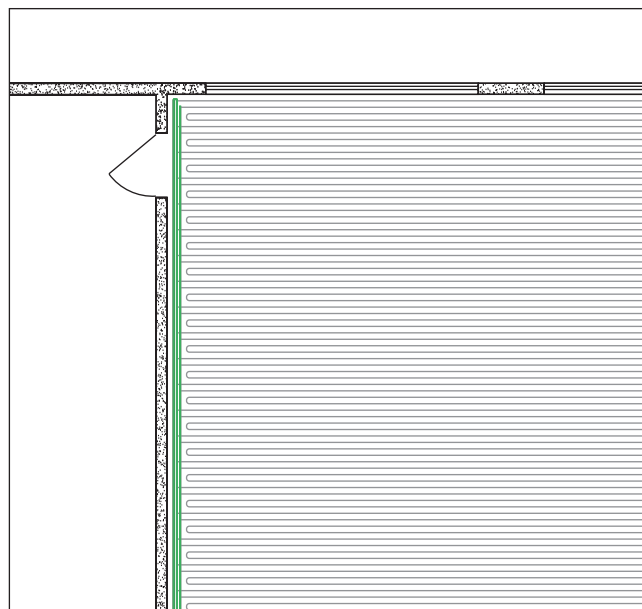

Pipe lay out with weld-in saddle

### Pipe connection fusiotherm® / climatherm® SHT in details

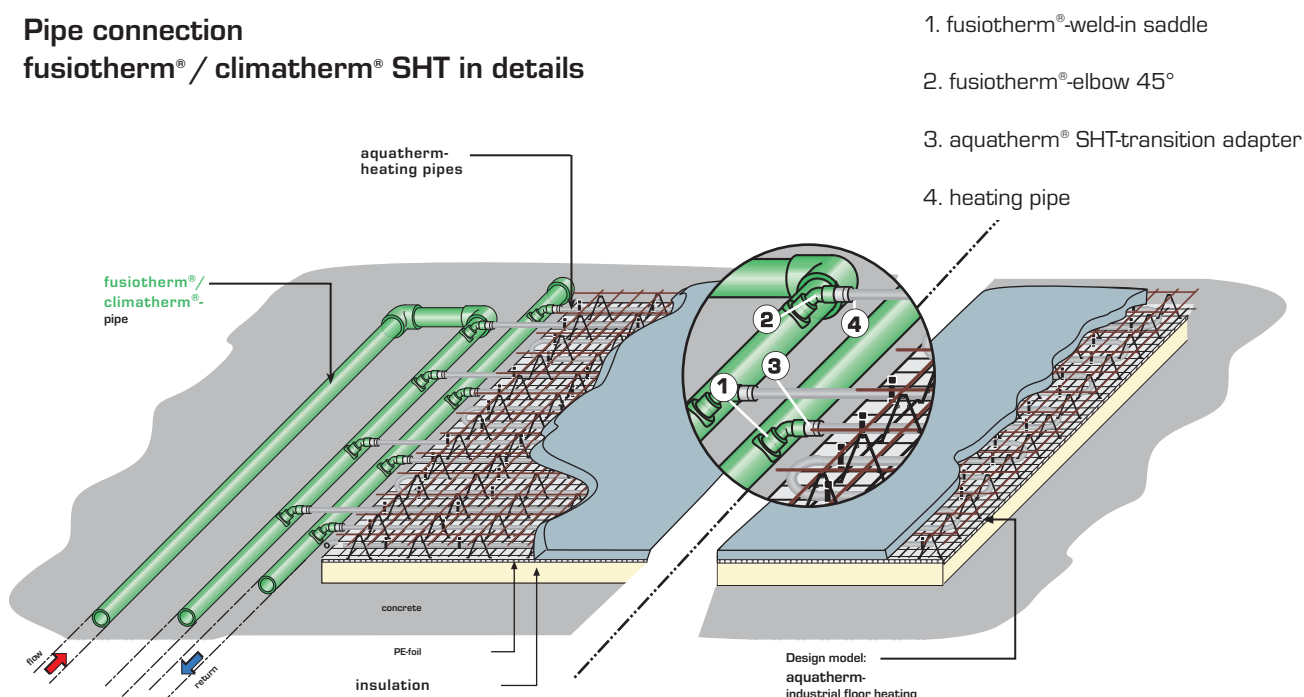

1. fusiotherm®-weld-in saddle
2. fusiotherm®-elbow 45°
3. aquatherm® SHT-transition adapter
4. heating pipe

Design model:  
aquatherm-  
industrial floor heating

# aquatherm®-Reverse return technique for sports floor heating

Pipe lay out according to reverse return technique (Tichelmann)

The weld-in saddle technique, developed by aquatherm provides the connection of the heating pipes to a continuous manifold pipe acc. to reverse return. This technique is applied for the double swing floor design a+b.

On applying the reverse return technique all heating circuits have the same length. Thus the pipe lay out ensures the same pressure loss for all heating circuits. A hydraulic balancing of the heating circuits is not required.

## Installation

For this connection technique the manifold pipes are made from fusiotherm®-pipes and weld-in saddles. The spacing of saddles is determined by the pipe spacing of the heating pipes. aquatherm®-SHT transition adapter are applied for the connection of the oxygen-tight heating pipes. They provide an optimum connection between the fusiotherm®-pipe system and the aquatherm®-SHT system. (SHT= sliding sleeve technology)

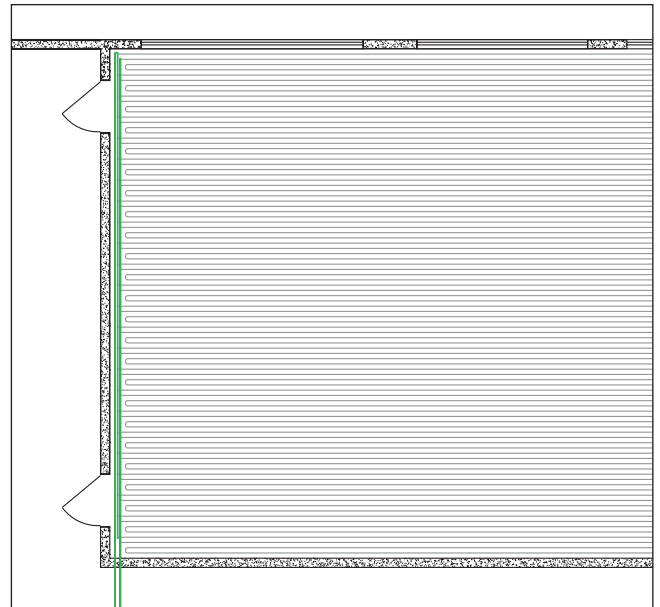

Pipe lay out with weld-in saddle

## Pipe connection fusiotherm® / climatherm® SHT in details

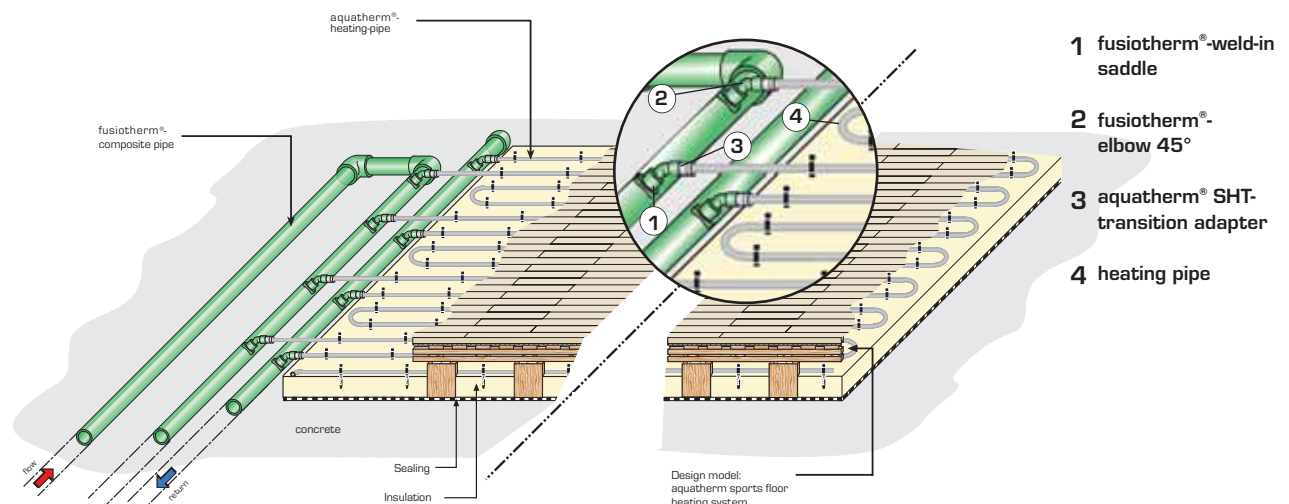





# **Chapter 3**

## Automatic control

# Automatic control

## Requirements

The regulation for energy saving thermal protection and energy saving installation technique for buildings (Decree for Energy Saving – EnEv), stipulates in § 12 Distributing Facilities and Hot Water Systems:

**“Heating systems must be equipped with automatically operating devices for adjusting the temperature in each room.”**

Consequently, every underfloor and wall heating system in residential buildings has to be provided with an individual room control system.

## Pre-control

As defined by the Regulation for Heating Systems the underfloor and wall heating systems must be pre-controlled with outside temperature sensors.

This requirement is met by a sliding operation of the heat generators. In case of combined systems a mixing loop is used so that there is an external temperature control for both control circuits.

## Programmable thermostat (night setback)

A night setback is also useful for underfloor and wall heating systems. Only the setback and heating-up times are advanced accordingly.

Delays of approx. 1.5 - 3.0 hours have to be expected.

## Protection against excess temperature

**A protection against excess temperature is a necessity!**

Normally contact thermostats are installed disconnecting the circulation pump upon excess of the adjusted temperature or closing the mixing motor.

A gravity brake or a return valve have to be used. The excess temperature protection control should be adjusted to 60° C.

## Circulation pump

The circulation pump has to be selected according to the calculated water quantity and the highest pressure loss.

# Automatic control

## aquatherm®-Actuator

### Characteristics

The thermoelectric actuator is a final control element tested by VDE with a spark protection suitable for aquatherm® manifold valves.

It has a special electrically heated expansion system and is controlled by a room thermostat. The actuator works without noise and keeps the valve closed in a powerless condition.

The case is heat resistant and made of shock-resistant plastic.

The actuator is provided with a 100 cm connection cable and especially suitable for installation into manifold cabinets due to its compact design.

The actuator shows a uniform opening and closing course. After expiration of a delay time of approx. 2-3 minutes the opening course procedure is effected by the electrically heated expansion system.

The closing procedure is started after interruption of the current supply by cooling down the expansion system.

The actuation - due to the "first open function" - is supplied currentless open. After snap-on installation - in the shell phase - it is possible to heat without electric drive.

When starting (electrical connection) it is ready by the first lifting (power off).

The valve position indicator registers if the valve is open or closed.

The valve is open when the blue field is indicated. The indicator is well visible from each position.



Actuator

Art.-No.	Technical data	PU
94102	230 Volt	1 Pc
94103	24 Volt	1 Pc

## Automatic control (heating - 230 Volt) Room thermostat & Programmable analogue room thermostat

### aquatherm®-Room thermostat

#### Characteristics

The aquatherm®-room thermostat with thermal feedback controls the room temperature in connection with the aquatherm actuator.

The base is suitable for installation to the wall and on switch boxes. It fits to most switch combinations.

#### Special advantages

The selected room temperature keeps constant.

Energy is saved.

Modern convenience.

The control is designed for night set-back by an external signal (Timer). The adjusted temperature is lowered by approx. 4K. Suitable for group setback if applied with the aquatherm®-connection system (Art.-No. 94140) and with the aquatherm®-programmable analogue room thermostat (Art.-No. 94108)!

### aquatherm®-Programmable analogue room thermostat

#### Characteristics

The aquatherm®-programmable analogue room thermostat is equipped with a daily and weekly program disc.

By this rooms are heated resp. lowered at different times and on different days.

This is an ideal alternative for the heating of:

- ➔ Bedrooms and children´s rooms
- ➔ Office buildings
- ➔ Doctor´s practices
- ➔ Holiday flats



Room thermostat with thermal feedback

Art.-No.	Technical data	Switching difference	Colour	PU
94107	230 V - 50 Hz -10 A	0.5 K	white	1 Pc



Programmable analogue room thermostat

Art.-No.	Technical data	Switching difference	Colour	PU
94108	230 V - 50 Hz -10 A	0.5 K	white	1 Pc

# Automatic control (heating - 230 Volt) connection system

aquatherm®-Connection system  
230 Volt

## Characteristics

With the aquatherm®-connection system AB 2006-N 230 V the actuators are wired rapidly with room thermostats, timer thermostats or clock thermostats.

The usual cable tangle in distribution boxes or cable ducts definitely belongs to the past.

Due to the compact design installation on the top hat rail within the aquatherm® manifold cabinets is guaranteed.

## Special advantages

Perfect individual room control with the aquatherm®-connection system AB 2006-N 230 V by:

Clear allocation of the connection

Proper cable guiding

Up to 6 room thermostats connectable

Up to 14 actuators connectable

Overload protection, overvoltage protection

Ready to be installed into the aquatherm®-manifold cabinet

Plug-in 2 channel digital clock possible

Plug-in extension of control and driving modules possible

Plug-in extension of pump-power module

Installation by screwless connections  
(spring/clamped connection)



Connection system AB 2006-N 230 V

Art.-No.	Technical data	Colour	PU
94140	230 V - 50 Hz -10 A	grey	1 Pc

## Automatic control (heating - 230 Volt) Control module & Actuator module

### Extensions

With an extension module the aquatherm®-connection system AB 2006-N 230 V can be adapted to technical conditions with respect to demands. The extension modules are connected collateral at the integrated cut with the connection system.

The installation of the extension modules is effected according to the installation of the connection systems on the top hat rail in the manifold cabinet.

### aquatherm®-Control module AB RM 2000 N

Plug-in extension to connect  
2 additional thermostats

Connection options: 2 thermostats, 8 actuators

Function display for switching output of the thermostats

#### Technical data

Connection options: max. 2 thermostats  
max. 4 actuators  
per thermostat

Function display: switching output  
thermostat

Housing colour: silver grey (RAL 7001)

Housing colour cover: transparent

Dimension (mm) H / B / L: 70 / 75 / 88

### aquatherm®-Actuator module AB AM 2000 N

Plug-in extension to connect additional actuators  
(more than 4 circuits per thermostat)

Connection option: 2 groups in circuits of 4

Jumpers for selecting the heating zone

#### Technical data

Connection options: 4 actuators max. each for  
2 heating zones of the  
connection system

Function display: jumper for selecting the  
heating zone

Housing colour: silver grey (RAL 7001)

Housing colour cover: transparent

Dimension (mm) H / B / L: 70 / 75 / 88



Control module AB RM 2000 N 230 Volt

Art.-No.	Technical data	Colour	PU
94141	2 thermostates 8 actuators	grey	1 Pc



Actuator module AB AM 2000 N 230 Volt

Art.-No.	Technical data	Colour	PU
94142	2 groups for each 4 actuators	grey	1 Pc

# Automatic control (heating - 230 Volt) Timer module & Pump module

aquatherm®-Timer module  
AB TM 1000 N

Easy programming of heating periods  
(42 storage locations)

2 heating programs (C1 / C2)

Easy operation by clear text menu guiding

6 languages selectable

Automatic switching between summer- / wintertime

### Technical data

Power reserve: approx. 120 h  
Function display: switching output thermostat  
Housing colour: silver grey (RAL 7001)  
Housing lid colour: transparent  
Dimension (mm) H / B / L: 46 / 75 / 65

aquatherm®-Pump module  
AB PL 2000 N

Selection of operation mode pump module resp. power module

Pump module: Automatic shut-down pump,  
Interval mode for summer operation  
Jumper for adjusting the follow-up time 0-15 min.

Power module: load free switching of external units

### Technical data

Connection options: 2 x NYM 2 x 1.5mm<sup>2</sup>  
(through wiring)  
for external units  
Function: Jumper for selecting  
operation mode  
(pump module /  
power module)  
Jumper for adjusting the  
follow-up time  
Floating contact: Changeover contact  
230 V / 5 A (AC)  
Operating voltage: 230 V, 50/60 Hz  
Housing colour: silver grey (RAL 7001)  
Housing lid colour: transparent  
Dimension (mm) H / B / L: 70 / 75 / 88



Timer module AB TM 1000 N

Art.-No.	Technical data	Colour	PU
94143	2 weekly programs 42 storage locations switching between summer / wintertime	white	1 Pc



Pump module AB PL 2000 N 230 Volt

Art.-No.	Technical data	Colour	PU
94144	plug-in extension for switching of circulating pump	grey	1 Pc

## Automatic control (heating, 24 Volt, wireless)

### aquatherm®-Connection system wireless 24 Volt

The aquatherm®-connection system wireless is used for installation of underfloor and wall heating in new buildings as well as for refurbishment.

The advantage of this installation is the wireless and individual placement of the room thermostats, as no mortise and plaster works are necessary.

By SET-key button the heating zone at the wireless connection system is linked to the corresponding wireless room thermostat.

The signal codes sent from the control unit grant an exclusive transmission to the assigned channels.

### aquatherm®-Connection system wireless AB 4071-6

Perfect connection system with six heating zones for room thermostats and actuators

System transfo 24 V plug-in

Automatic temperature setback of two heating programs C1 / C2 by timer module as an option

Option of extension by pump module

#### Technical data

Number of thermostats:	max. 6
Number of actuators:	max. 13
Function display:	operating voltage, safety device, switching output, thermostat
Transformer:	230 V, 24 V, 50 / 60 Hz, 50 vA
Operating voltage :	24 V, 50/60 Hz
Housing colour :	silver grey (RAL 7001)
Housing lid colour:	transparent
Dimension (mm) H / B / L:	70 / 75 / 305



Connection system wireless AB 4071-6 24 Volt

Art.-No.	Technical data	Colour	PU
94148	6 wireless controls 13 actuators	grey	1 Pc



# Automatic control (heating, 24 Volt, wireless)

aquatherm®-Connection system  
wireless AB 4071-12 24 Volt

Perfect connection system with twelve heating zones for  
room thermostats and actuators

System transfo 24 V plug-in

Automatic temperature setback of two heating programs  
C1 / C2 by timer module as an option

Extension module by pump module

## Technical data

Number of thermostats:	max. 12
Number of actuators:	max. 13
Control indicator:	operating voltage, safety device, switch exit, thermostat
Transformer:	230 V, 24 V, 50 / 60 Hz, 50 vA
Operating voltage:	24 V, 50 / 60 Hz
Housing colour:	silver grey (RAL 7001)
Housing lid colour:	transparent
Dimension (mm) H / B / L:	70 / 75 / 305



Connection system wireless AB 4071-12 24 Volt

Art.-No.	Technical data	Colour	PU
94149	12 wireless controls 13 actuators	grey	1 Pc

## Automatic control (heating, 24 Volt, wireless)

### aquatherm®- Pump module AB PL 4000

Selection of operation mode pump module resp. power module by jumper

Pump module: automatic pump shutdown, interval mode for summer operation, adjustable follow-up time 0-15 min

Power module: load free switching of external units

#### Technical data

Number of thermostats: 2 x NYM 2 x 1.5 mm<sup>2</sup>  
(through-wiring)  
for external units

Functions: Jumper for selecting heating zones / operating mode (pump module, power module) Jumper for adjusting the follow-up time 0-15 min.

Floating contact: changeover contact  
230 V / 5 A (AC)

Operating voltage: 24 V, 50 / 60 Hz

Housing colour: silver grey

Housing lid colour: transparent

Dimension (mm) H / B / L: 70 / 75 / 88

### aquatherm®-Room thermostat wireless AR-4070 KF

#### aquatherm®-Connection system wireless

The installation of the wireless room thermostats is simple and flexible due to its assembly without cables. Via SET-button the heating zone of the wireless connection system assigns the corresponding wireless room thermostat.

Temperature control using wireless transmission

Rotary temperature control knob with degree "soft clicks"

Limitation of set temperature range

Selection of operating mode (ON / OFF / AUTOMATIC)

Operating voltage more than 2 x Mignon (AA) Alkaline-Megan-Cells, approx. 5 years lifetime

Transmitter frequency 868 MHz, radiated power approx. 1 mW. Signal coverage in buildings approx. 25 m. Automatic temperature setback (4K)



Pump module AB PL 4000 24 Volt

Art.-No.	Technical data	Colour	PU
94143	plug-in extension for switching of circulating pump	grey	1 Pc

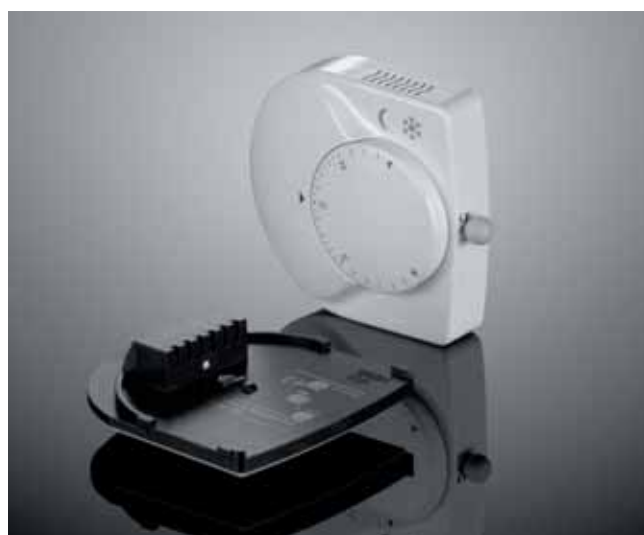

Room thermostate wireless AR-4070 KF

Art.-No.	Technical data	Colour	PU
94151	temperature area 10 - 28° C	white	1 Pc

## Automatic control (heating and cooling - 230 Volt)

### aquatherm®-Connection system 230 Volt

With the aquatherm-connection system ASV 6 the actuators are rapidly wired with the room thermostats.

#### Special advantages

- ➔ clear allocation of the connection
- ➔ proper cable guiding
- ➔ up to 6 room thermostats (Art.-No. 94172) connectable
- ➔ overload protection by exchangeable microfuse
- ➔ overvoltage protection by varistor
- ➔ input: C / O= change over (heating / cooling)
- ➔ input: N / R= normal / reduced operation
- ➔ output: 24 V AC; 5 vA



aquatherm®-Connection-system ASV 6

Art.-No.	Technical data	Colour	PU
94170	6 room thermostats, 12 actuators	white	1 Pc

## Automatic control (heating and cooling - 230 Volt)

aquatherm®-Room thermostat for heating and cooling NRT 210 (2-pipe system)

### Technical data

Temperature range: 10-30° C  
 Differential gap: 0.5 K  
 Breaking capacity: 5 (2) A; 1 relay  
 Dimension (mm) H / B / L: 76 / 76 / 35



aquatherm®-Room thermostat for heating and cooling NRT 210

Art.-No.	Technical data	Colour	PU
94172	temperature area: 10 - 30° C	white	1 Pc

aquatherm®-Room thermostat for heating and cooling NRT 220 (4-pipe system)

### Technical data

Temperature range: 10-30° C  
 Differential gap: 0.5 K  
 Breaking capacity: 2 (1,2) A; 2 relays  
 Dead zone: 1.5 K extended 7 K  
 Dimension (mm) H / B / L: 76 / 76 / 35



aquatherm®-Room thermostat for heating and cooling NRT 220

Art.-No.	Technical data	Colour	PU
94174	temperature area: 10 - 30° C	white	1 Pc

# Automatic control (heating and cooling - 24 Volt)

## aquatherm®-Connection system 24 Volt

### Characteristics

With the aquatherm®-connection system AB 4001-6 24 V the actuators are wired rapidly with room thermostats, timer thermostats or clock thermostats.

The usual cable tangle in distribution boxes or cable ducts definitely belongs to the past.

Due to the compact design installation on the top hat rail within the aquatherm®-manifold cabinets is guaranteed.

### Special advantages

Perfect individual room control with the aquatherm®-connection system AB 4001-6 24 V by:

Clear allocation of the connection

Proper cable guiding

Up to 6 room thermostats connectable

Up to 14 actuators connectable

Overload protection, overvoltage protection

Ready to be installed into the aquatherm®-manifold cabinet

Plug-in 2 channel digital clock possible

Plug-in extension of control and driving modules possible

Plug-in extension of pump-power module

Installation by screwless connections  
(spring / clamped connection)



Connection system AB 4001-6 24 Volt

Art.-No.	Technical data	Colour	PU
94152	230 V / 24 V - 50 Hz -50 vA	grey	1 Pc

## Automatic control (heating and cooling - 24 Volt)

### Extensions

With an extension module the aquatherm®-connection system AB 4001-6 24 V can be adapted to technical conditions with respect to demands. The extension modules are connected collateral at the integrated cut with the connection system.

The installation of the extension modules is effected according to the installation of the connection systems on the top hat rail in the manifold cabinet.

### aquatherm®-Control module AB RM 4000 24 Volt

Plug-in extension to connect 2 additional thermostats

Connection options : 2 thermostats, 8 actuators

Function display for switching output of the thermostats

#### Technical data

Connection options: max. 2 thermostats  
max. 4 actuators  
per thermostat

Function display: switching output  
thermostat

Housing colour: silver grey (RAL 7001)

Housing colour cover: transparent

Dimension (mm) H / B / L: 70 / 75 / 88

### aquatherm®-Actuator module AB AM 4000 24 Volt

Plug-in extension to connect additional actuators  
(more than 4 circuits per thermostat)

Connection option: 2 groups in circuits of 4

Jumpers for selecting the heating zone

#### Technical data

Connection options: 4 actuators max. each for  
2 heating zones of the  
connection system

Function display: jumper for selecting the  
heating zone

Housing colour: silver grey (RAL 7001)

Housing colour cover: transparent

Dimension (mm) H / B / L: 70 / 75 / 88



Control module AB RM 4000 24 Volt

Art.-No.	Technical data	Colour	PU
94131	2 thermostates 8 actuators	grey	1 Pc



Actuator module AB AM 4000 24 Volt

Art.-No.	Technical data	Colour	PU
94132	2 groups for each 4 actuators	grey	1 Pc

# Automatic control (heating and cooling - 24 Volt)

## aquatherm® -Timer module AB TM 1000 N

Easy programming of heating periods  
(42 storage locations)

2 heating programs (C1 / C2)

Easy operation by clear text menu guiding

6 languages selectable

Automatic switching between summer- / wintertime

### Technical data

Power reserve: approx. 120 h  
Function display: switching output thermostat  
Housing colour: silver grey (RAL 7001)  
Housing lid colour: transparent  
Dimension (mm) H / B / L: 46 / 75 / 65



Timer module AB TM 1000 N

Art.-No.	Technical data	Colour	PU
94143	2 weekly programs 42 storage locations switching between summer / wintertime	grey	1 Pc

## aquatherm®-Pump module AB PL 4000 24 Volt

Selection of operation mode pump module resp.  
power module

Pump module: Automatic shut-down pump  
Interval mode for summer operation  
Jumper for adjusting the follow-up time 0-15 min

Power module: load free switching of external units

### Technical data

Connection options: 2 x NYM 2 x 1.5mm<sup>2</sup>  
(through wiring)  
for external units  
Function: Jumper for selecting  
operation mode  
(pump module /  
power module)  
Jumper for adjusting the  
follow-up time  
Floating contact: Changeover contact  
230 V / 5 A (AC)  
Operating voltage: 24 V, 50/60 Hz  
Housing colour: silver grey (RAL 7001)  
Housing lid colour: transparent  
Dimension (mm) H / B / L: 70 / 75 / 88



Pump module AB PL 4000 24 Volt

Art.-No.	Technical data	Colour	PU
94150	plug-in extension for switching of circulating pump	grey	1 Pc

## Automatic control (heating and cooling - 24 Volt)

### aquatherm®-Heating-cooling module AB HK 4000 24 Volt

The plug-in extension of the connection system automatically initiates the change-over of all connected room thermostats into the cooling mode by external potential-free contact or manually.

#### Technical data

Function display: mode heating / cooling  
 Input: potential-free contact  
 Operating voltage: 24 V, 50 / 60 Hz  
 Housing colour: silver grey (RAL 7001)  
 Housing lid colour: transparent  
 Dimension (mm) H / B / L: 46 / 75 / 65



Heating-cooling module AB HK 4000 24 Volt

Art.-No.	Technical data	Colour	PU
94153	Plug-in extension for changeover from heating to cooling	grey	1 Pc

### aquatherm®-Room thermostat for heating and cooling in one system AR 4010 K 24 Volt

#### Technical data

Temperature range: 10-28° C  
 Operating voltage: 24 V, 50 / 60 Hz  
 Display: Symbol for temperature lowering "moon", cooling operation "ice crystal"  
 Switching current: 1.0 A  
 switching capacity: max. 5 actuators 24 V  
 Dimension (mm) H / B / L: 80 / 93 / 27

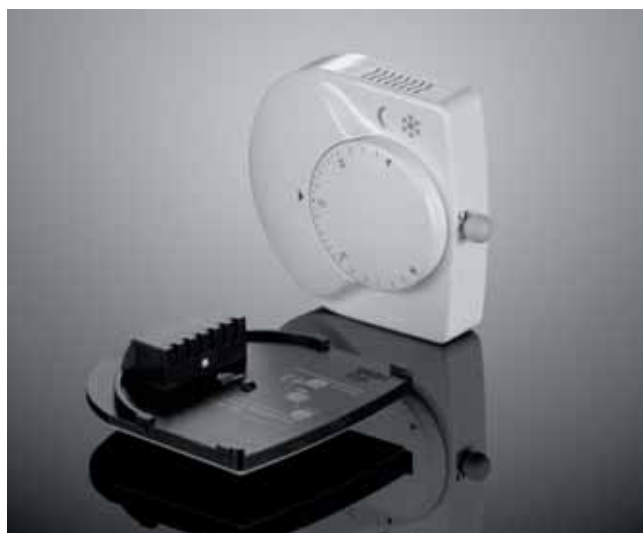

Roomthermostat AR 4010K; heating and cooling 24 Volt

Art.-No.	Technical data	Colour	PU
94154	Temperature range: 10-28° C	white	1 Pc



## Automatic control (heating and cooling - 24 Volt)

aquatherm®-Room thermostat  
for heating (24 Volt)

### Technical data

Temperature range: 10-28° C  
 Operating voltage: 24 V, 50 / 60 Hz  
 Switching current: 1.0 A  
 switching capacity: max. 5 actuators 24 V  
 Dimension (mm) H / B / L: 80 / 84 / 27

**Automatical temperature lowering (4K) by external  
breaker signal.**

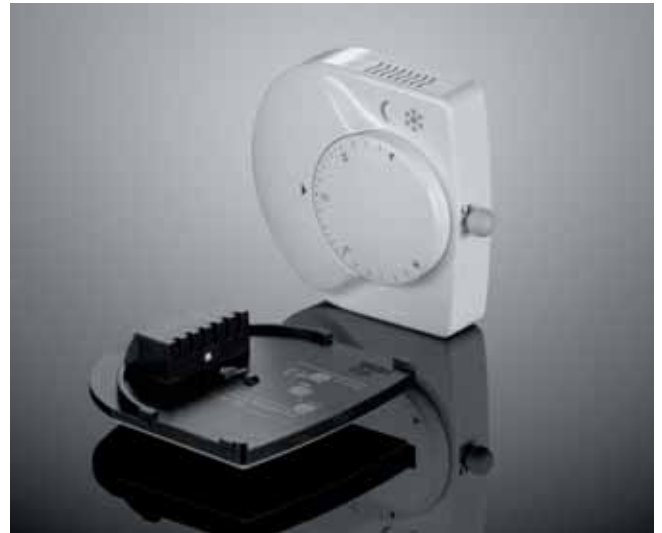

Room thermostat for heating 24 Volt

Art.-No.	Technical data	Colour	PU
94156	Temperature range: 10-28° C	white	1 Pc

## Automatic control (Zone control edge / straight)

### aquatherm®-Zone control

The aquatherm®-zone control is used in projects to control individual rooms completely via an independent heating circuit manifold.

By this it is not necessary to equip each individual circuit with an actuator.

The complete manifold is controlled via room- or clock thermostat by the aquatherm®-zone control.

Only the hydraulic adjustment of each circuit within the heating zone has to be made at the manifold.



Zone control straight



Zone control edge

Art.-No.	Size	PU
94106	1" straight	1 Pc
94101	1" edge	1 Pc

# Automatic control (aquatherm<sup>®</sup>-mixing control unit)

## aquatherm<sup>®</sup>-Mixing control unit

The aquatherm<sup>®</sup>-mixing control unit is used for a constant control of the flow temperature.

It is applied in rooms fully equipped with underfloor / wall heating or in combined underfloor / wall heating / radiator heating systems from which the underfloor heating covers a partial load of the heat demand or when a constant surface temperature is requested.

The flow temperature is kept constant at the adjusted value by mixing the heating water from the boiler and the by-pass.

The mixing control is designed in the dimension of 1" for surfaces up to 120 m<sup>2</sup>.

The control unit combines following control elements in one unit:

- ⇒ Circulation pump
- ⇒ Control valve incl. flow sensor
- ⇒ By-pass valve with manual adjustment cap
- ⇒ Safety temperature limiter
- ⇒ Flow and return thermometer
- ⇒ Differential pressure overflow valve
- ⇒ Stop valves for flow and return



Mixing control unit

Art.-No.	Size	PU
94008	1"	1 Pc

## Automatic control (aquatherm®-control unit analogue)

### aquatherm®-Control unit analogue

The aquatherm®-control unit is a heating circuit control depending on the outside temperature.

The control unit is supplied as an universal applicable heating circuit control, ready for installation.

#### Applications:

- ➔ **underfloor heating**
- ➔ **wall heating**

The control units combines the following control elements in one unit:

- ➔ Heating control depending on outside temperature with
  - ➔ automatic switch (analogue) and power reserve (adjustable from daily to weekly program)
  - ➔ program selection switch
  - ➔ control button for temperatures with normal and reduced operation
  - ➔ 3-way mixer
    - ➔ mixer motor with mounting accessories
- ➔ Circulation pump
- ➔ Safety temperature limiter at flow
- ➔ Outside sensor
- ➔ Differential pressure overflow valve
- ➔ Flow and return thermometer
- ➔ Stop valves for flow and return



Control unit

Art.-No.	Size	PU
94028	1"	1 Pc

# Automatic control (aquatherm<sup>®</sup>-Control unit digital)

## aquatherm<sup>®</sup>-Control unit digital

The aquatherm<sup>®</sup>-control unit is a digital circuit control depending on the outside temperature.

The control unit is supplied as an universal applicable heating circuit control, ready for installation.

### Applications:

- ➔ Underfloor heating
- ➔ Flexible sports floors
- ➔ wall heating
- ➔ industrial floor heating

The control unit combines the following control elements in one unit:

- ➔ Heating control depending on outside temperature with
- ➔ Automatic switch (digital)
- ➔ Load-dependent variable flow temperature
- ➔ High-temperature limiter
- ➔ 3-way mixer with actuator
- ➔ Circulation pump
- ➔ Insulation shell made from EPP
- ➔ Outside sensor
- ➔ Differential pressure overflow valve
- ➔ Flow- and return thermometer
- ➔ Stop valves for flow and return
- ➔ Accessories for wall mounting

Circulation pump, control unit and actuators are fully wired ex-factory.



Control unit digital

Art.-No.	Size	PU
94029	1"	1 Pc



## **Chapter 4**

### Floor construction for housebuilding

# DIN-Regulations

## DIN-Regulations

### European minimum insulation acc. to EN 1264-4

After introduction of the Energy Saving Regulation (EnEV) on 01.02.2002 a minimum insulation acc. to EN 1264, Part 4 for floor heating systems is valid for all European countries to the contract.

This standard is effective for floor heating systems in residential buildings, in offices and all buildings similar to residential buildings.

### Energy Saving Regulation EnEV

The Energy Saving Regulation EnEV is in force since 01.02.2002.

For construction applications from 01.02.2002 the EnEV must be applied.

The EnEV is only effective for the Federal Republic of Germany. The minimum insulation acc. to technical rules is required herein.

### The following has to be considered for hot-water underfloor heating systems:

flat separation ceilings against unheated rooms  
= requirements acc. to DIN 4108-4

ceilings against unheated rooms  
= requirements acc. to EnEV

ceilings against ground  
= requirements acc. to EnEV

ceilings against outside air  
= requirements acc. to EnEV

Designs with better insulation than required in DIN 4108-4 or in EnEV should be passed to the planner.

### The following regulations and DIN-standards also have to be considered exactly.

(Individual regional regulations are disregarded)

#### General standards and regulations:

- DIN 4102 Behaviour of materials and components in fire
- DIN 4108 Thermal insulation in high buildings
- DIN 4109 Sound insulation in high buildings
- DIN 18195 Buildings sealing
- DIN 18202 Dimensional tolerance in high buildings
- DIN 18336 Sealing against pressing water
- DIN 18337 Sealing against non-pressing water

#### VOB Contract procedure for building works, part C

- DIN 18352 Tiles and plate works
- DIN 18353 Screed works
- DIN 18356 Parquetry
- DIN 18365 Floor covering works

#### Components of the floor construction

- DIN EN 1363
- DIN 18560 Screed in building works



# Conditions for installation

## Conditions for installation

The conditions for placing on site have to be checked prior to starting the installation.

The following conditions are required for a perfect installation:

- 1.)** Walls and ceilings have to be plastered, tiled or prepared in such a way that there is no dirt accumulation after placing of the underfloor heating.
- 2.)** Windows and outside doors have to be installed.  
[ Screed has to be protected against weather!]
- 3.)** For rooms adjacent to the ground a humidity sealing as per DIN has to be installed. If there is no sealing, the works supervisor must be informed in order to clarify the conditions prior to the start of installation.

In case of buildings sealing made of bituminous material or other plasticizer separating materials an intermediate foil has to be laid before placing the polystyrene heat impact sound insulation.

On using polyurethane HR foam boards the intermediate foil is not necessary.

- 4.)** The grounding may not have coarse unevenness, point bumps, different levels or insufficient solid surfaces.

The tolerance of flatness must correspond to the requirements of DIN 18202 "Tolerances in high buildings" (flatness tolerances for surfaces of covers and walls).

The requirements of DIN 18560 as well as DIN EN 1264 have to be considered. The rough concrete cover has to be cleaned by the customer.

- 5.)** The aquatherm<sup>®</sup>-manifolds are installed and tested under pressure.
- 6.)** Connecting supplies for individual room control are planned and laid.

## Exceptions

Types of building, which are not subject to the EN 1264-4

The insulation of buildings, which are not subject to the EN 1264-4 (e.g. industrial buildings, industrial halls, sports halls, etc.) must be performed acc. to DIN 4108, part 2, edition March 2001 as follows:

Internal temperature	Minimum temperature thermal transfer resistance of floor
< 12° C	no requirement
12° C oder 19° C annual use more than 4 months heated	R= 0.55 m <sup>2</sup> K / W
> 19° C	R= 0.90 m <sup>2</sup> K / W

If the selected thermal protection is better than the minimum thermal protection, the heating planner must know the U-value (former K-value) of the ceiling for consideration.

### Exemption from insulation requirements of EnEV

The exemption from the insulation requirements is possible acc. to EnEV § 17 "Exemptions".

An extract:

"An undue hardship is existent, if the required expenses within the useful life with requirements to the existing buildings within a reasonable period cannot be achieved by the savings."

## Effects of the DIN-Regulations

With validity of the EN 1264-4 hot water underfloor heatings for residential, office and other buildings, the use of which refers to that of residential buildings, the following alterations must be respected:

- ➔ The underfloor heating pipes must be installed with distances of more than 50 mm from vertical building elements and more than 200 mm from chimneys, firesides, open or stonewalled ducts as well as from lift shafts.
- ➔ The fixing distances of pipe clamps must be limited to 500 mm.
- ➔ Underfloor heating pipe couplings in the floor construction must be positioned and marked exactly in the revision drawing.
- ➔ The maximum temperature close to the heating elements in the screed is limited to 55° C. For anhydrite-screed the maximum temperatures, as recommended by the manufacturer should be applied.
- ➔ Before laying the screed the heating circuits must be pressurized with water. The test pressure must be double that of the operating pressure – minimum 6 bar and must be kept during the screed filling process.
- ➔ Each heated room must be equipped with at least one circuit.
- ➔ The combining of small rooms (e.g. WC and porches, hall etc.) to one circuit is not allowed.

When laying the heating pipes in the aquatherm®-system element 30 and 50 and also in the knob plate the required minimum distances of the pipe fixing of 500 mm is always applied.

For the system element valufix roll 35-3 2.5 pieces of pipe holder must be provided per metre of heating pipe.

## Examples of design

Example for floor construction with building sealing by customer acc. to DIN 18195 with aquatherm®-system element valufix roll 35-3.

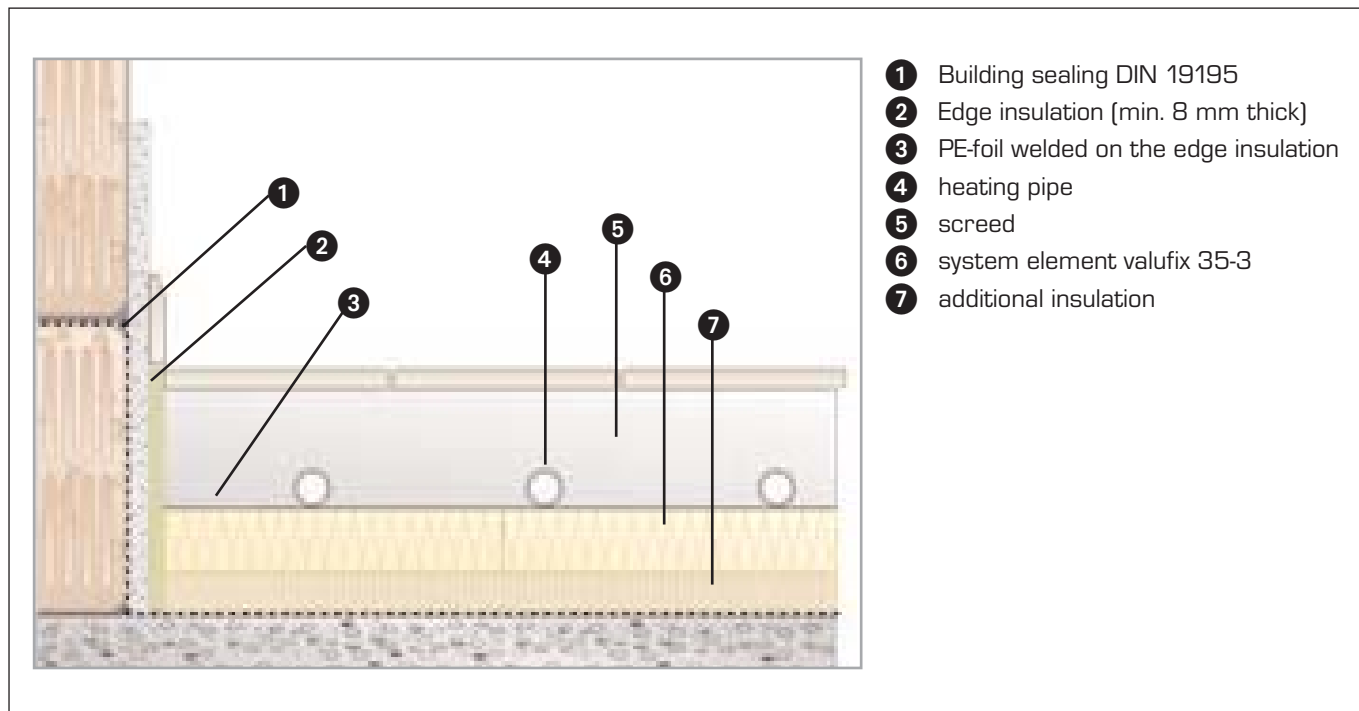

Example for floor construction with building sealing by customer acc. to DIN 18195 and additional sealing against surface water (baths, shower, etc.) acc. to DIN 19337 (sealing above the heating surface), with aquatherm®-system element knob plate F ND 35-3.

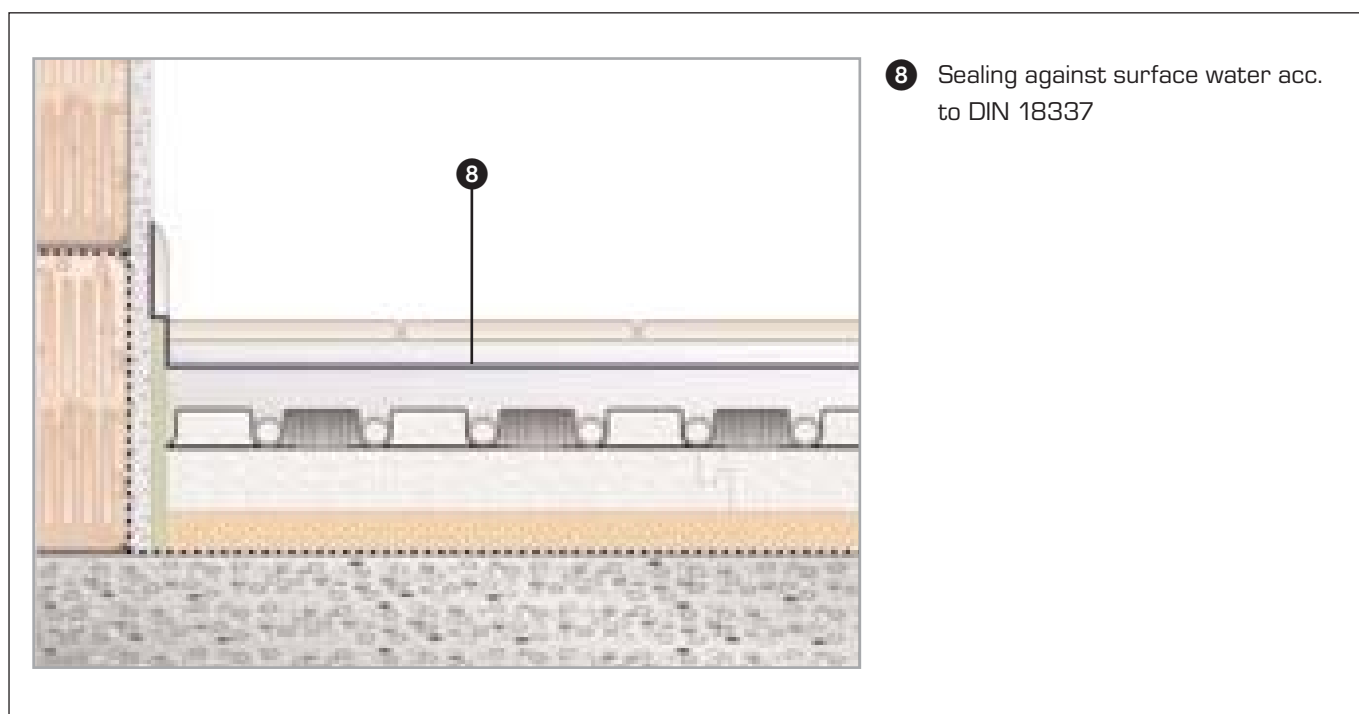

# Impact sound insulation

## Impact sound insulation

Since the publishing of DIN 4109 in November 1989, requirements and demands for sound insulation have been regulated. This standard aims to protect people against unacceptable nuisances of sound transmission.

In the field of underfloor heating the impact sound insulation concerns planners, trade and building-owners.

Following components have to be considered:

- Rough cement floor
- Impact sound insulation
- Screed
- Edge insulation

(soft elastic floor coverings may not be considered due to the possible interchangeability).

The calculation procedure of DIN 4109 uses the following terms:

- $L_n, W, eq, R$  = equivalent evaluated standard impact sound insulating level
- $\Delta L_w, R$  = impact sound improvement dimension
- $L'_n, W$  = evaluated standard impact sound insulating level

The equivalent standard impact sound insulation level considers the mass of the rough cover in relation to the surface (solid cover).

(DIN 4109, supplement 1, table 16)

With the impact sound improvement dimension the impact sound insulating effect of the cover coat (insulating material) is considered.

(DIN 4109, supplement 1, table 17)

The evaluated standard impact sound insulating level is the requirement of DIN 4109, supplement 2, table 2 + 3.

It is distinguished according to the following criteria:

### Criteria A:

Sound transmission from an **adjoining** living or working area:

- minimum demands = 53 dB
- proposal for increased sound protection = 46 dB

### Criteria B:

Sound transmission from **own** living or working area:

- minimum demands = 56 dB
- proposal for increased sound protection = 46 dB

On calculating the evaluated standard impact sound insulating level  $L_n, w, R$ , a correction value of 2 dB has to be considered.

## Impact sound insulation

### Impact sound insulation

The required or requested impact sound insulating level can be calculated with the following calculation scheme:

$$\begin{array}{rcl}
 L_{n, w, eq} & + & \text{dB} \\
 \Delta L_{w, R} & - & \text{dB} \\
 L'_{n, W, R} & = & \text{dB} \\
 \hline
 \text{Correction value} & + & \text{dB} \\
 \hline
 L'_{n, w} & = & \text{dB}
 \end{array}$$

In fact an increased sound protection with a requirement of 46 dB normally can only be fulfilled by soft elastic cover coats.

When using hard (ceramic) covers this value can only be reached by the installation of a sound insulating sublayer.

The planner is responsible for a sufficient impact sound insulation.

Solid cover	Thickness (cm)	12	14	16	18	20
Reinforced concrete plain sheet volume weight = 2300 kg/m <sup>3</sup>	Mass in relation to the surface [kg/m <sup>2</sup> ]	276	322	368	414	460
	L <sub>n,w,eq,R</sub> (equivalent evaluated standard impact sound level)	79	77	75	73	71
Evaluated standard impact sound level L <sub>n,w,R</sub> in dB as per DIN 4109 depending on the dynamic rigidity of the insulation material as per DIN 18165 (MN/m <sup>3</sup> )						
System elements as footfall sound level						
Knob plate FND 35-3	s' ≤ 45, (ΔL <sub>w,R</sub> = 28)	53	51	49	47	45
valufix-Roll 35-3	s' ≤ 10, (ΔL <sub>w,R</sub> = 30)	51	49	47	45	43

Cover coat / floating floor	ΔL <sub>w,R</sub> (VM <sub>R</sub> ) dB	
	With a hard cover coat	With a soft elastic cover coat <sup>1)</sup> ΔL <sub>w,R</sub> m 20 dB (VM <sub>R</sub> m 20 dB)
Floor pavements as per DIN 18560 part 2 <sup>2)</sup> with a mass in relation to the surface of ≤ 70 kg/sq.m on insulation layers of insulation material as per DIN 18165 part 2 with a dynamic rigidity "s" of maximum:		
50 MN/m <sup>3</sup>	22	23
40 MN/m <sup>3</sup>	24	25
30 MN/m <sup>3</sup>	26	27
20 MN/m <sup>3</sup>	28	30
15 MN/m <sup>3</sup>	29	33
10 MN/m <sup>3</sup>	30	34

1) Due to the possible interchangeability of the soft elastic cover coats as per tabel 18, being subject to wear and to special requests of the residents, same may not be taken into account for the proof of demands as per DIN 4109.

2) DIN 18560 part 2, Screed in the building trade screed and heating screed on insulation layers.

# System element TS 30

## Improvement of impact sound insulation

The system element TS 30 is made of polystyrene HR-foam EPS 035 DE0 (PS30SE) and thus has no impact sound insulation improvement.

If an impact sound insulation is required this could be met by the application of specially designed practices.

On using dry screed the application of e.g. Fermacell-screed comb 30 mm is recommended. Manufacturer would provide the values of impact sound insulation improvement.

For wet screed e.g. extruded polyethylene foam 5 mm can be applied. These products are available at the building material trade.

Generally a calculation of heating load acc. to DIN EN 12831 must be provided before laying the underfloor heating with the system elements. The type of screed and surface covering should be known.

Allowance should be made for the most extreme case where floor covering is to be specified later. Similarly where the floor covering is expected to be changed later.

## System element valufix roll 35-3

### System element valufix roll 35-3

#### Characteristics

The aquatherm®-system element valufix roll 35-3 is an effective heat-impact sound insulation system.

Cuts at the rear of the polystyrene insulation roll allow a homogenous close insulation layer after laying.

The cloth-lined covering layer on the upper surface provides a good fixing of the heating pipes by means of pipe clips.

With this type of placing, known as tacker-technique, quick installation times can be achieved. The insulation roll is available in 10.000 mm length and 1.000 mm width.

#### Special advantages

Variable laying distances

Exact placing of heating pipe  
- horizontal and vertical - acc. to DIN EN 1264

No cuttings

Imprinted screen for placing (Division: 50 mm rising)

Well suitable for liquid screed



System element valufix roll 35-3

#### Technical data valufix-roll 35-3

Thermal resistance:  $0.75 \text{ m}^2 \text{ K} / \text{W}$

Dynamic rigidity:  $10 \text{ MN} / \text{m}^3$

Impact sound improv. dimension: 30 dB

max. carrying capacity:  $3.5 \text{ kN} / \text{m}^2$

Insulation size: 35 mm

Art.-No. 91032

Combined with additional insulations the requirements acc. to EnEV can be met.



# System element valufix roll 35-3

## System element valufix-roll 35-3

**Floor detail for heated rooms =**  
Requirements acc. to DIN 4108-4

Height of system insulation in mm	Height additional insulation in mm	Type of screed		
		Cement screed ZE 20	Cement screed ZE 30	Floating screed C A F-F5; F6
		Construction height of screed in mm		
		65 mm	46 mm	51 mm
Total construction height system				
35	-	100 mm	81 mm	86 mm

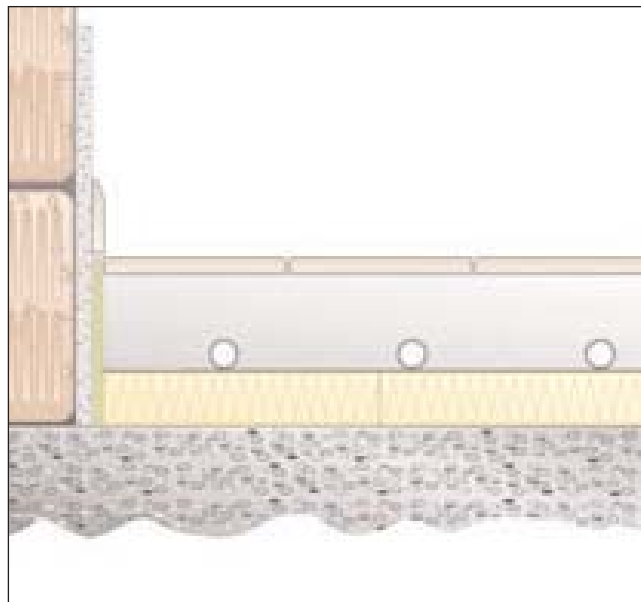

System element valufix-roll 35-3  
Floor detail for heated rooms

**Floor detail for unheated rooms =**  
Requirements acc. to EnEV  
(minimum requirements acc. to EN 1264-4)

Height of system insulation in mm	Height additional insulation in mm	Type of screed		
		Cement screed ZE 20	Cement screed ZE 30	Floating screed C A F-F5; F6
		Construction height of screed in mm		
		65 mm	46 mm	51 mm
Total construction height system				
35	20	120 mm	101 mm	106 mm

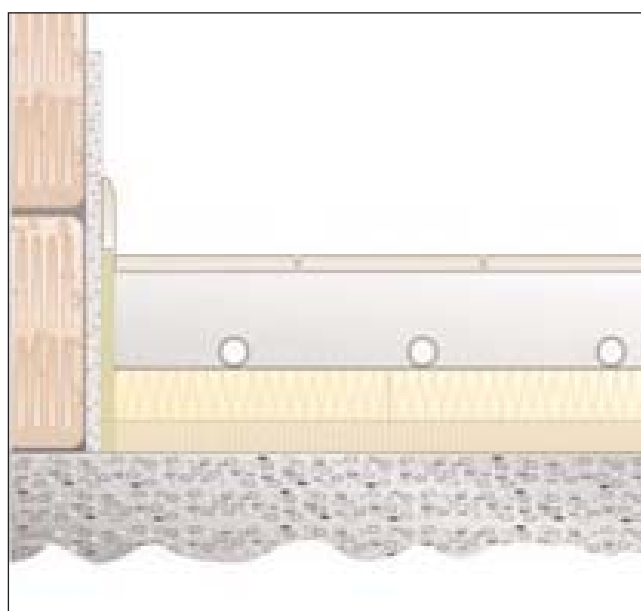

System element valufix-roll 35-3  
Floor detail for unheated rooms

**ADVICE:**

The data base on heating pipes 16 x 2 mm and surface load 2.0 kN / m<sup>2</sup> without covering. Information concerning additional insulation base on EPS-HR-foam DEO resp. DES (WLG 040).

## System element valufix roll 35-3

### System element valufix-roll 35-3

#### Floor detail for ground =

Requirements acc. to EnEV

(minimum requirements acc. to EN 1264-4)

Height of system insulation in mm	Height additional insulation in mm	Type of screed		
		Cement screed ZE 20	Cement screed ZE 30	Floating screed C A F-F5; F6
Construction height of screed in mm				
		65 mm	46 mm	51 mm
Total construction height system				
35	20	120 mm	101 mm	106 mm

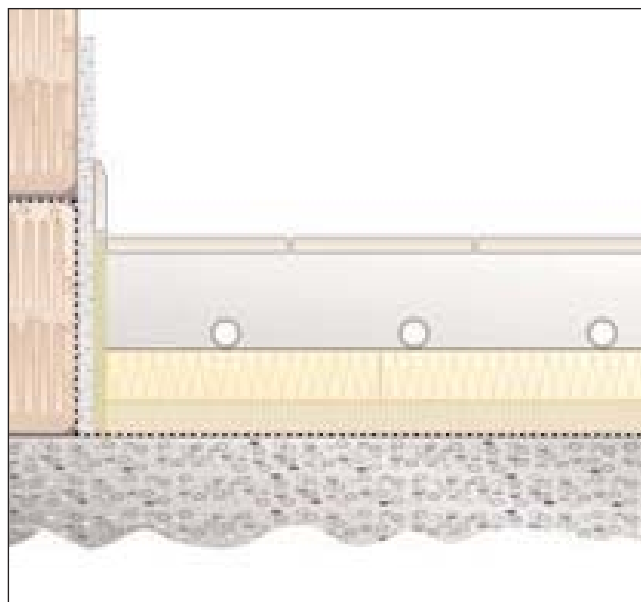

System element valufix-roll 35-3

Floor detail for ground

#### Floor detail for outside air =

Requirements acc. to EnEV

(minimum requirements acc. to EN 1264-4)

Height of system insulation in mm	Height additional insulation in mm	Type of screed		
		Cement screed ZE 20	Cement screed ZE 30	Floating screed C A F-F5; F6
Construction height of screed in mm				
		65 mm	46 mm	51 mm
Total construction height system				
35	50	150 mm	131 mm	136 mm

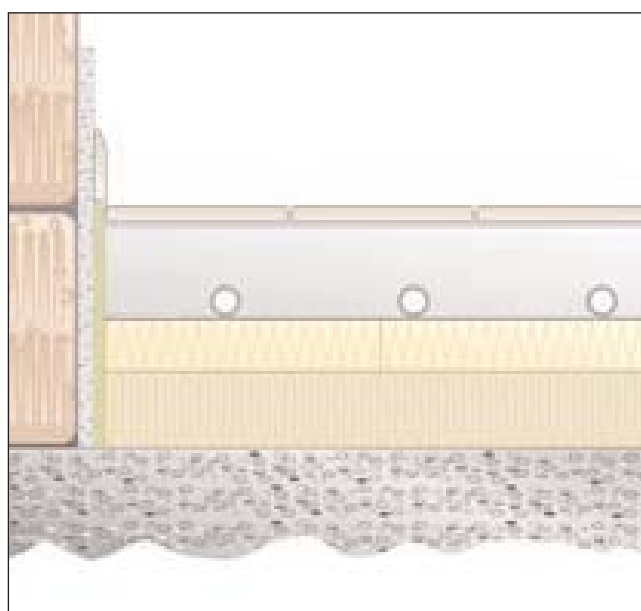

System element valufix-roll 35-3

Floor detail for outside air

#### ADVICE:

The data base on heating pipes 16 x 2 mm and surface load 2.0 kN / m<sup>2</sup> without covering. Information concerning additional insulation base on EPS-HR-foam DEO resp. DES (WLG 040).

# System element valutherm aluminium grid foil

System element  
valutherm aluminium grid foil

## Characteristics

The aquatherm<sup>®</sup>-system element valutherm aluminium grid foil is an aluminium covered coating improving the heat distribution.

The grid coating is placed on commercial insulations. The fabrics at the upper surface effect a close fixing of the heating pipes by means of pipe clips.

The self-adhesive profile rails are also applicable.

The grid foil has to be laid with an overlapping of at least 80 mm and fixed with plastic nails or by pasting up the linings.

## Special advantages

Variable laying distances

Exact placing of heating pipe  
- horizontal and vertical - acc. to DIN EN 1264

Applicable on all commercial high resistance  
foam insulations

No cuttings

Imprinted screen for placing (Division: 50 mm rising)

Well suitable for liquid screed



valutherm aluminium grid foil

### Technical data valutherm aluminium grid foil

Length: 50.000 mm

Width: 1.080 mm

Overlapping: 80 mm

Packing unit: 50 m<sup>2</sup>

Screen-Printing: 50 / 100 mm

Art.-No. 91010

## System element valutherm aluminium grid foil

System element valutherm aluminium grid foil

**Intermediate floor with heated lower rooms =**  
Requirements acc. to DIN 4108-4

Height of system insulation in mm	Height additional insulation in mm	Type of screed		
		Cement screed ZE 20	Cement screed ZE 30	Floating screed C A F-F5; F6
Construction height of screed in mm				
		65 mm	46 mm	51 mm
Total construction height system				
-	30*	95 mm	76 mm	81 mm

\* = EPS-DES (WLG 040)

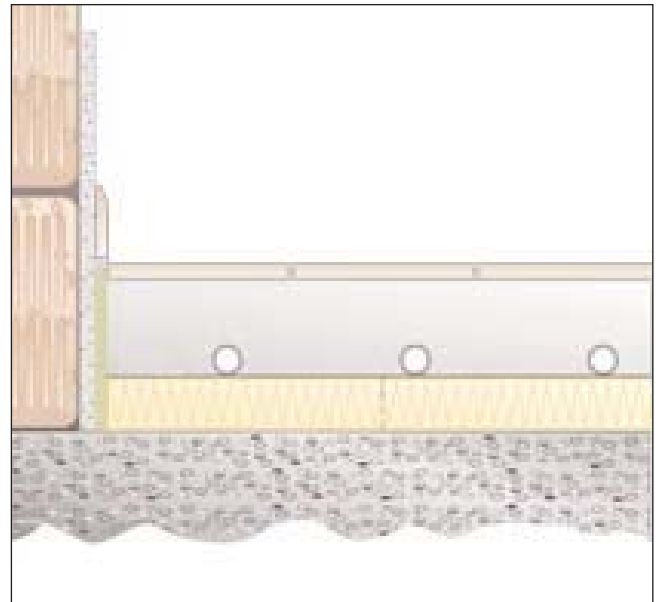

System element valutherm aluminium grid foil  
Floor detail for heated rooms

**Floor detail for unheated rooms =**  
Requirements acc. to EnEV  
(minimum requirements acc. to EN 1264-4)

Height of system insulation in mm	Height additional insulation in mm	Type of screed		
		Cement screed ZE 20	Cement screed ZE 30	Floating screed C A F-F5; F6
Construction height of screed in mm				
		65 mm	46 mm	51 mm
Total construction height system				
-	50*	115 mm	96 mm	101 mm

\* = EPS-DEO (WLG 040)

### ADVICE:

The data base on heating pipes 16 x 2 mm and surface load 2.0 kN / m<sup>2</sup> without covering. Information concerning additional insulation base on EPS-HR-foam DEO resp. DES (WLG 040).

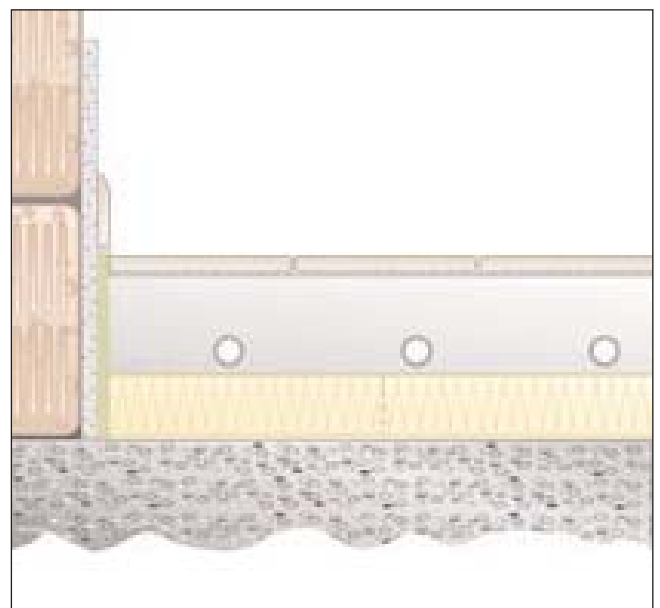

System element valutherm aluminium grid foil  
Floor detail for unheated rooms

# System element valutherm aluminium grid foil

System element valutherm aluminium grid foil

**Floor detail for ground =**

Requirements acc. to EnEV

(minimum requirements acc. to EN 1264-4)

Height of system insulation in mm	Height additional insulation in mm	Type of screed		
		Cement screed ZE 20	Cement screed ZE 30	Floating screed C A F-F5; F6
Construction height of screed in mm				
		65 mm	46 mm	55 mm
Total construction height system				
-	50*	115 mm	96 mm	105 mm

\* = EPS-DEO (WLG 040)

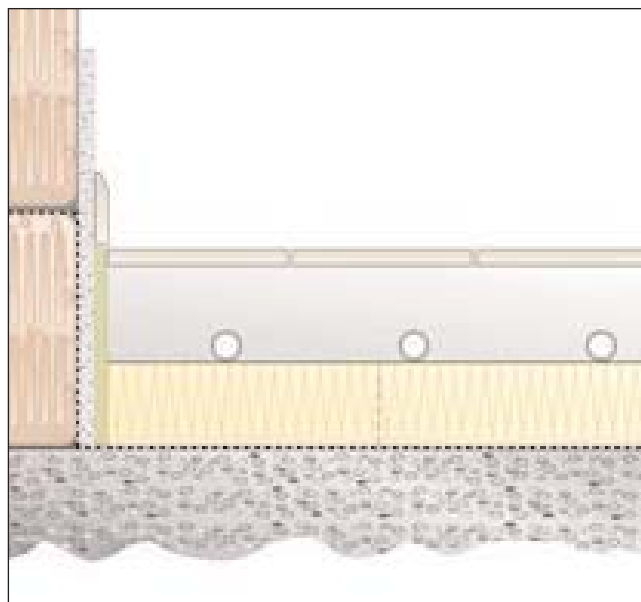

System element valutherm aluminium grid foil  
Floor detail for ground

**Floor detail for outside air =**

Requirements acc. to EnEV

(minimum requirements acc. to EN 1264-4)

Height of system insulation in mm	Height additional insulation in mm	Type of screed		
		Cement screed ZE 20	Cement screed ZE 30	Floating screed C A F-F5; F6
Construction height of screed in mm				
		65 mm	46 mm	51 mm
Total construction height system				
-	80*	145 mm	126 mm	131 mm

\* = EPS-DEO (WLG 040)

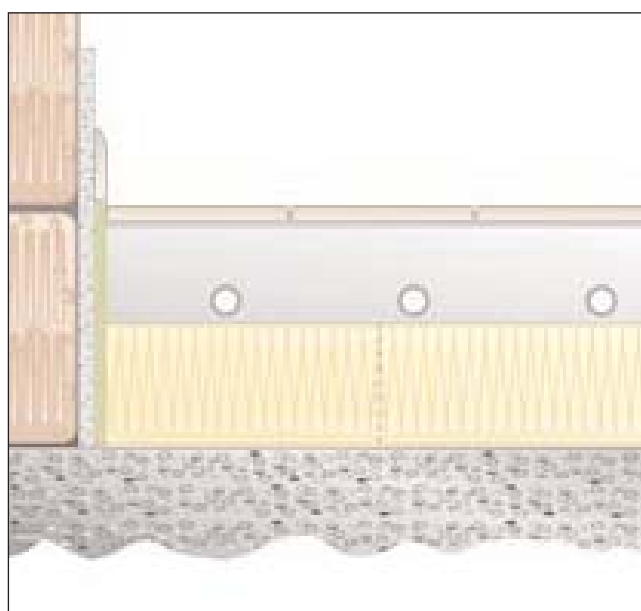

System element valutherm aluminium grid foil  
Floor detail for outside air

**ADVICE:**

The data base on heating pipes 16 x 2 mm and surface load 2.0 kN / m<sup>2</sup> without covering. Information concerning additional insulation base on EPS-HR-foam DEO resp. DES (WLG 040).

## Accessories for valufix- and valutherm systems

Accessories for valufix- and valutherm systems

aquatherm®-Pipe clip

### Characteristics

aquatherm®-valufix- and valutherm-Systems are equipped with a proven woven cloth. The pipe clip is pressed over the heating pipes, through the body ply into the insulation.

The barbs of the pipe clip brace in the cloth and keep the aquatherm®-floor heating pipes.



Pipe clip

### Technical data aquatherm®-pipe clip

Material: Polyamide

Dimension: 14-17 mm

**Art.-No. 90504**

Material: Polyamide

Dimension: 20 mm

**Art.-No. 90505**

aquatherm®-Tackfix-tacker

### Characteristics

aquatherm®-pipe clips for the tacker are supplied in 25 piece magazines with self adhesive tape.

After filling the tackfix-tacker with pipe clips, the placing is preferably made by 2 installers to reach shortest placing times.



Tackfix-tacker

## Accessories for valufix- and valutherm systems

### aquatherm®-Profile rail

#### Characteristics

With the aquatherm®-profile rail (alternative to tacker-technique) the floor heating pipes can be fixed on the insulation.

The profile rail is provided with a self-adhesive tape at the bottom side effecting its safe fixing.

Quick assembly-times are guaranteed due to rated break points, at which the rail can be cut without additional tools. Pipes can be divided into 50 mm distances.

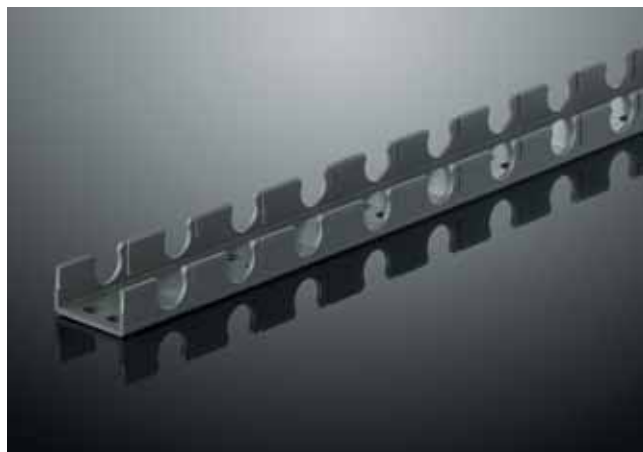

Profile rail

#### Technical data profile rail

Length: 2000 mm

Material: Polyamide

Pipe distance: 50 mm

Dimension 14 mm	Art.-No. 90515
Dimension 16 mm	Art.-No. 90517
Dimension 20 mm	Art.-No. 90518

### aquatherm®-Self adhesive tape

#### Characteristics

The aquatherm®-self adhesive tape closes the gaps at the joints of the valufix- and valutherm-elements.

The gluing is made by means of a commercial manual dispenser and should be made directly after placing of the insulation elements.



Self adhesive tape

#### Technical data self adhesive tape

Length: 66 m

Width: 50 mm

Art.-No. 91104

## System element knob plate F ND 35-3

System element knob plate F ND 35-3

### Characteristics

The aquatherm®-system element knob plate F ND35-3 is made of polystyrene high resistance foam with integrated pipe keeping knobs.

The surface is refined with PS-foil and has overlays.

The knobs are safe and keep the heating pipes perfectly.

The element has a sound insulation at its under side.

The element is suitable for heating pipes of dimension 14 x 2.0 mm or 16 x 2.0 mm.

### Special advantages

Variable pipe spacings in 50 mm grid

Ideal for liquid screed due to special overlapping

Good heat efficiency due to complete pipe integration

One-man-placing without problems

Easy assembly without special tools

Exact placing of heating pipe  
- horizontal and vertical - conform to DIN EN 1264

Diagonal laying also possible

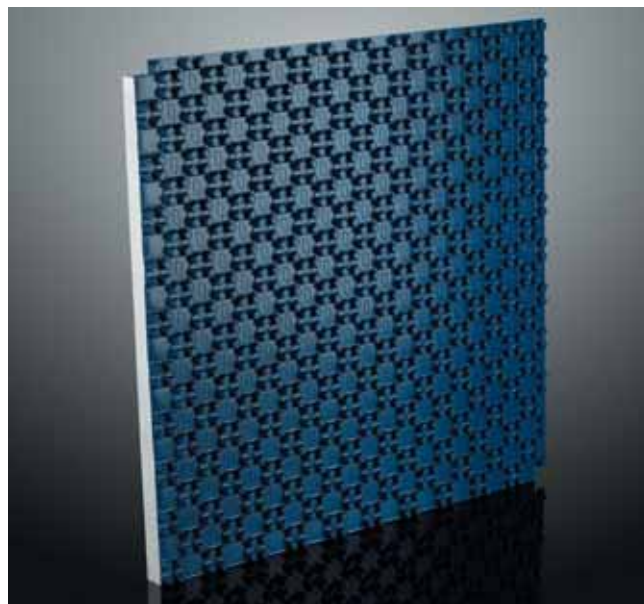

System element knob plate F ND 35-3

### Technical Data knob plate F ND 35-3

Thermal resistance:  $0.77 \text{ m}^2 \text{ K} / \text{W}$

Insulation size: 35 mm

Total size inclusive pipe holding knobs: 53 mm

Max. working load:  $3.5 \text{ kN} / \text{m}^2$

Impact sound improvement size: 28 dB

**Art.-No. 91115**

In combination with additional insulation material the requirements of EnEV can be met.



# System element knob plate F ND 35-3

System element knob plate  
F ND 35-3

**Intermediate floor with heated lower rooms =**  
Requirements acc. DIN 4108-4

Height of system insulation in mm	Height additional insulation in mm	Type of screed		
		Cement screed ZE 20	Cement screed ZE 30	Floating screed C A F-F5; F6
Construction height of screed in mm				
		65 mm	46 mm	51 mm
Total construction height system				
35	-	100 mm	81 mm	86 mm

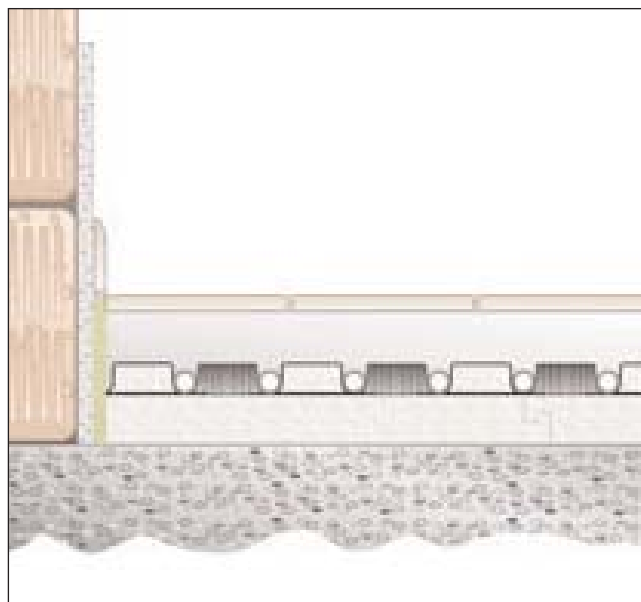

System element knob plate F ND 35-3  
Floor detail for heated rooms

**Floor detail for unheated rooms =**  
Requirements acc. to EnEV  
(minimum requirements acc. to EN 1264-4)

Height of system insulation in mm	Height additional insulation in mm	Type of screed		
		Cement screed ZE 20	Cement screed ZE 30	Floating screed C A F-F5; F6
Construction height of screed in mm				
		65 mm	46 mm	51 mm
Total construction height system				
35	20	120 mm	101 mm	106 mm

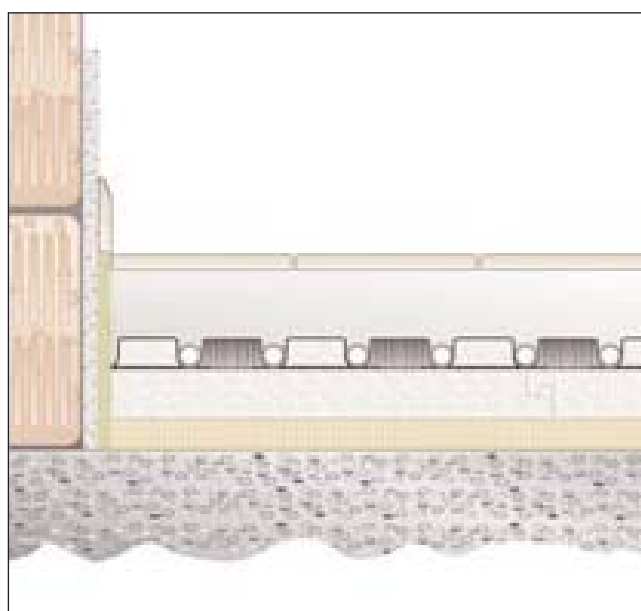

System element knob plate F ND 35-3  
Floor detail for unheated rooms

**ADVICE:**

The data base on heating pipes 16 x 2 mm and surface load 2.0 kN / m<sup>2</sup> without covering. Information concerning additional insulation base on EPS-HR-foam DEO resp. DES (WLG 040).

## System element knob plate F ND 35-3

System element knob plate F ND 35-3

### Floor detail for ground =

Requirements acc. to EnEV

(minimum requirements acc. to EN 1264-4)

Height of system insulation in mm	Height additional insulation in mm	Type of screed		
		Cement screed ZE 20	Cement screed ZE 30	Floating screed C A F-F5; F6
Construction height of screed in mm				
		65 mm	46 mm	51 mm
Total construction height system				
35	20	120 mm	101 mm	106 mm

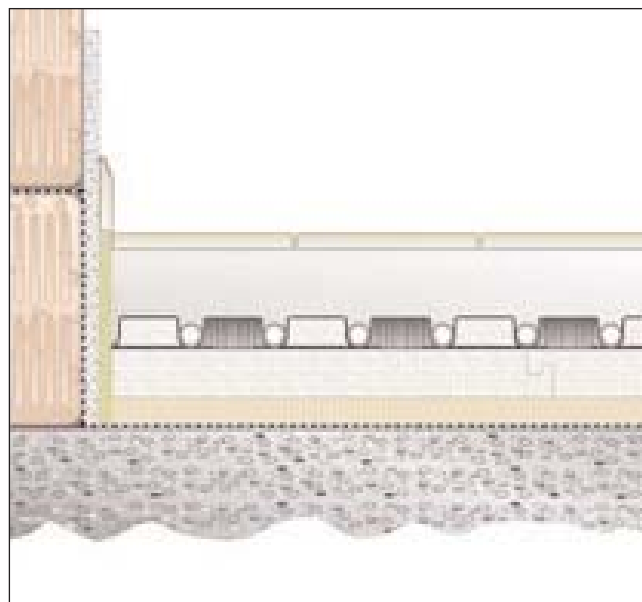

System element knob plate F ND 35-3  
Floor detail for ground

### Floor detail for outside air =

Requirements acc. to EnEV

(minimum requirement acc.to EN 1264-4)

Height of system insulation in mm	Height additional insulation in mm	Type of screed		
		Cement screed ZE 20	Cement screed ZE 30	Floating screed C A F-F5; F6
Construction height of screed in mm				
		65 mm	46 mm	51 mm
Total construction height system				
35	50	150 mm	131 mm	136 mm

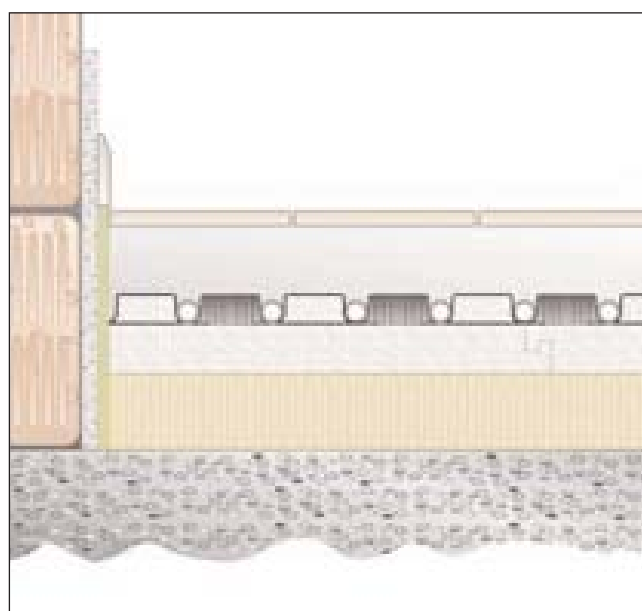

System element knob plate F ND 35-3  
Floor detail for outside air

### ADVICE:

The data base on heating pipes 16 x 2 mm and surface load 2.0 kN / m<sup>2</sup> without covering. Information concerning additional insulation base on EPS-HR-foam DEO resp. DES (WLG 040).

# System element knob plate F ND 11

## System element knob plate F ND 11

### Characteristics

The aquatherm®-system element knob plate F ND 11 is made of polystyrene high resistance foam with integrated pipe keeping knobs.

The surface is refined with PS-foil and has overlays. The knobs are safe and keep the heating pipes in place. The element is equipped with 11 mm polystyrene high resistance foam EPS 200 at its underside.

There is a choice of 14 x 2.0 mm or 16 x 2.0 mm for the heating pipes which can be placed.

### Special advantages

Variable pipe distances in 50 mm grid

Ideal for liquid screed due to folded joints on all sides and accessories

Good heat efficiency due to complete pipe integration

One-man-installation without problems

Easy assembly without special tools

Exact placing of heating pipe  
- horizontal and vertical - conform to DIN EN 1264

Applicable for all commercial high resistance foam insulations

Diagonal laying is also possible

On using "Lazenoflex-floor system" it is possible to achieve in smallest layer size a heated floor construction with pipes on the insulation (building type A1) in the field of reconstruction and renovation.

→ The construction height above the heating pipes is only about 10 mm (without covering)

→ Total construction height about 45 mm

→ Covering materials like tiles, bricks, terracotta, clinker pavement are suitable



System element knob plate F ND 11

### Technical Data knob plate F ND 11

Thermal resistance: 0.31 m<sup>2</sup>K / W

Insulation size: 11 mm

Total size inclusive pipe holding knobs: 29 mm

Max. working load: 30.0 kN / m<sup>2</sup>

Impact sound improvement size: without

**Art.-No. 91112**

In combination with additional insulation material the requirements of EnEV can be met.

## System element knob plate F ND 1 1

System element  
knob plate F ND 1 1

**Intermediate floor with heated lower rooms =**  
Requirements acc. to DIN 4108-4

Height of system insulation in mm	Height additional insulation* in mm	Type of screed		
		Cement screed ZE 20	Cement screed ZE 30	Floating screed C A F-F5; F6
Construction height of screed in mm				
		65 mm	46 mm	51 mm
Total construction height system				
11	20	96 mm	77 mm	82 mm

\*=minimum requirement



System element knob plate F ND 11  
Floor detail for heated rooms

**Floor detail for unheated rooms =**  
Requirements acc. to EnEV  
(minimum requirement acc.to EN 1264-4)

Height of system insulation in mm	Height additional insulation in mm	Type of screed		
		Cement screed ZE 20	Cement screed ZE 30	floating screed C A F-F5; F6
Construction height of screed in mm				
		65 mm	46 mm	51 mm
Total construction height system				
11	40	116 mm	97 mm	101 mm

### ADVICE:

The data base on heating pipes 16 x 2 mm and surface load 2.0 kN / m<sup>2</sup> without covering. Information concerning additional insulation base on EPS-HR-foam DEO resp. DES (VLG 040).

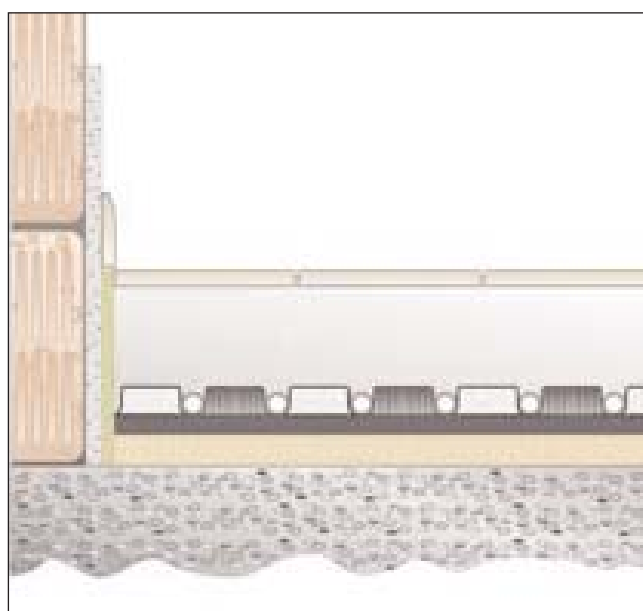

System element knob plate F ND 11  
Floor detail for unheated rooms

# System element knob plate F ND 1 1

System element knob plate F ND 1 1

**Floor detail for ground=**

Requirements acc. to EnEV  
(minimum requirement acc. to EN 1264-4)

Height of system insulation in mm	Height additional insulation in mm	Type of screed		
		Cement screed ZE 20	Cement screed ZE 30	Floating screed C A F-F5; F6
		Construction height of screed in mm		
		65 mm	46 mm	51 mm
Total construction height system				
11	40	116 mm	97 mm	101 mm

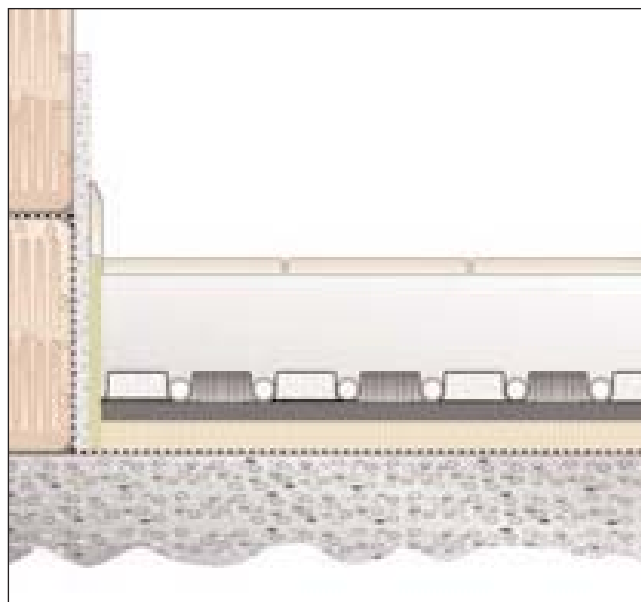

System element knob plate F ND 11  
Floor detail for ground

**Floor detail for outside air =**

Requirements acc. to EnEV  
(minimum requirements acc. to EN 1264-4)

Height of system insulation in mm	Height additional insulation in mm	Type of screed		
		Cement screed ZE 20	Cement screed ZE 30	Floating screed C A F-F5; F6
		Construction height of screed in mm		
		65 mm	46 mm	51 mm
Total construction height system				
11	70	146 mm	127 mm	132 mm

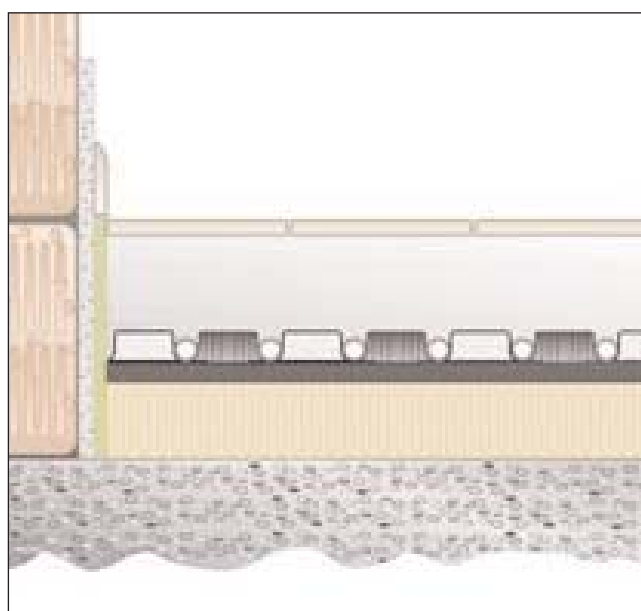

System element knob plate F ND 11  
Floor detail for outside air

**ADVICE:**

The data base on heating pipes 16 x 2 mm and surface load 2.0 kN/m<sup>2</sup> without covering. Information concerning additional insulation base on EPS-HR-foam DEO resp. DES (WLG 040).

## System element knob plate F ND 11

System element knob plate F ND 11

### Intermediate floor:

System element knob plate F ND 11 with thin layer screed or laying mortar

Additional insulation required for meeting the demands of EnEV or DIN 4109 is not considered in the following table.

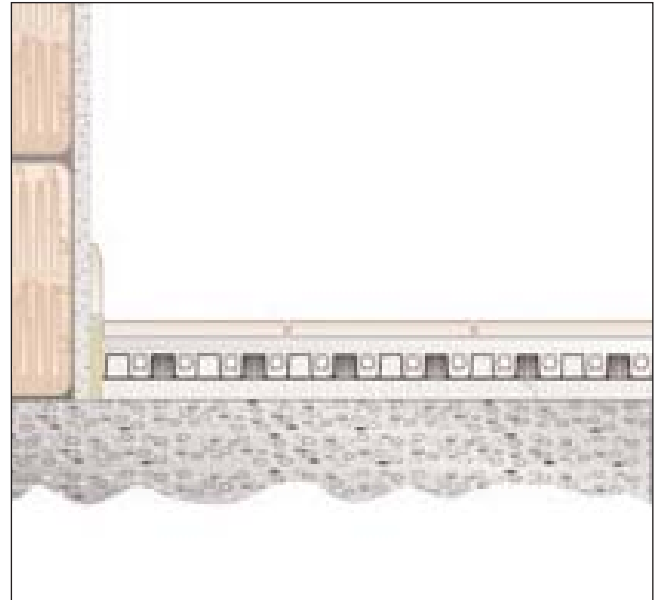

System element knob plate F ND 11  
Intermediate floor

Height of system insulation in mm	Type of screed		Laying mortar
		Cement screed ZE 30	Floating screed C A F-F5; F6
	Construction height of screed in mm		Height of mortar in mm
	46 mm	51 mm	8 mm
	Total construction height system		
11/29	57 mm	62 mm	37 mm*

\* = only in connection with ceramic tiles suitable

# System element TS 30

## System element TS 30

### Characteristics

The aquatherm<sup>®</sup>-system element TS 30 is made of polystyrene high resistance foam EPS 035 DEO (PS 30 SE) with integrated pipe channels.

These pipe channels are equipped with heat conducting steel sheet to improve the heat distribution and to fix the elements. The still integrated pipe channel in the bottom area can be used for passing connection supplies.

The system element is applied e.g. in areas where customary wet construction systems are not applicable.

Therefore the ideal alternative for refurbishment of old buildings which cannot take the normal admissible weight of approx. 130 - 150 kg / m<sup>2</sup>.

The usual floor drying time can be renounced on using dry floors also in the field of prefabricated houses.



System element TS 30

Technical Data System element TS 30
Thermal resistance: 0.75 m <sup>2</sup> K / W
Insulation size: 30 mm
Max. working load: 7.5 kN / m <sup>2</sup>
Impact sound improvement size: without
<b>Art.-No. 91039</b>
<b>Art.-No. 91041</b>

In combination with additional insulation material the requirements of the EnEV can be met.

## Systemelement TS 30

### System element TS 30

**Intermediate floor with heated lower rooms =**  
Requirements acc. to DIN 4108-4

Height of system insulation in mm*	Height additional insulation in mm	Type of screed		
		Cement screed ZE 20	Cement screed ZE 30	Floating screed C A F-F5; F6
Construction height of screed in mm				
		45 mm	30 mm	35 mm
Total construction height system				
30	-	75 mm	60 mm	65 mm

\* = additional impact soundinsulation may change the construction height



System element TS 30  
Intermediate floor with heated lower rooms

**Floor detail for unheated rooms =**  
Requirements acc. to EnEV  
(minimum requirements acc. to EN 1264-4)

Height of system insulation in mm	Height additional insulation in mm	Type of screed		
		Cement screed ZE 20	Cement screed ZE 30	Floating screed C A F-F5; F6
Construction height of screed in mm				
		45 mm	30 mm	35 mm
Total construction height system				
30	20	95 mm	80 mm	85 mm

#### ADVICE:

The data base on heating pipes 16 x 2 mm and surface load 2.0 kN/m<sup>2</sup> without covering. Information concerning additional insulation base on EPS-HR-foam DEO resp. DES (WLG 040).

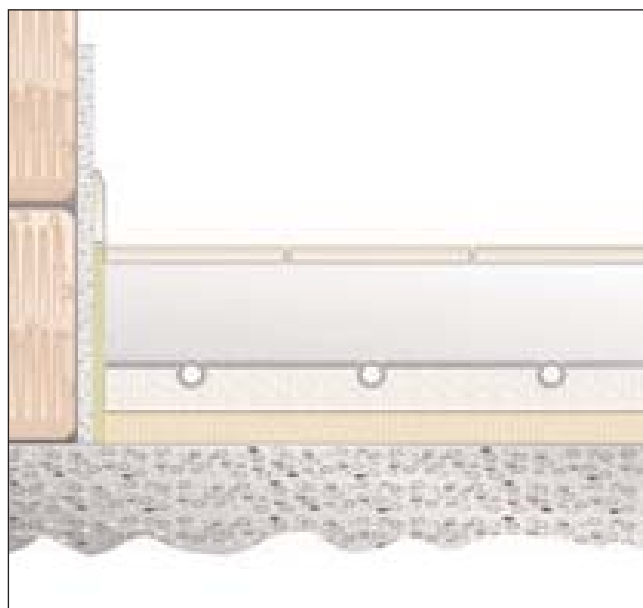

System element TS 30  
Floor detail for unheated rooms



# Systemelement TS 30

## System element TS 30

### Floor detail for ground =

Requirements acc. to DIN 4108-4

Height of system insulation in mm *	Height additional insulation in mm	Type of screed		
		Cement screed ZE 20	Cement screed ZE 30	Floating screed C A F-F5; F6
		Construction height of screed in mm		
		45 mm	30 mm	35 mm
Total construction height system				
30	20	95 mm	80 mm	85 mm

\* = additional impact soundinsulation may change the construction height

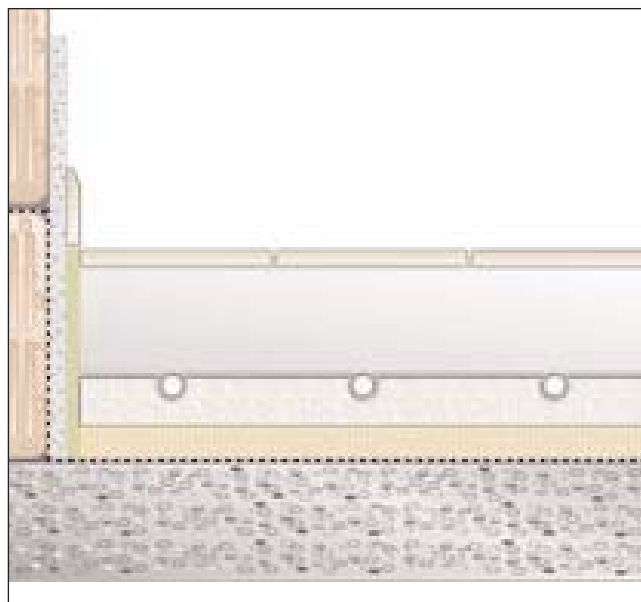

System element TS 30  
Floor detail for ground

### Floor detail for outside air =

Requirements acc. to EnEV

(minimum requirements acc. to EN 1264-4)

Height of system insulation in mm	Height additional insulation in mm	Type of screed		
		Cement screed ZE 20	Cement screed ZE 30	Floating screed C A F-F5; F6
		Construction height of screed in mm		
		45 mm	30 mm	35 mm
Total construction height system				
30	50	125 mm	110 mm	115 mm

### ADVICE:

The data base on heating pipes 16 x 2 mm and surface load 2.0 kN/m<sup>2</sup> without covering. Information concerning additional insulation base on EPS-HR-foam DEO resp. DES (WLG 040).

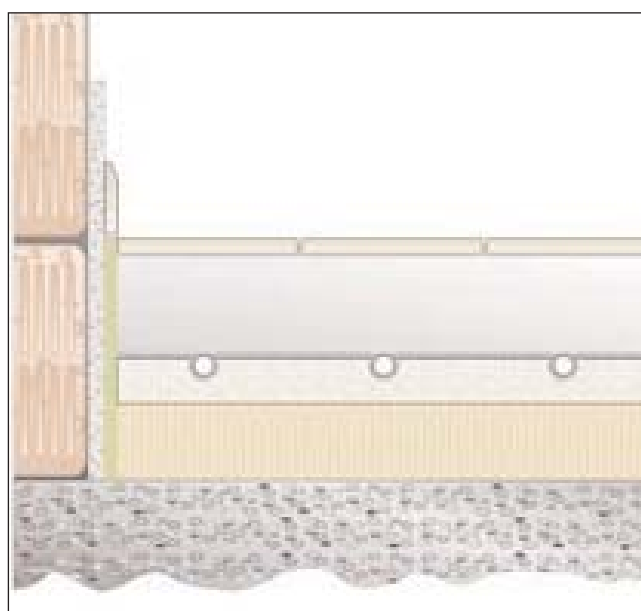

System element TS 30  
Floor detail for outside air

## Additional insulating material

### aquatherm®-Additional insulating material

#### Characteristics

After introduction of the Energy Saving Regulation (EnEV) on the 01.02.2002 a minimum heat protection acc. to DIN EN 1264, part 4 for hot water under floor heating systems is effective in the European countries.

This standard stipulates a minimum thermal resistance of insulating material of  $R_{\lambda}=1.25 \text{ m}^2\text{K} / \text{W}$  for ceilings against ground and ceilings against unheated rooms.

For ceilings against outside air a minimum thermal resistance of  $R_{\lambda}=2.0 \text{ m}^2\text{K} / \text{W}$  is demanded.

These requirements to the minimum heat protection can be met with the aquatherm® system element in connection with additional insulating material made of polystyrene high resistance foam EPS DEO.



Additional insulating material

Technical data aquatherm®-additional insulating material
Thermal conductivity: 0.04 W / mK
Max. working load: 20.0 kN / m <sup>2</sup>
Length: 1000 mm
Width: 500 mm
Height: 20 mm
<b>Art.-No. 91046</b>

# aquatherm<sup>®</sup>-Edge insulation

## aquatherm<sup>®</sup>-Edge insulation

### Characteristics

The aquatherm<sup>®</sup>-edge insulation is placed at all external areas.

There is an absorption layer for the heat expansion of the heated floor and a separation layer between flooring and mounting components, as well as impact sound insulation and heat insulation layer between the components.

Edge insulation must allow an expansion of cement floor up to 5 mm.

According to the requirements of the DIN 18560 excess edge insulation can only be removed after installation of the floor coverings.



Edge insulation

### Special advantages

Material:

Polyethylene foam 8 mm thick, 160 mm height

Perforated tear-off strip for different heights of cement floor

Gummed tape at the backside for fixing to brickwork

Welded PE-foil with adhesive strip

Very low flammability

#### Technical data edge insulation

Length: 25 mm

Height: 160 mm

Width: 8 mm

Art.-No. 91106

## aquatherm<sup>®</sup>-Expansion joint section

### aquatherm<sup>®</sup>-Expansion joint section

#### Characteristics

The formation of expansion joints e.g. in door areas causes considerable problems to the flooring paver as the connection supplies to the heating circuits cross the joint.

The perfect execution of an expansion joint can easily be done with the aquatherm<sup>®</sup>-expansion joint section.

In accordance with DIN 18560 T2 it is required, that cement floor has to expand 5 mm to all directions.

Thus it is important to install expansion joint sections in door passages and between large areas of cement floor. These joints have to separate the cement floor in its total thickness up to the insulation.



Expansion joint section

#### Technical data expansion joint section

Length: 2.000 mm

Height (PE-strips): 100 mm

Thickness (PE-strips): 8 mm

**Art.-No. 91107**

**PE-corrugated pipe**

Length: 10 m

**Art.-No. 91111**

# Expansion joint section

## aquatherm®-Expansion joint section

### Characteristics

The profile rail with joint profile is cut into a suitable length and adhered to the system element.

Openings in the profile rail for the common pipe distances starting from a spacing of 50 mm.

After placing the heating pipes through the profile rail the expansion strip is placed on the pipes and the passage of the heating pipes is marked with a felt-tip pencil.

The holes have to be punched with a diameter of approx. 25 mm. The remaining web below the punched holes is cut. The protection pipes are pushed over the heating pipes in the moving area.

Finally the expansion strip is pressed over the heating pipes into the channel of the profile rail.

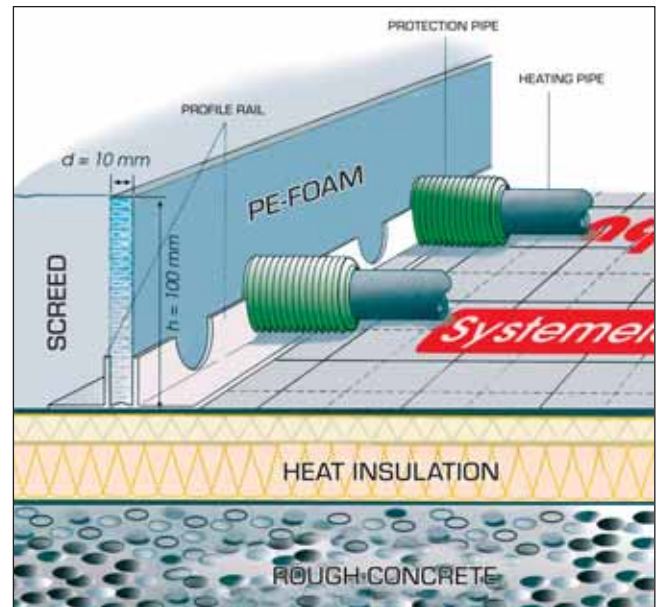

### Special advantages

Larger surfaces can be divided without any problem into several partial surfaces with the aquatherm expansion joint section, if the position of the profile has been coordinated with the modular dimension of the tiles.

Further information concerning "joints" is available in leaflets of the Central Association of the German Building Trade.

# Screeds

## Screed

The screed is used as a load distributing and load-carrying layer. Screeds for under floor heating must be characterize by the following:

- ▣ high temperature resistance
- ▣ high surface strength
- ▣ high thermal conductivity

Screeds on aquatherm<sup>®</sup>-under floor heating systems must correspond to the requirements of DIN 18560.

The respective strength class is determined by the architect considering the later use.

For normal residential buildings at least cement screeds (CT) resp. floating screeds (CAF) of class F4 / F5, F6 up to a working load of  $\leq 2.0 \text{ kN} / \text{m}^2$  have to be used.

The necessary screed thickness depending on the load can be taken from the tables 1-4 of DIN 18560 T2.

## Cement screed (CT) / screed additive

For the aquatherm<sup>®</sup>-under floor heating in connection with cement screed, made according to DIN 18560, the screed additive "aquatherm floor mix" is prescribed. This material has been tested in connection with the basic and additional materials of the screed.

The screed additive aquatherm<sup>®</sup>-"Special floor mix" is prescribed for thin-layer cement floor as per DIN 18560.

## Liquid screed (CA)

Placing of liquid screed is made without extensive compaction and distribution works. The basic materials mostly are anhydrite with addition of solvents.

As these screeds are placed in a liquid form directly on site an all-over closed surface is absolutely required.

## Calcium-sulphate liquid screed (CAF)

Calcium-sulphate liquid screed is made of anhydrite plaster, water and additional materials.

The indications of the respective manufacturer have to be considered for suitability and handling.

## Poured asphalt screed (AS)

Poured asphalt screed is made of bitumen and if necessary by adding of additional materials. The mixture is placed with temperatures of approx.  $220^\circ \text{C} - 250^\circ \text{C}$ .

Poured asphalt screeds are not suitable for aquatherm<sup>®</sup>-under floor heating systems.

# Screed additive floor mix

## aquatherm®-Screed additive floor mix

### Characteristics

aquatherm®-floor mix is a highly efficient screed additive developed especially for heating cement floor.

Cement floors for heated floor constructions do not differ regarding their mortar composition, their mechanical preparation and the required consistency from "normal" floating laid cement floors acc. to DIN 18560, part 2.

For heated floor constructions it must be ensured, that the standard requirements for cement floors under installation condition are actually met.

The fresh cement mortar must cover the heating pipes completely and may not affect the installed materials.

aquatherm®-floor mix reduces the surface tension of the mixing water resulting in a better mixing of the fine grained binding agent. The result is a homogenous cement floor mortar, easy to handle, which surrounds the heating pipes completely.

The volume of mixing water is reduced by adding of aquatherm floor mix. A reduction of the water cement value (with constant mortar consistence) results in an increase of the density of the hardened floor.

By raising the density of the load distributing cement floor plate an improvement of the thermal conductivity as well as increasing heat accumulation capability are obtained.

The characteristics of fresh screed achieved by floor mix effect an increase of bending tensile and pressure stresses.

The capacity of air voids is not increased. With the aquatherm floor mix a high retaining water value of the fresh screed is achieved, that means no water separation at the cement floor surface and a reduced contraction.



Screed additive floor mix

### Dosage

aquatherm®-floor mix must be added in a percentage of 1% of the cement weight for the completion of cement floor screed, e.g. 0.5 kg floor mix.

Add floor mix directly to the mixing water.

Proportion for cement floor thickness of 6.5 cm is approx. 0.2 kg/m<sup>2</sup>.

No further additives should be added to the aquatherm® floor mix.

The addition of Estro-synthetic fibre to the fresh cement mortar can replace floor grids.

#### Technical data floor mix

Proportion: approx. 0.2 kg / m<sup>2</sup>

Art.-No. 91108

## Special floor mix

### aquatherm®-Special floor mix

#### Characteristics

aquatherm®-special floor mix is a very efficient floor screed additive for the preparation of thin-layer and cement connected heating screed according to DIN 18560. This additive is applied for cement screeds placed on underfloor heating systems - but only in the minimum rigidity classification ZE 30.

The nominal thickness of floor screed above the heating pipes can be reduced to 30 mm on applying Special floor mix. Due to its high density and consistency the mixture of cement floor screed and Special floor mix meets all required functions of a load distributing plate, even with reduced thickness.

aquatherm®-special floor mix effects a substantial increase of bending tensile and pressure stress. The max. value for bending of 0.15 mm, required by DIN 18560 T2, favourably remains under.

By using this additive the cement mortar is more compressible, less mixed water is required and the result is a homogeneous structure. These characteristics of the fresh screed cause a better mixture of the fine-grained cement, a. o. by lowering the surface tension of the water. Increasing the apparent density by adding of aquatherm®-special floor mix effects also an increase of the thermal conductivity of the screed.

Handling, composition, preparation and curing have to be carried out acc. to DIN 18560, Part 2, Screeds and heat screeds on insulation layers. The aggregate (grave / sand 0 / 8 mm) must correspond to DIN 4226 "Aggregate for Concrete" with regard to its structure (a.o. grain solidity) and the grain composition of the floor aggregate to DIN 1045 "Concrete and reinforced concrete".

Processing does not differ from the previously known usual workmanship as customary machines for mixing and transport are also applied.



Screed additive "Special floor mix"

#### Technical data special floor mix

Proportion: approx. 1.45 kg / m<sup>2</sup>

Art.-No. 91110



## Dosage

By mixing the cement floor screed aquatherm®-Special floor mix in a percentage of 10 % of the cement weight has to be added, this corresponds to 5 kg for every 50 kg cement.

Add aquatherm® Special floor mix directly to the first mixing water.

The following example offers the data for the required amount of Special floor mix for the preparation of a screed acc. to rigidity class ZE30:

**Operational use of 320 kg cement / m<sup>3</sup>  
32 kg Special floor mix / m<sup>3</sup>.**

That corresponds for 1 m<sup>2</sup> screed surface to approx. 320 g Special floor mix per cm of floor thickness. For a floor covering of 30 mm (total thickness of the screed approx 45 mm) a quantity of 1.45 kg / m<sup>2</sup> is required.

## Processing

The floor consistency upon delivery has to be stiff when using "factory-fresh mortar". Special floor mix is added on site, directly into the mixer. A remixing time of approx. 10 min is necessary in any case in order to utilize the effect of Special floor mix completely. If a concrete retarder should be added to the factory-fresh mortar, a consultation of the aquatherm technicians will be essential.

No further additives may be mixed to the screed. Floor mortars may not be used below + 5° C acc. to DIN 18560, Part 1. As the additional competent placement of e.g. a floor grid as reinforcement for thin-layers floors is rather hard to handle, it is recommended to add floor synthetic fibres to the fresh mortar (demand for product information).

Screeds must be heated before placement of floor coverings. Initial operation has to be done according to the aquatherm installation instructions.

Inherent colour: pink

## Screed measuring point

aquatherm®-Screed measuring point

### Characteristics

Cement and anhydrite screeds must be heated prior to placing of floor coverings acc. to DIN EN 1264.

Suitable measuring points in the heating area are necessary for determination of the content of humidity. At least 3 measuring points per each 200 m<sup>2</sup> resp. per flat are required.

Detailed information regarding the heating on page Heat-up of screed!

### Important intersecting points

#### Planning: Planner Heating / Architects

The planner - in coordination with the architect - determines the number and position of the intersection points in the plan.

If no planner is involved, the client or his desputy takes on the task.

#### Design: Screed layer

The screed layer installs the intersecting points acc. to the plans.

#### Measuring: Chief of the covering placing

The measuring is carried out by means of a CM-device before placing the covering

### Important!

The minimum distance between heating pipe and intersection point is 100 mm.



Screed measuring point

#### Technical data aquatherm®-screed measuring point

Height:	100 mm
---------	--------

Art.-No.	91109
----------	-------

## Screed fields / Edge gaps

### Screed fields

In case of non-rectangular floor surfaces or covered surfaces the required expansion joints have to be arranged in such a way that possibly cramped fields result.

The thermally caused change of length of the cement screed amounts to approx. 0.012 mm / mK.

Taking up of pressure and tensile stress can only be achieved by correctly planned and installed expansion joints and screed fields. The planner of the building has to issue a joint plan regarding the arrangement of joints which has to be presented to the executing party as part of the performance description.

### Edge Gaps

Edge gaps take up thermally caused changes of length of the screed and floor coverings. They reduce the impact sound transmission from the floor to other components.

Edge gaps must enable a movement space of at least 5 mm. The edge insulation in the edge gap may only be cut after completion of the floor covering.

Subsequently the edge gaps have to be filled with an elastic joint seal.

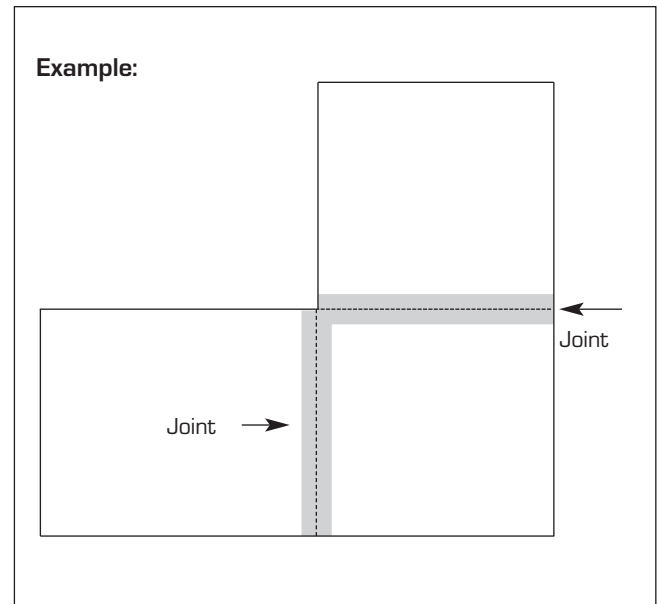

## Movement joints / Dummy joints

### Movement joints

In case of cement screeds designated for stone or ceramic coverings with surface sizes starting from approx. 40 m<sup>2</sup>, screed fields should be constructed separately by using aquatherm<sup>®</sup>-expansion joint profiles. The expansion joint profile is supplied as a complete set consisting of T-profiles and expansion strips made of PE.

The side length of single floor fields should not exceed 8 m. The side ratio may not be larger than 1:2. Movement joints are joints in the screed separating completely up to the insulation layer. Heating pipes may only cross those movement joints as connection ducts. In this case the pipes must be protected with the aquatherm<sup>®</sup> corrugated pipes (approx. 30 cm).

Movement joints must run congruently starting from the insulation layer up to the covering.

After completion of the covering the movement joints have to be closed with an elastic joint seal on the upper side.

Movement joints should be placed in case of heating screed in door sills and for tiles and ceramic coverings between different heated circuits within one heating field.

### Dummy joints

Dummy joints are predetermined breaking points for the abbreviation of screed. The trowel indent is made in the fresh screed mortar.

The arrangement of dummy joints is applied where movement joints are not required but where tensions of the screed plate should be transferred.

Correct arrangement of the movements joints:

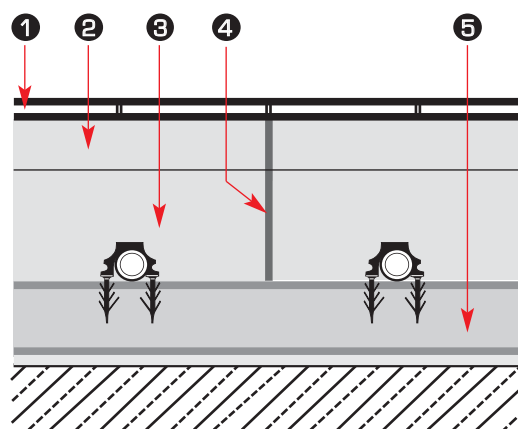

- ① Stone covering
- ② Mortar bed
- ③ Cement screed
- ④ Movement joint
- ⑤ Heat-impact sound insulation

Wrong arrangement of the movements joints:

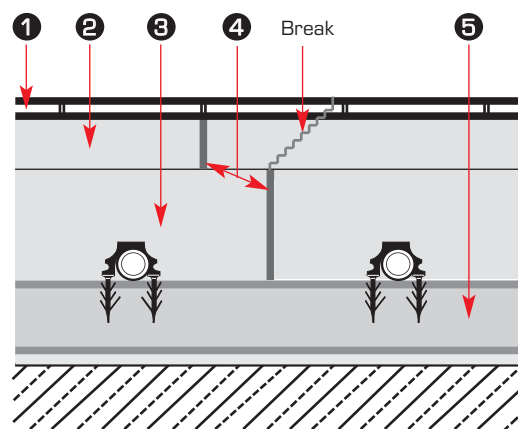

# Floor reinforcement / Procedures floor coverings

## Floor reinforcement

Reinforcement of screeds on insulation layers is generally not necessary.

However for cement floors with stone or ceramic coverings same is useful, as an enlargement of possibly resulting cracks and the displacement height of the cracked edges can be avoided.

The reinforcement has to be made with reinforcing steel meshes with a mesh width of 150 mm x 150 mm or with reinforcing steel meshes with the following parameters:

Mesh width	Diameter	Rigidity
50 mm x 50 mm	2 mm	700 N / mm <sup>2</sup>
75 mm x 75 mm	3 mm	500 N / mm <sup>2</sup>
100 mm x 100 mm	3 mm	500 N / mm <sup>2</sup>

The reinforcement has to be interrupted in the range of movement joints and to be arranged in approx. the middle third of the thickness of the screed.

The reinforcement meshes must never be pushed through the edge insulation.

Floor reinforcements must be free from edges to avoid mechanical damage of the pipes.

Principally reinforcing steel meshes will never prevent cracking of the heating screed. Reinforcing steel meshes have to be protected against corrosion, especially on using anhydrite screed.

As the professional installation of reinforcing steel meshes with thin-layer screeds is rather difficult, it is recommended to add screed synthetic fibres for this type of screed.

## Procedures floor coverings

### Thin mortar bed technique

With the thin mortar bed technique coverings are glued together with a suitable bonding agent on the screed.

Only products indicated by the manufacturer may be used.

### Thick mortar bed technique

With the thick mortar bed technique the stone floors are placed directly in the mortar. The thickness of the mortar depends on the used stone covering.

The minimum thickness is 15 mm.

### Placing with fresh screed

Large-surface stone plates can be beaten directly in the mortar bed. The advantage of this type of placing surely is the fact that different thickness of the covering can be levelled.

The full mortar bed has to be mixed with aquatherm<sup>®</sup>-screed additive.

# Floor coverings / Conditions for placing

## Floor coverings

The following types of covering are suitable for the aquatherm<sup>®</sup>-underfloor heating:

- ceramic tiles and plates
- natural stone (marble, etc.)
- elastic coverings (e.g. PVC-floor)
- textile coverings (carpet floor)
- parquet / laminate

## Thermal resistance

The thermal resistance as per DIN EN 1264 for surface coverings is  $0.15 \text{ m}^2 \text{ K} / \text{W}$ .

The respective installation instructions, standards resp. regulations for the individual types of covering have to be considered.

## Conditions for placing

The following conditions must be fulfilled prior to placing of the selected surface covering:

- a) The screed has been heated acc. to the aquatherm<sup>®</sup>-installation instructions.
- b) The flow temperature has to be kept until the moisture content equilibrium of the table has been reached.
- c) All edge joints and movement joints have been checked on correct arrangement and execution.
- d) Remaining solid matters (e.g. mortar remains) have been removed completely.

## Working material

Only such materials may be used as priming materials, fillers, adhesives / cement and thin bed mortar as indicated by the manufacturer to be "suitable for underfloor heating systems". The manufacturer has to guarantee the heat aging stability.

Thin bed mortar and adhesives must be resistant to a permanent temperature up to  $50^\circ \text{C}$  and also compensate permanently different heat expansions of the screed and the surface covering.

Textile surface coverings must be glued all-over the surface and have to be provided by the manufacturer with the supplement "suitable for underfloor heating systems".

# Heating of screed / Moisture content equilibrium

## Heating of screed

Anhydrite and cement screeds must be heated prior to placing of floor coverings. When switching off the floor heating after the heating phase the screed has to be protected against draft and rapid chilling.

Differing from the method of other hot-water heating systems the cement screed should be heated after 21 days at the earliest and the anhydrite screed according to the indications of the manufacturer, however after 7 days at the earliest.

The first heating starts with a flow temperature of 25° C, which has to be kept for 3 days. Afterwards the maximum flow temperature is adjusted and kept for another 4 days. It is not quite guaranteed that after the described heating procedure the screed has reached the moisture content necessary to be ready for placing.

### REMARK:

The table below contains reference values for being ready for placing, measured with a CM-unit (moisture tester) at approx. 20° C room temperature.

## Moisture content equilibrium

Prior to placing of the floor covering the screed must have reached the moisture content equilibrium acc. to the following table.

The moisture content equilibrium must be checked by the company placing the floor covering. There must be 3 measuring points per 200 m<sup>2</sup> resp. per flat.

### Decisive maximum moisture content of screeds for readiness for placing the floor coverings

Floor covering	Moisture content cement screed	Moisture content anhydrite screed
Stone and ceramic coverings in thin bed	2.0 %	0.5 %
Stone and ceramic coverings in mortar bed on parting layer	2.0 %	0.5 %
Stone and ceramic coverings in thick bed	4.0 %	(not suitable)
Textile coverings permeable to steam	3.0 %	1.0 %
Textile coverings steam-resistant	2.5 %	0.5 %
Elastic floor coverings e.g. PVC, rubber, lino	2.0 %	0.5 %
Parquet / Laminate	2.0 %	0.5 %

## Starting record of aquatherm-hot water underfloor heating acc. to DIN EN 1264, Part 4

Project \_\_\_\_\_  
 Street \_\_\_\_\_  
 PC/ City \_\_\_\_\_  
 Part of the plant \_\_\_\_\_  
 aquatherm system  Roll 35-3  knob plate F ND 35-3  knob plate FND 11  valutherm

### 1. Leak test

The tightness of the circuits is checked by a water pressure test directly before laying the screed. Then the working pressure is adjusted and kept. The test pressure must be the 1.3 fold of the maximum permissible working pressure, but at least 1 bar overpressure.

Max. permissible working pressure \_\_\_\_\_  
 Test pressure \_\_\_\_\_  
 Load duration \_\_\_\_\_

The tightness has been ascertained; no remaining form changes at any component.  
 Advice: Adjustment of the aquatherm®-heating circuit valves after flushing of the system.

### 2. Functional heating for calcium sulphate screed and cement screed

The perfect function of the heated floor construction is checked by the functional heating.

- ➔ With cement screed it can be started 21 days after finishing the screed works at the earliest
- ➔ With calcium-sulphate screed after 7 days at the earliest (acc. to manufacturer's indication)

Type of screed / product  cement screed  calcium-sulphate screed  
 Used fixing agent  screed additive  screed additive "Special"  
 Conclusion of screed works \_\_\_\_\_ Date  
 Start of functional heating \_\_\_\_\_ Date  
(The constant flow temperature of 25°C has to be kept for 3 days.)  
 Adjustment of maximum flow temperature of \_\_\_\_°C \_\_\_\_\_ Date  
(The max. flow temperature (follow manufacturer's instructions) must be kept for 4 days).  
 End of the functional heating \_\_\_\_\_ Date

**Attention: the functional heating does not guarantee, that the screed has the right moisture content for the readiness for placing the floor coverings.**

The functional heating has been interrupted  no  yes from \_\_\_\_\_ until \_\_\_\_\_

The rooms have been aerated without draught and all windows / outside doors have been closed after switching off the floor heating. The heated floor surface was free from construction material and heavy coverings. The plant has been released for further constructions at an outside temperature of \_\_\_\_°C.

- The plant was out of action
- The floor has been heated with a flow temperature of \_\_\_\_°C.

Confirmation (date/stamp/signature)

\_\_\_\_\_  
 Owner/Client

\_\_\_\_\_  
 Constructor/Architect

\_\_\_\_\_  
 Heating engineer







## **Chapter 5**

Heating and cooling system  
for wall and ceiling

## Heating and cooling with the aquatherm-climasystem

### System review

An individual's physical well being directly depends on the basic environmental conditions of the surroundings. Working efficiency varies according to temperature with every cooling degree.

Incorrect controlled room temperature, noise interference or draught are responsible for inefficient room conditions and therefore unsatisfactory performances. In offices, commercial premises, meeting rooms, etc., aquatherm pipe grids have become increasingly more popular for heating and cooling of ceilings and walls.

The ingenious aquatherm climasystem delivers pleasant room conditions without noise and forced air movement.

With this technology cooling or heating is simply controllable.

Automatic designed change-over of heated or chilled water completes this system; allowing for individual room control within a building management system.

Suspended ceiling



Plastered wall/ceiling

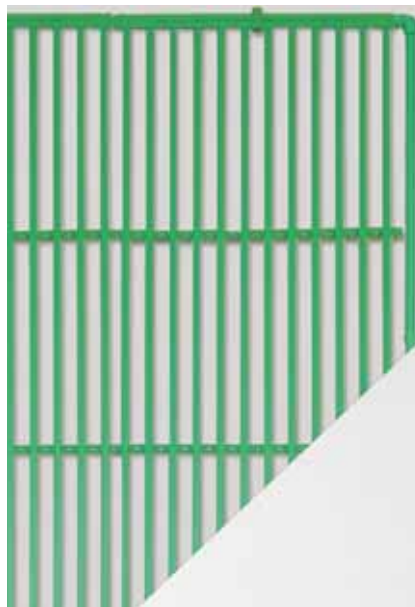

Dry-lined wall



# Heating and cooling with the aquatherm-climasystem

## System review

aquatherm-climasystem – due to its slim construction it fits within the plaster layer or behind the dry-lined wall. Construction thickness including manifolds, mounting rail and connections amounts to only 24.5 mm. The pipe grids have rectangular manifolds, which can be interlinked.

This allows an easy connection e.g. according to the reverse return principle (Tichelmann). The water volume for the required thermal output is distributed via square pipes (12 mm / 25 m pipe per m<sup>2</sup>) within the grids.

The velocity of flow and the pressure drop are minimized.

The aquatherm-climasystem can be installed, in the case of suspended ceilings, dry construction behind gypsum board or wet construction, embedded within the plaster layer.

Even stud framed walls with gypsum board finishes are not a problem.

The low weight of only 2.5 kg / m<sup>2</sup> (incl. water filling) does not effect the design of the ceiling element construction. The ceiling elements should include 30 mm of fibre glass insulation. Depending on their design, the pipe grids are connected by means of thermal welding or by pushfit couplings, and connected to the cooling- and heating water circuits.

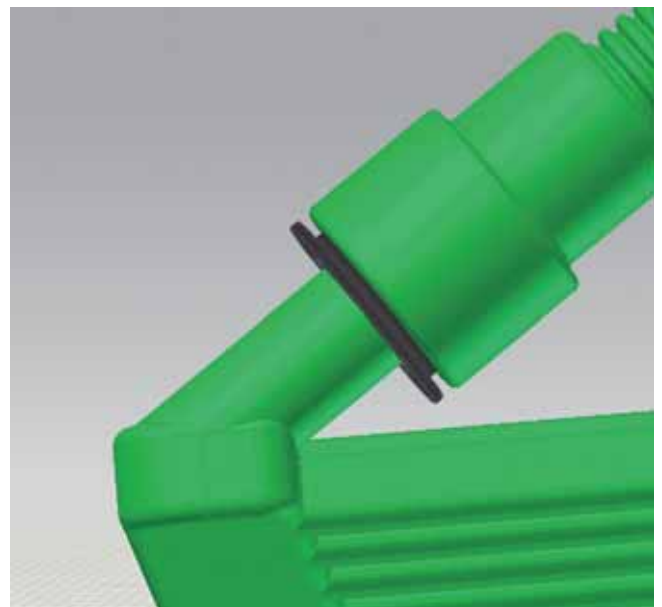
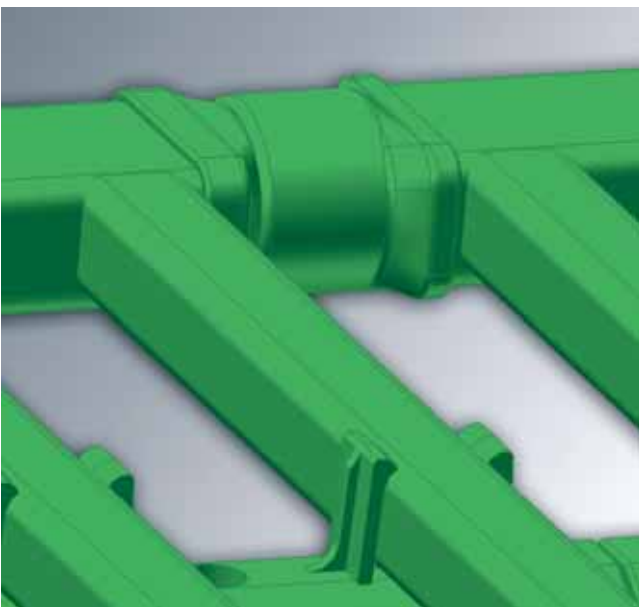

## Heating and cooling with aquatherm-climasystem

### Advantages

- ➔ No draughts
- ➔ Noiseless
- ➔ Dust reduction
- ➔ Simple control technique
- ➔ Thermal properties of the building are enhanced
- ➔ System extendable
- ➔ Quick installation thanks to high degree of prefabrication
- ➔ Even temperature distribution
- ➔ Safe connection techniques by thermal fusion / Pushfit connection for ceiling elements
- ➔ Oxygen barrier
- ➔ Minimal construction thickness
- ➔ Greater architectural design freedom
- ➔ Energy saving
- ➔ Suitable as plaster base for ceiling suspension

The effect of the aquatherm-climasystems is to heat or cool the surface of wall or ceiling it is installed behind by a few degrees below or above the ambient temperature. By radiation exchange with the surfaces, temperatures of the room and furnishings change. The total power is achieved by 2 / 3 radiation and 1 / 3 convection. The heat transfer rate is determined by the difference between ambient temperature and average surface temperature - high difference - high heat transfer.

Within a suspended ceiling system, the extent of the aquatherm-climasystem installation will be governed by the heating and cooling requirements.

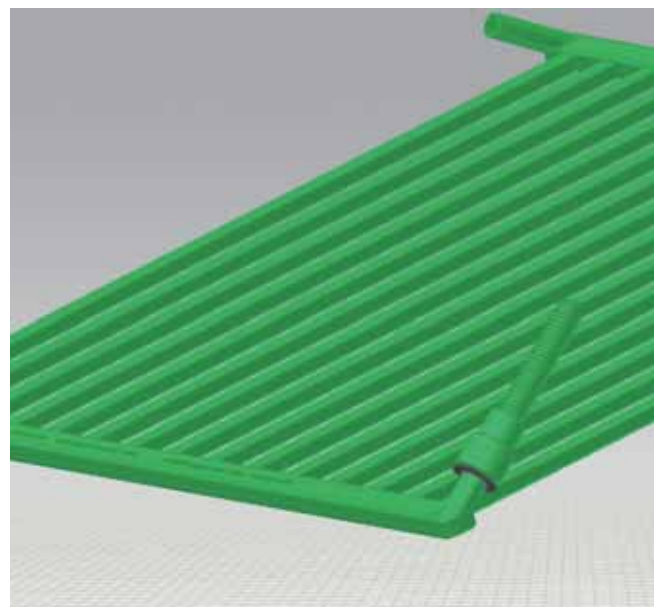

## climasystem: pipes and pipe grids

### Material

aquatherm-pipe grids are exclusively made from fusiolen® PP-R (80).

Its extreme temperature stability is a major property of the product. This physical property is of special interest in the heating and cooling industry.

The exceptionally good welding properties and fusion, result in an homogeneous unit, offering a maximum in security and life span.

fusiolen® PP-R (80) also offers high temperature and pressure operation.

Long-term temperatures of 70° C can easily be maintained. As a rule, the aquatherm climasystem operates at substantially lower temperatures than conventional heating systems. Hence, the actual material stressing is substantially lower. Furthermore fusiolen® offers an excellent robustness against various aggressive chemicals.

In conjunction with the climatherm-pipe system (also made from fusiolen® PP-R (80)) for climate, heating and plant technology, aquatherm offers a complete solution from the heating and cooling source.



## climasystem: pipes and pipe grids

### WALL

#### Heating and cooling

Material:	fusiolen® PP-R (80)
Ø Collector/manifold:	24 / 14 mm
Ø Grid pipe:	12 / 12 mm
Pipe spacing A:	40 mm
Width B:	24 cm, 48 cm, 60 cm
Length L:	50 cm 60 cm 80 cm 100 cm - 500 cm
Volume:	approx. 1.2 ltr / m <sup>2</sup>
Weight incl. waters:	approx. 2.5 kg / m <sup>2</sup>
Exchange surface:	approx. 1.0 m <sup>2</sup> / m <sup>2</sup>
Connection:	Ø 16 mm welding connection
Operational area:	Wall heating/cooling Wall heating in the plaster Wall cooling in the plaster
Working pressure:	4 bar
Max. heating water temperature:	70° C

### CEILING

#### Heating and cooling

Material:	fusiolen® PP-R (80)
Ø Collector/manifold:	24 / 14 mm
Ø Grid pipe:	12 / 12 mm
Pipe spacing A:	40 mm
Width B:	57.5 cm [compatible with standard ceiling panel 60.0 x 60.0 cm] 61.5 cm [compatible with standard ceiling panel 62.5 x 62.5 cm]
Length L:	57.5 cm 61.5 cm
Volume:	approx. 1.4 ltr / m <sup>2</sup>
Weight incl. waters:	approx. 2.5 kg / m <sup>2</sup>
Exchange surface:	approx. 1.0 m <sup>2</sup> / m <sup>2</sup>
Connection:	push-fit connection
Field of application:	Ceiling heating Ceiling cooling on metal panel or gypsum tiles
Working pressure:	4 bar
Max. heating water temperature:	70° C

Special dimensions on request



# Connection method

## Part 1: fusion

### Fusion

The aquatherm-climasystem is connected by “fusion”.

Simply by heating up the joining elements the plastic melts, allowing the connecting of parts with a single material and forming a permanent connection. The grids can be connected in parallel as well as in series.

Due to the wide range of fusiotherm® fittings single connection as well as complete commercial sized installations, including manifolds, can be constructed.

Transition connections for the approved aquatherm®-SHT sliding sleeve technology completes the system.

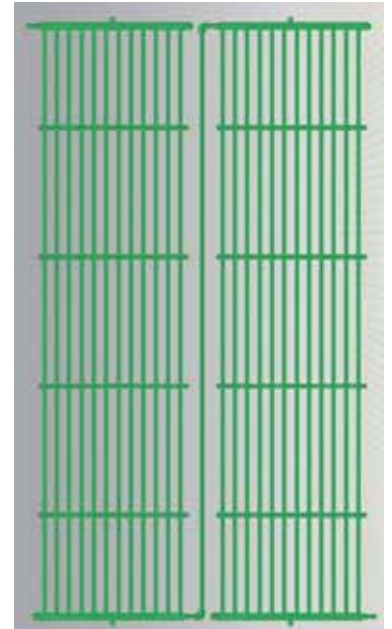
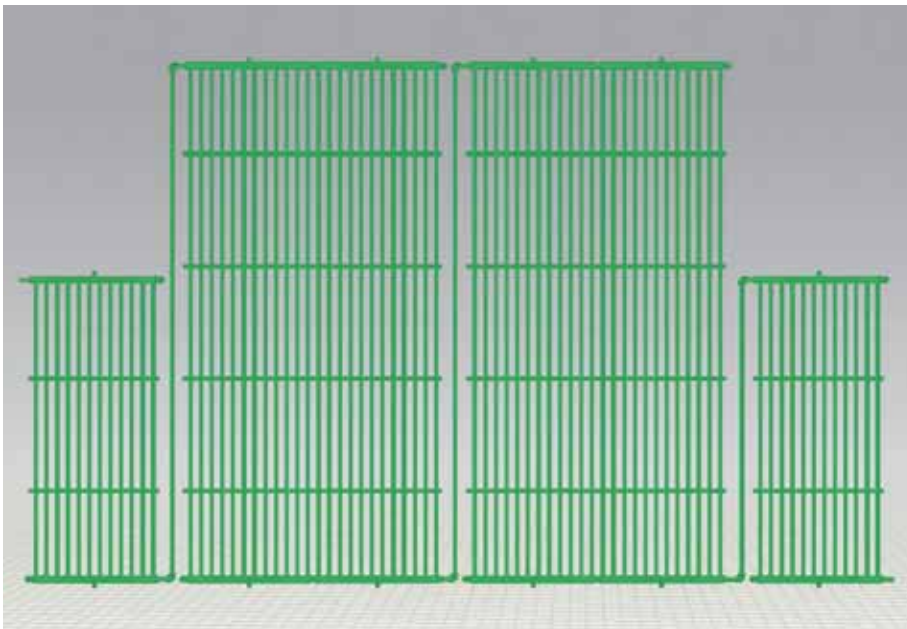

## Connection method Part 1: fusion

Fusion of the aquatherm-climasystem

### in parallel:

(Maximum 4 grids at the same level, of maximum total surface area of 15 m<sup>2</sup> per circuit, may be connected.)



1. Mounted welding device and tools (16 mm)  
Control of temperature

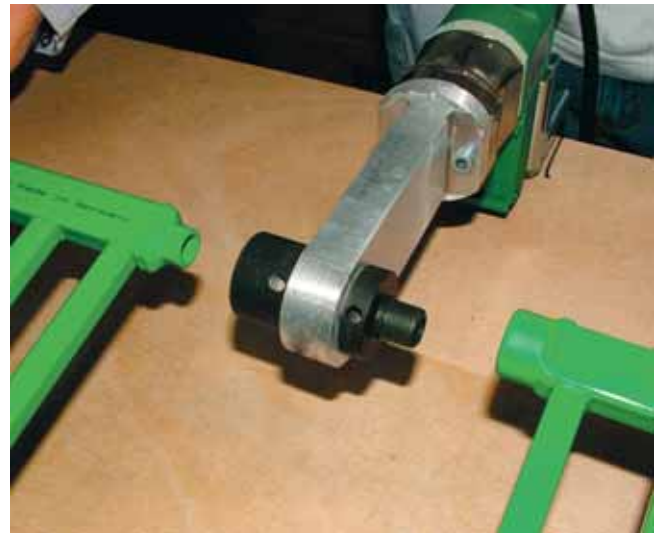

2. aquatherm-climasystem is equipped with male / female connections for parallel fusion



3. Push internal connection of the first grid into the (socket) heating tool and at the same time the external connection of the second grid onto the (spigot) heating tool.



4. After the required warm-up time of 5 sec., remove the elements from the tools and immediately push together (welding depth 13 mm).

## Connection method Part 1: fusion

Fusion of the aquatherm-  
climasystem

**with series connections:**

Wall heating and cooling grids with series connection are  
fused with diffusion-tight connection pipes and fittings.  
(The maximum surface per circuit is 15 m<sup>2</sup>)



Fusion...



... of pipe pieces.

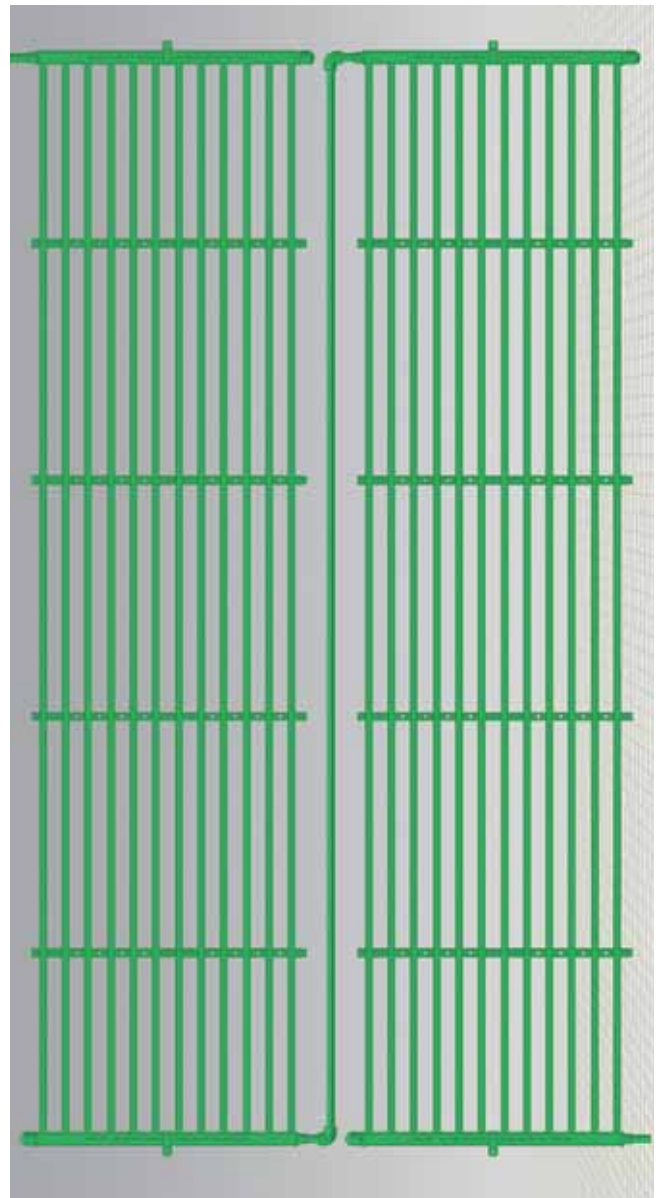

## Heating and cooling grids

Art.-No.	Dimension surface (m <sup>2</sup> )	PU	Price / Piece	Product-group
81105	24 x 50 cm 0.12 m <sup>2</sup>	10 pc	1 pc	20
81305	48 x 50 cm 0.24 m <sup>2</sup>	10 pc	1 pc	20
81405	60 x 50 cm 0.30 m <sup>2</sup>	10 pc	1 pc	20
81106	24 x 60 cm 0.14 m <sup>2</sup>	10 pc	1 pc	20
81306	48 x 60 cm 0.29 m <sup>2</sup>	10 pc	1 pc	20
81406	60 x 60 cm 0.36 m <sup>2</sup>	10 pc	1 pc	20
81108	24 x 80 cm 0.19 m <sup>2</sup>	10 pc	1 pc	20
81308	48 x 80 cm 0.38 m <sup>2</sup>	10 pc	1 pc	20
81408	60 x 80 cm 0.48 m <sup>2</sup>	10 pc	1 pc	20
81110	24 x 100 cm 0.24 m <sup>2</sup>	10 pc	1 pc	20
81310	48 x 100 cm 0.48 m <sup>2</sup>	10 pc	1 pc	20
81410	60 x 100 cm 0.60 m <sup>2</sup>	10 pc	1 pc	20
81115	24 x 150 cm 0.36 m <sup>2</sup>	10 pc	1 pc	20
81315	48 x 150 cm 0.72 m <sup>2</sup>	10 pc	1 pc	20
81415	60 x 150 cm 0.90 m <sup>2</sup>	10 pc	1 pc	20
81120	24 x 200 cm 0.48 m <sup>2</sup>	5 pc	1 pc	20
81320	48 x 200 cm 0.96 m <sup>2</sup>	5 pc	1 pc	20
81420	60 x 200 cm 1.20 m <sup>2</sup>	5 pc	1 pc	20
81125	24 x 250 cm 0.60 m <sup>2</sup>	5 pc	1 pc	20
81325	48 x 250 cm 1.20 m <sup>2</sup>	5 pc	1 pc	20
81425	60 x 250 cm 1.50 m <sup>2</sup>	5 pc	1 pc	20
81130	24 x 300 cm 0.72 m <sup>2</sup>	2 pc	1 pc	20
81330	48 x 300 cm 1.44 m <sup>2</sup>	2 pc	1 pc	20
81430	60 x 300 cm 1.80 m <sup>2</sup>	2 pc	1 pc	20



with oxygen barrier, with single entry fusion connection (incl. respective number of wall clamps, fixing rails and fixing clamps with plug)

Art.-No.	Dimension surface (m <sup>2</sup> )	PU	Price / Piece	Product-group
81135	24 x 350 cm 0.84 m <sup>2</sup>	2 pc	1 pc	20
81335	48 x 350 cm 1.68 m <sup>2</sup>	2 pc	1 pc	20
81435	60 x 350 cm 2.10 m <sup>2</sup>	2 pc	1 pc	20
81140	24 x 400 cm 0.96 m <sup>2</sup>	2 pc	1 pc	20
81340	48 x 400 cm 1.92 m <sup>2</sup>	2 pc	1 pc	20
81440	60 x 400 cm 2.40 m <sup>2</sup>	2 pc	1 pc	20
81145	24 x 450 cm 1.08 m <sup>2</sup>	2 pc	1 pc	20
81345	48 x 450 cm 2.16 m <sup>2</sup>	2 pc	1 pc	20
81445	60 x 450 cm 2.70 m <sup>2</sup>	2 pc	1 pc	20
81150	24 x 500 cm 1.20 m <sup>2</sup>	2 pc	1 pc	20
81350	48 x 500 cm 2.40 m <sup>2</sup>	2 pc	1 pc	20
81450	60 x 500 cm 3.00 m <sup>2</sup>	2 pc	1 pc	20

## Connection method

### Part 2: push-fit connection

The aquatherm-climasystem in suspended ceilings comes with pushfit-connectors for a fast and secure connection.

climasystem has serial 16 mm connections, on which the pushfit-connection is inserted to the stop.

The holding element / ring inside, is equipped with stainless steel teeth, keeping the connection firmly in the joint. The **two** integrated o-rings guarantee a completely sealed and secure connection.

### Various connections are available for joining climasystem with the pipe systems

Corrugated connecting pipe (57 cm length) with various connections:

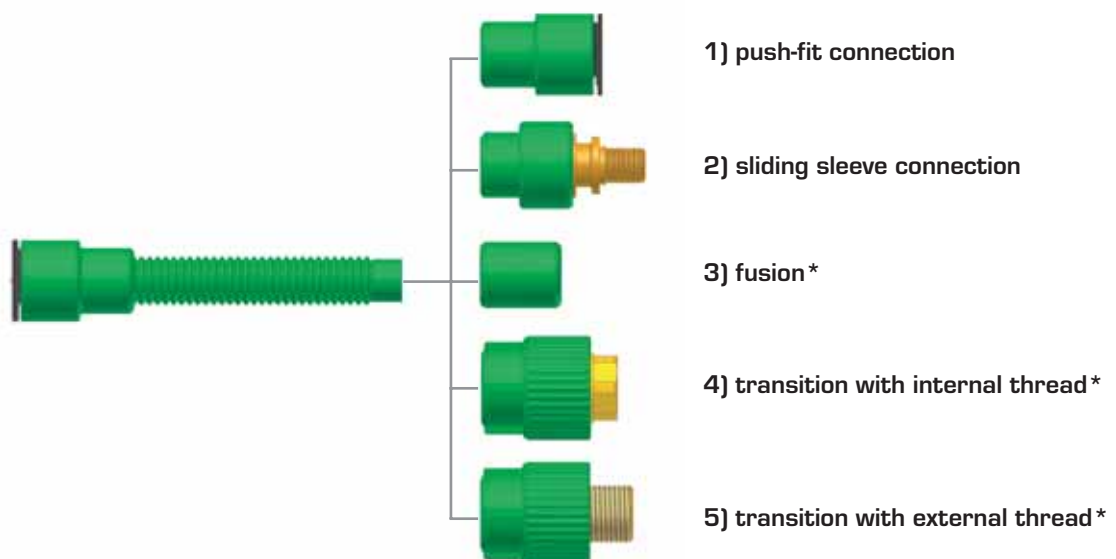

\* (fittings of the fusiotherm-system)

## Connection method Part 2: push-fit connection

To allow maintenance within the ceiling void, the pushfit connections are demountable. It is important to ensure, that the system is unpressurized and drained down before attempting to demount the connection.

Then simply press the holding ring (**black ring**) against the connector and pull apart.

The connection is then reusable.

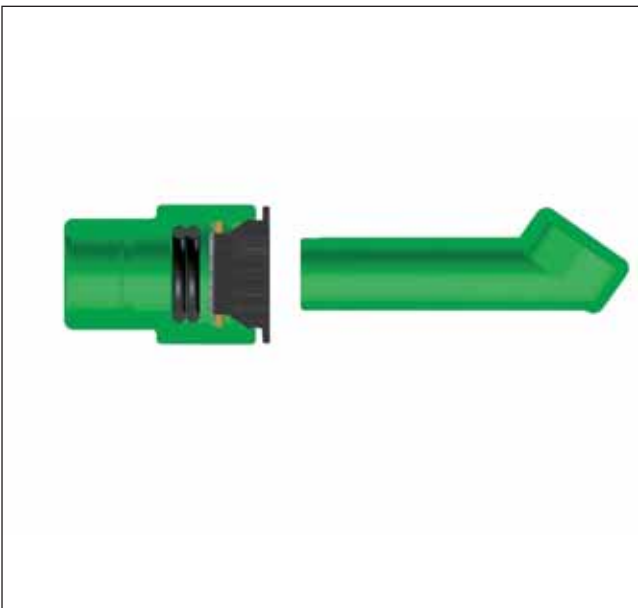

# System technique aquatherm-climasystem

## System review

The concept of the aquatherm-climasystem is for the comfort of an occupied area: thermally well-balanced zones are created.

The principle of the aquatherm-climasystem technology is gentle radiant heat from large surfaces delivering comfort and warmth to the occupants of a room. Since the heating surfaces are relatively large the surface temperature can be kept low reducing air movement. Radiant heat is felt directly, this is one advantage over small hot radiators that create high convectional currents warming the air before the occupants.

Since the system has a low flow temperature (25 - 35° C) it is ideally suited to being used with eco-friendly fully condensing boilers or alternative energy sources like combined heat and power, solar, geothermal and heat recovery systems.

Besides the thermal advantages there is the added benefit of reduced air movement. The result is reduced dust movement with stabilized humidity.

In conclusion wall heating, resp. ceiling heating, saves 25 - 30 % of energy costs and contributes to a healthy environment. Of course the aquatherm-climasystem for wall and ceiling can be combined with each other.

## Requirements for installation

aquatherm-climasystem can be installed on standard brick or block walls / ceilings within studwork or on pre-cast concrete walls / ceilings. The walls (subsurface) must be dry and level for taking the plaster or the dry construction elements.

Normally plastering is possible on all plaster subsurfaces. Due to liabilities it is to distinguish between plaster-friendly and difficult subsurfaces. According to the conditions the selection of plaster, of processing and pre-treatment have to be adapted.

The subsurface must be checked acc. to VOB Part C, DIN 18350 resp. acc. to VOB Part B, DIN 1961 by the contractor (plasterer).

(For pre-treatment e.g. primer is applied.)

The tolerance of the heights and inclination of the carrying subsurface must correspond to the German DIN 18202.

Adequate insulation of the outer walls behind the aquatherm climasystem is essential.

## Comfort

Moderate temperatures (20 - 35° C) with large heating surfaces generates steady radiation for the user.

Direct heat radiation on the human body delivers a comfortable warm feeling. The room air temperature can be reduced in opposite to conventional heating technologies (radiators / convectors) and still provide thermal comfort for the occupant.

Principle of heating and cooling:  
wall/ceiling

The aquatherm-climasystem  
for the **wall**

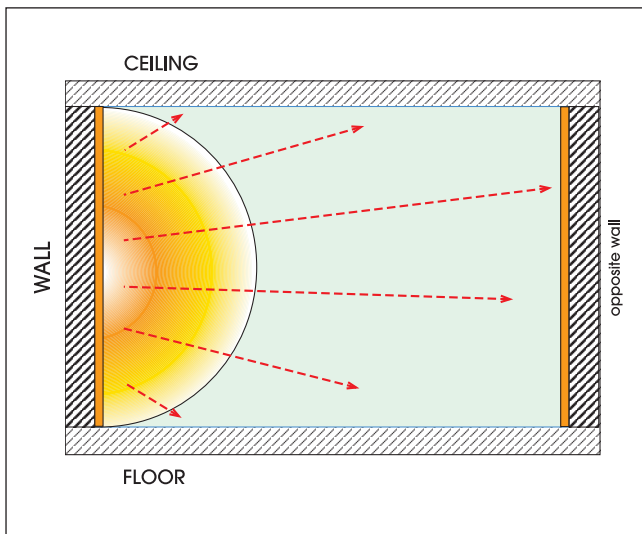

Heating

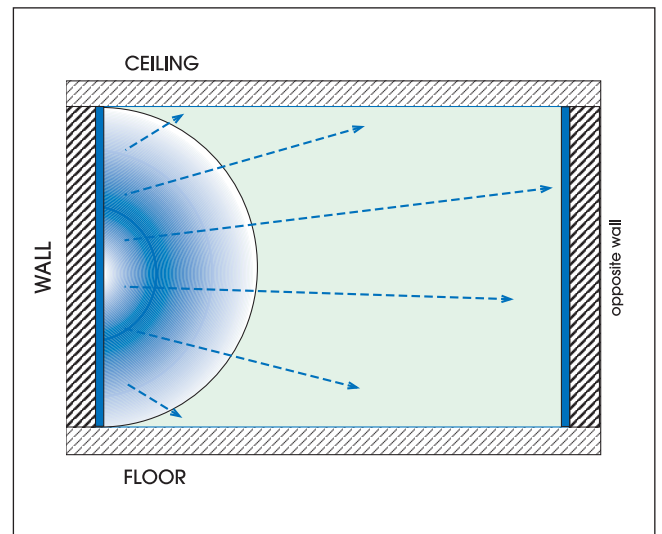

Cooling

The aquatherm-climasystem  
for the **ceiling**

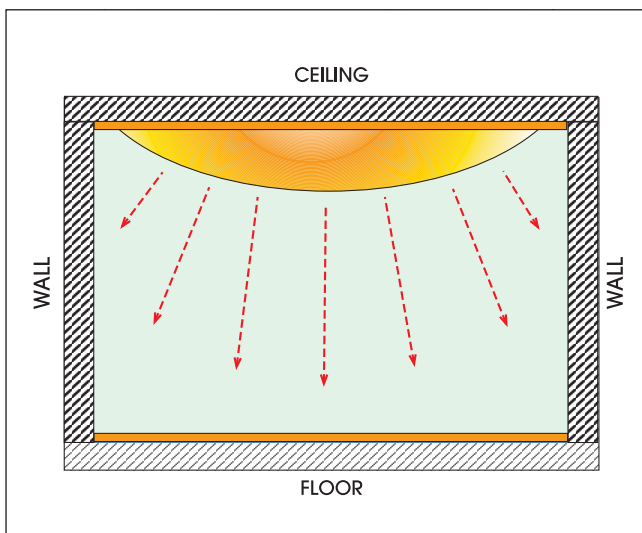

Heating

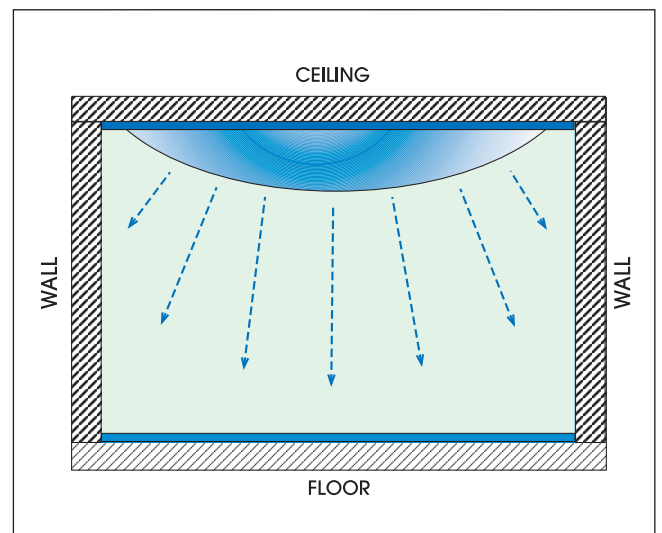

Cooling



# System technology aquatherm-climasystem

## Visual performance **heating**

The photos of the high-resolution thermal camera make its performance clear: The aquatherm-climasystem for wall heating delivers even heat distribution into the space, provides for a comforting warm feeling and creates a very acceptable room climate.

### Example: Metal ceiling panel

Legend:

Room temperature: 20° C

Linear heating temperature: 32° C

Radiation surface temperature: see screen sequence

Original metal ceiling panel



Start of heating

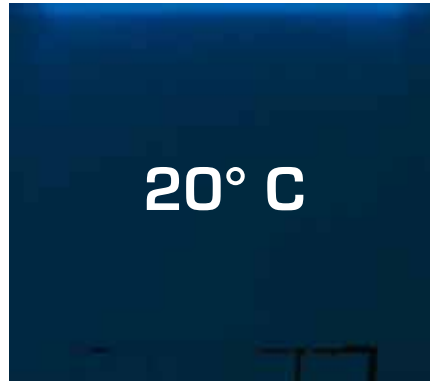

after 1 minute



after 1.5 minutes

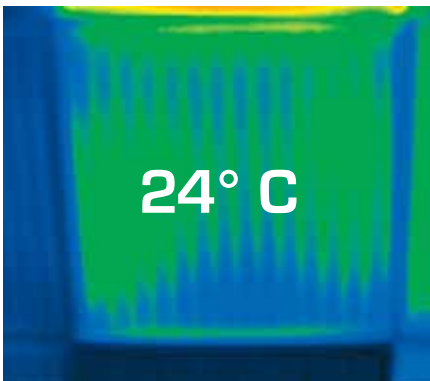

after 2 minutes

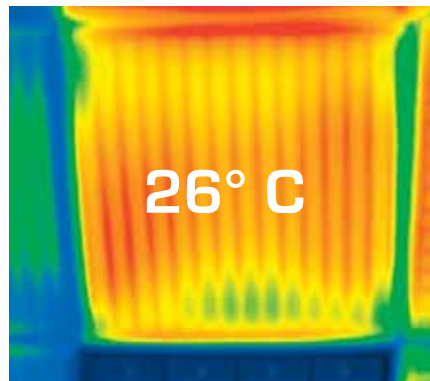

after 2.5 minutes

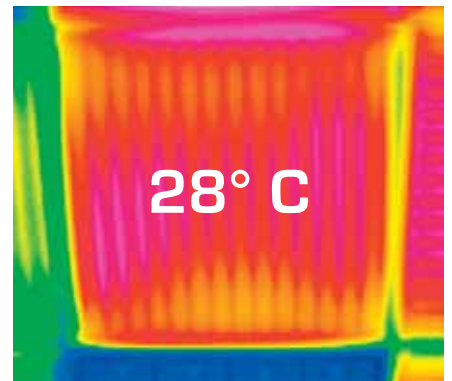

after 3 minutes

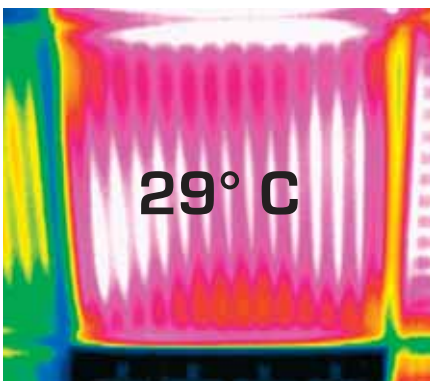

after 3.5 minutes



after 4 minutes



# System technology aquatherm-climasystem

## Visual performance **cooling**

The photos of the high-resolution thermal camera show: The aquatherm-climasystem for cooling ceilings delivers equal coolness into the space and does not only provide for a comfortable but also healthy room climate.

### Example: Metal ceiling panel

Legend:

Room temperature: 24° C

Linear cooling temperature: 17° C

Radiation surface temperature: see screen sequence

Original metal ceiling panel



Start of cooling

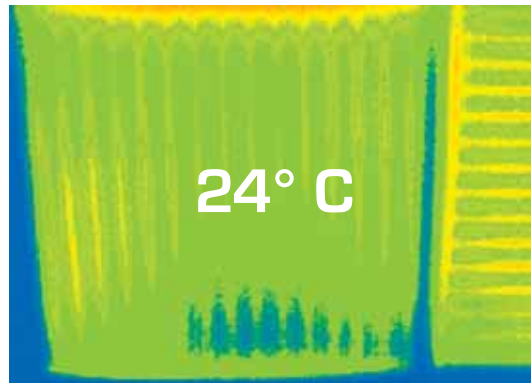

after 1 minute

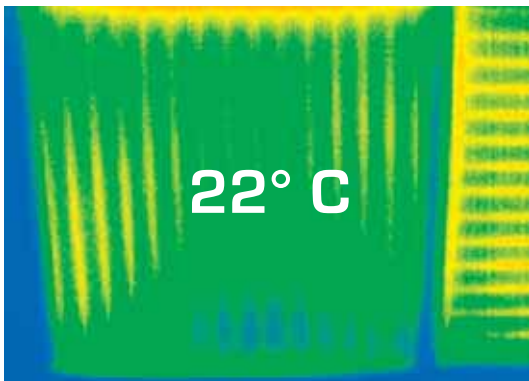

after 2 minutes

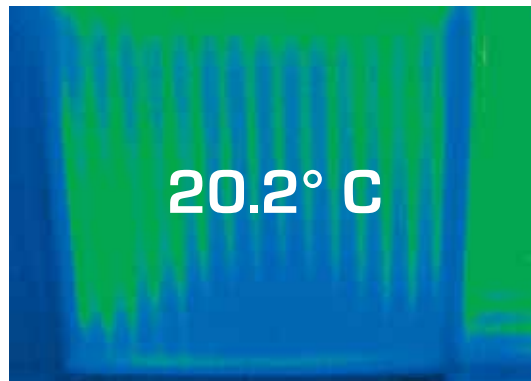

after 4 minutes

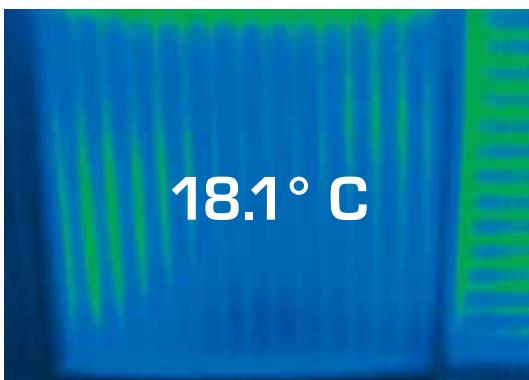

after 6 minutes



# System technology aquatherm-climasystem

## Visual performance **heating**

The photos of the high-resolution thermal camera make its performance clear: The aquatherm-climasystem for wall heating delivers even heat distribution into the space, provides for a comforting warm feeling and creates a very acceptable room climate.

### Example: Wall heating (plastered)

Legend:

Room temperature: 20° C

Linear heating temperature: 32° C

Radiation surface temperature: see screen sequence

Original wall heating (plastered)



Start of heating



after 1 minute



after 1.5 minutes

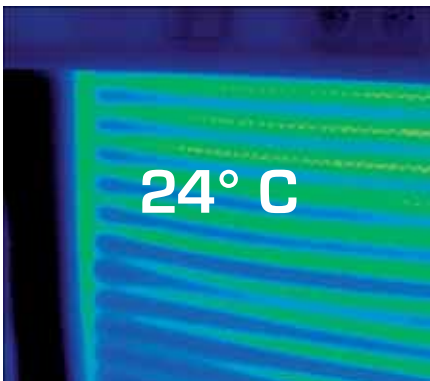

after 2 minutes

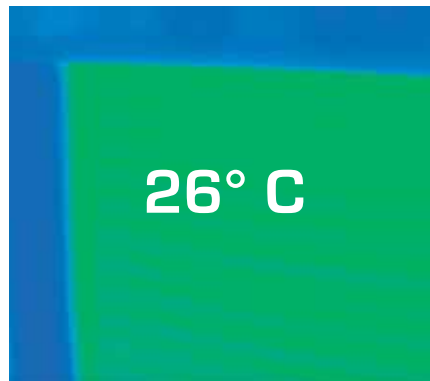

after 2.5 minutes

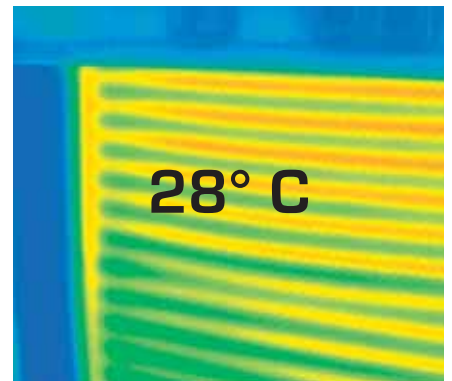

after 3 minutes



after 3.5 minutes

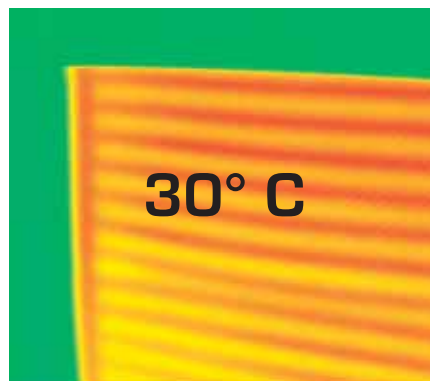

after 4 minutes

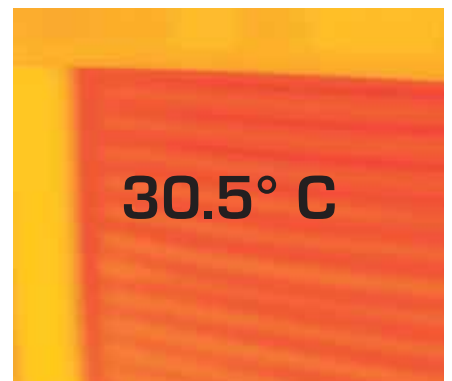

## System technology aquatherm-climasystem

### Visual performance **cooling**

The photos of the high-resolution thermal camera show: The aquatherm-climasystem for cooling ceilings delivers equal coolness into the space and does not only provide for a comfortable but also healthy room climate.

### Example: Wall cooling (plastered)

Legend:

Room temperature: 24° C

Linear cooling temperature: 17° C

Radiation surface temperature: see screen sequence

Original Wall cooling (plastered)



Start of cooling

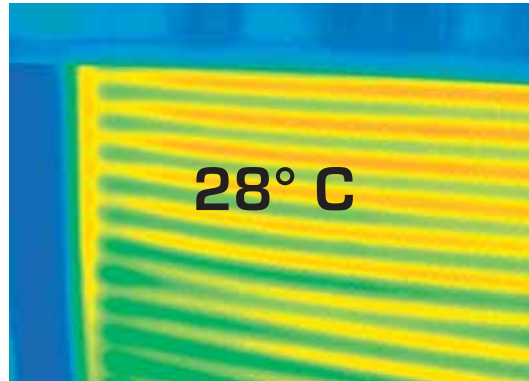

after 1 minute

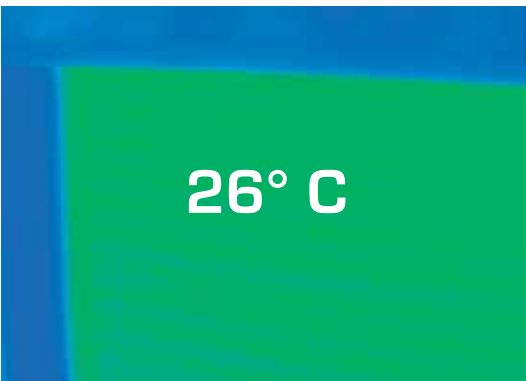

after 2 minutes

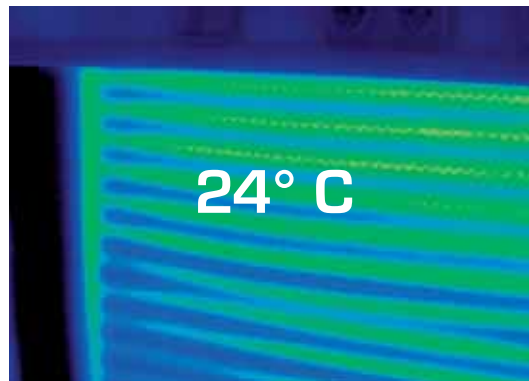

after 4 minutes

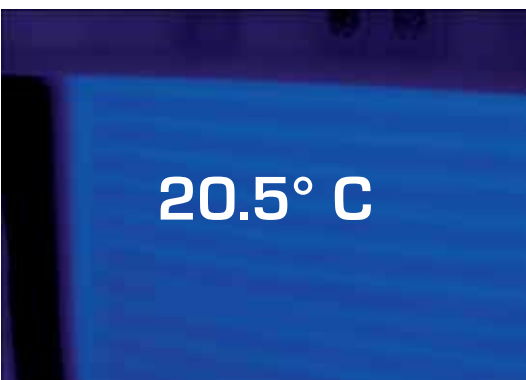

after 6 minutes



# System technology aquatherm-climasystem

## Surface temperatures

The surface temperatures are dependent on the heat efficiency of the wall heating. This also depends on the heat loss of the room / building and on the surface, which is available for the installation of the wall heating.

In addition, the pipe spacing, the surface finishes and the design of the wall heating provide variable differences to the surface temperature.

That means, the temperature above the heating pipes is higher than in the intervals. Even surface temperatures are obtained by the close pipe spacing (40 mm / 25 m pipe per m<sup>2</sup>) of the aquatherm-climasystem.

The average surface temperature of wall heating should be regulated for physiological reasons. In rooms with low dwelling time (e.g. baths, swimming pools, therapeutic areas) the surface temperature is limited to 35° C and in rooms with long dwelling time (e.g. living rooms, day rooms, offices) is limited to 30° C.

## Surface considerations

In the planning stage of wall heating design the future use should be taken into consideration. When arranging the grids personal and spatial needs can be considered. One must take into account, where the large pieces of furniture are to be placed, while smaller furniture (e.g. desk, seat set and pictures) can be disregarded.

Thus the outside wall often remains as a possible choice.

## Conduits and cables

Conduits and cables which are placed on the weight-bearing subsurface, must be well fixed. They can be surface mounted or concealed behind the aquatherm-climasystem.

## Expansion joint

To accommodate for thermal joints length expansion of the wall construction, suitable expansion must be allowed for.

This can be achieved by a flexible joint.

## Plaster and thermal distribution layer

All customary lime-cement plasters and gypsum plasters have proved to be effective.

Due to its very good space-climatic qualities, gypsum and lime-gypsum plasters for wall heating are specially well suited. But never apply them in humid rooms, as the maximum operating temperature of gypsum plaster should not exceed 50° C.

Lime-cement plasters are suitable for higher operating temperatures to approximately 60° C. These plasters are well suitable for baths and wet rooms with high air humidity.

Today clay plasters are used increasingly, because it is an optimal building material for the biological building considerations. In addition, clay plasters, due to their high thermal conductivity, are very suitable for wall heating. The maximum operating temperature is also 60° C, as with the lime-cement plasters.

Plaster reinforcement must be used in general, to prevent possible surface faults.

## Surface finishes

They can be made – according to customer's wish – from ceramic tiles, plasterboards or gypsum plaster.

But the thermal resistance value R (m<sup>2</sup>K / W) should keep as low as possible and a value from R = 0.15 m<sup>2</sup>K / W should not be exceeded.

In this case additional heaters (e.g. in front of the window) may be inevitably.

Surface finishes with high thermal resistance require clearly higher operating temperatures and cause increased heat loss outward through the outside walls.

## Designs Wall and ceiling heating system

Wall- and ceiling heating are divided into different systems, according to their design:

- SYSTEM A**    **wet construction**
- ➔ aquatherm-climasystem is directly installed onto the wall, respectively below the ceiling



- SYSTEM B**    **dry construction**
- ➔ Installation of the aquatherm-climasystem in dry-lined wall
  - ➔ Installation of ceiling heating grids



# Heat control methods

## aquatherm®-Control options

aquatherm, as a supplier of a complete system, offers all necessary components for the optimum control of a wall and ceiling heating. This covers new or old buildings, to the connection of existing heating systems as well as for small surfaces or large objects.

The individual room control for wall and ceiling heating is compellingly prescribed acc. to EnEV, provided that the object is completely heated by it.

If the basic load is covered, the individual room control can be done without.

The following control options are available:

- ➔ control by return temperature limiter for small additional heating surfaces one circuit (design in cabinet for concealed installation)
- ➔ control for larger heating surfaces connection via heating circuit manifold individual room control by means of actuator and room thermostat
- ➔ control for larger heating surfaces connection via heating circuit manifold Division of heating groups, e.g. by means of Tichelmann (reverse return) distribution technique

## aquatherm®-Control technique

The control technique for the aquatherm-climasystem is identical to our aquatherm®-underfloor heating.

Wired controls with 230 volt and 24 volt, or wireless radio control may be used. The technical description of the control components is to infer in the technical brochure "aquatherm®-heating system", chapter "Automatic Control" (order-no. E 90001).

Never mount aquatherm®-room thermostats behind curtains, in draught, or direct to solar radiation.

Also they must not be placed directly on the heated surfaces.

## Heating control methods

### Parallel connection

Maximum 4 grids at the same level, of maximum total surface area 15 m<sup>2</sup> may be connected in parallel

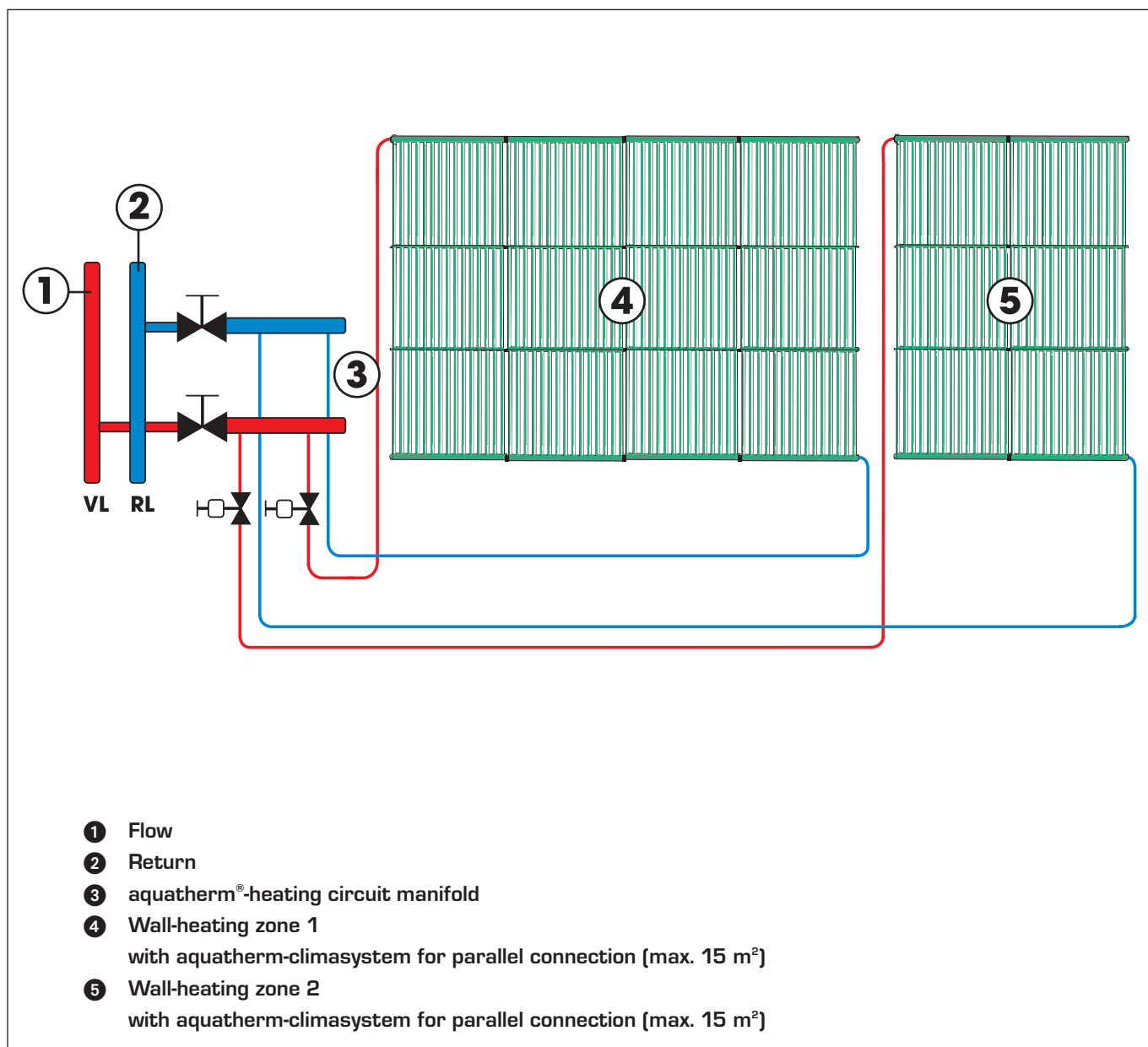



# Heating control methods

## Serial connection

(max. 15 m<sup>2</sup> per circuit)

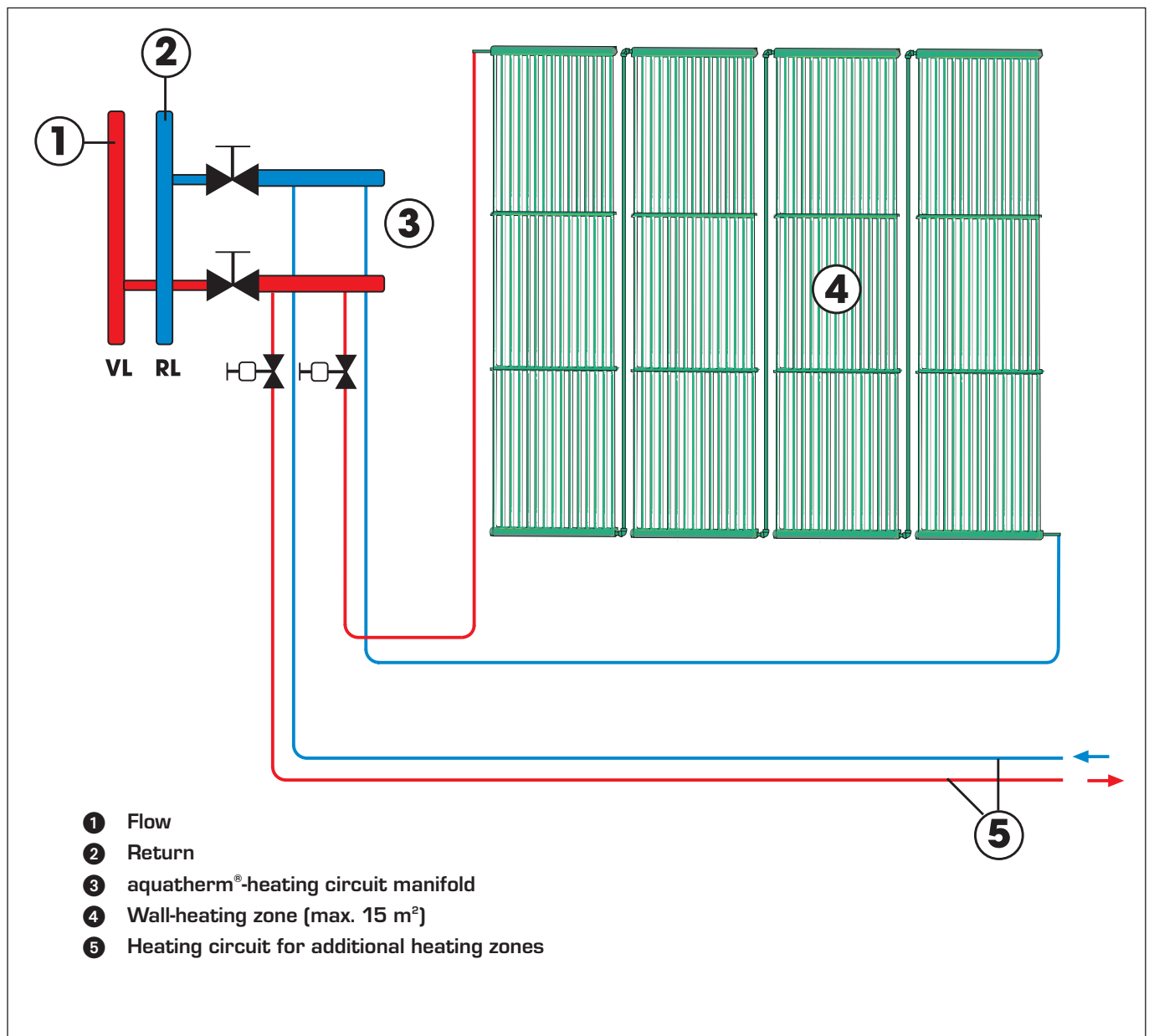

## Heating control methods

Combination of parallel and serial connected surfaces

Combination of parallel and serial connected surfaces (max. 15 m<sup>2</sup> per circuit)

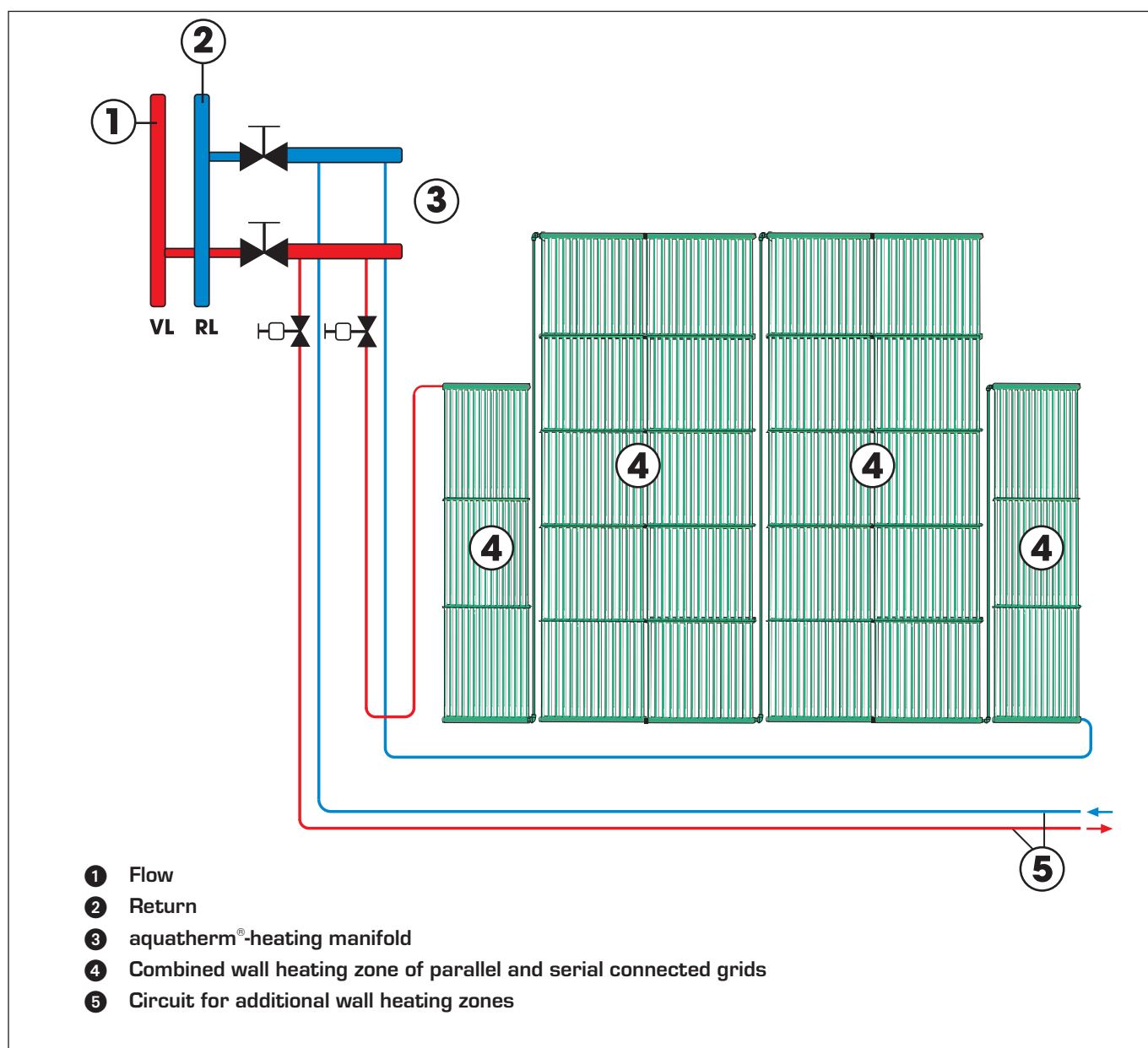

# Heating control methods

Connection of smaller heating surfaces

Connection of smaller heating surfaces  
(max. 8 m<sup>2</sup>) via return temperature limiter

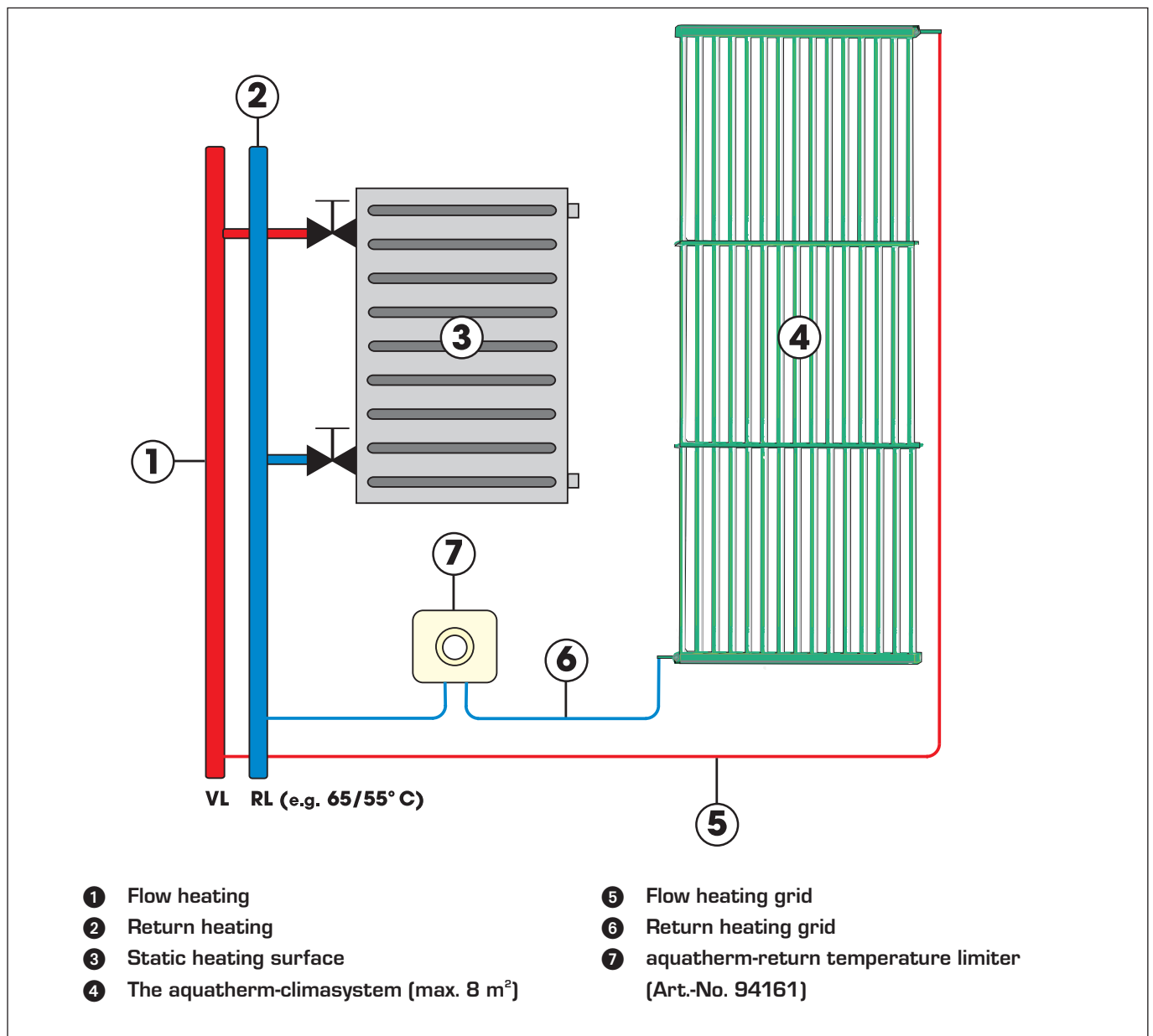

## Heating and cooling: control methods

### Heating:

The aquatherm-heating systems for ceiling, wall and floor are always utilized in winter.

They are installed in private homes, apartments, business buildings, hotels, hospitals, offices, schools, etc. But unfortunately, during the summer months these heating systems are unused.

With the control statement "heating and cooling" the needs "heating and cooling" blend into a single arrangement. Based on climate control with change-over "heating / cooling" a complete control system including all requirements is available.

The control system described below, contains the energy saving features as well as the optimised cooling functions.

### Cooling:

Special care is required to the dew point concerning the space cooling.

The principle pattern takes into consideration the dew point, so that there is no condensation produced.

### Principle pattern of a double-pipe arrangement (Suppliers: e.g. Sauter-Cumulus, Freiburg; Company Siemens, etc.)

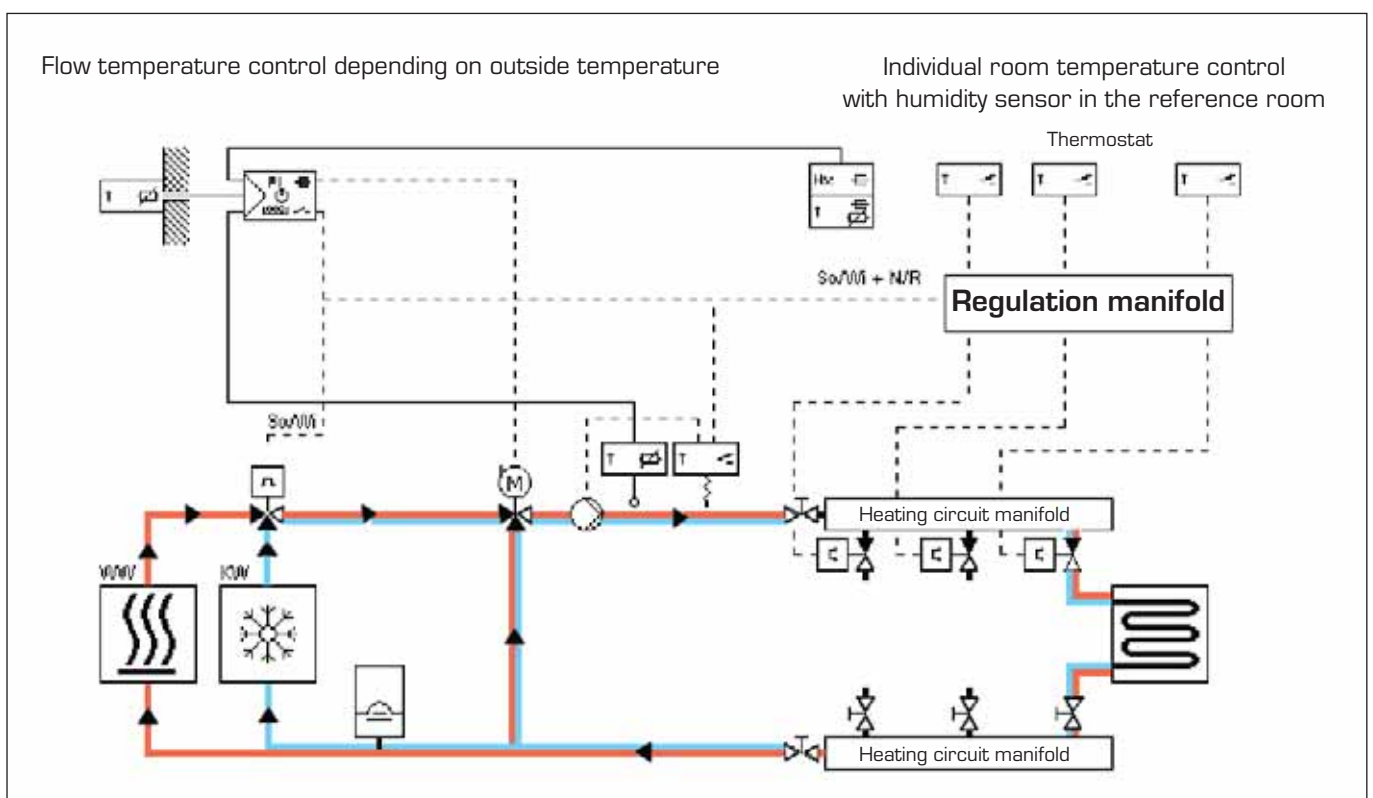

# Planning and design “Heating and cooling”

## Calculation

Generally a heating load calculation acc. to DIN EN 12831 or a cooling load calculation acc. to VDI 2078 has to be performed before designing the aquatherm-climasystem.

$$Q_{\text{Ausl}} = \frac{Q_{\text{H}}}{A_{\text{f}}}$$

$Q_{\text{Ausl}}$  = Dimensioning of heat flux density  
 $Q_{\text{H}}$  = Thermal output acc. to DIN EN 12831 less the loss of transmission heat by the components covered by wall heating  
 $A_{\text{f}}$  = Wall surface, covered with wall heating

## Graphs

The following output graphs for the aquatherm wall and ceiling heating in wet and dry construction method have to be taken into consideration.

These graphs are valid for:

1.) Wet-construction system with wall plaster with thermal conductivity  
 $\Rightarrow \lambda = 0.35 \text{ W / mK}$  (e.g. gypsum plaster)

as well as plaster coverings from upper edge heating pipe  
 = 10 mm

2.) Dry-construction system (performance diagram for the dry construction system is valid for concealing with plaster board)  
 $\lambda = 0.40 \text{ W / mK}$

## Standards and guidelines

The following standards and guidelines must be considered on planning and design of the aquatherm-climasystem:

VDI 2078 cooling load calculation / EnEV Energy saving law  
 DIN EN 1264 Surface heating systems / DIN 1186 Construction gypsums  
 DIN 4102 Fire protection in building construction / DIN 4108 Heat Insulation in building construction / DIN 4109 Sound Insulation in building construction / DIN EN 12831 Calculation of the standard heating load / DIN EN 1264 Hot water under-floor heating / DIN 4726 Conduits of plastic / DIN 18164 Foam plastics / DIN 18165 Fibre insulating materials / DIN 18180 Gypsum plaster boards / DIN 18181 Gypsum plaster boards in building construction / DIN 18182 Accessories for the processing of plaster boards / DIN 18195 Building sealing / DIN 18202 Dimension tolerances in building construction / DIN 18350 Plastering works and stucco works / DIN 18557 Mortar / DIN 18550 Plasters

(Individual processing guidelines of the respective manufacturer)

## Assembly and installation

### Assembly

For the installation of the aquatherm-climasystem follow the manufacturer's recommendations – for plaster works follow the regulations of the plaster manufacturer. Suspended tile-ceilings and prefabricated construction elements have to be installed according to dry construction guidelines resp. manufacturer's advices.

Raw ceilings and walls must have a firm base for the installation of the heating grids. The aquatherm-climatherm comes in variable lengths offered, so that cutting at the building site ordinarily is not necessary. The grids must be connected by means of heating element fusion.

At first the aquatherm-climasystem is fixed with the attached wall brackets (2 pieces per grid) at the raw wall or ceiling. Further fixing occurs through the pre-mounted fixing rail.

A sufficient number of fixings is to be intended!

The fixing element with plug (see picture in the middle below) in conjunction the with fixing rail and the grids can be used as plaster base.

Additional plaster fixings can be left out. Four pieces of fixing clamp with plug are to be installed per m<sup>2</sup> covered surface.



# Assembly and installation

## Starting

### Flushing, filling and venting

The aquatherm-climasystem has to be tested by a pressure test before plaster covering works. Therefore each single pipe – e.g. via filling and drain valves – has to be flushed and refilled until the water comes out free of air.

Wall heating always have to be filled from the bottom to the top. The hydraulic compensation of the system must correspond to the calculation.

### Hydraulic pressure test

According to DIN EN 1264-4 the aquatherm-climasystem has to be pressure tested for density analogously to the tests of underfloor heating systems.

The test pressure must be the double of the operating pressure, but at least 6 bars. This pressure must be kept during the plaster works at the wall or ceiling or during the covering works.

**The density and the test pressure have to be recorded in a test record.**

If there is danger of freezing, suitable measures, like use of anti-freezer or heating of the building have to be met. The anti-freezer must to be removed by draining and flushing with at least triple water change, if no further anti-freezer is necessary for the normal operation of the system.

### Functional heating

The heating of the aquatherm-climasystem depends on the recommendations of the plaster manufacturer and the type of plaster.

Basically the manufacturer's instructions must be strictly adhered to.

The heating test performance has to be documented.

# Wall grid installation ...

... in wet construction method

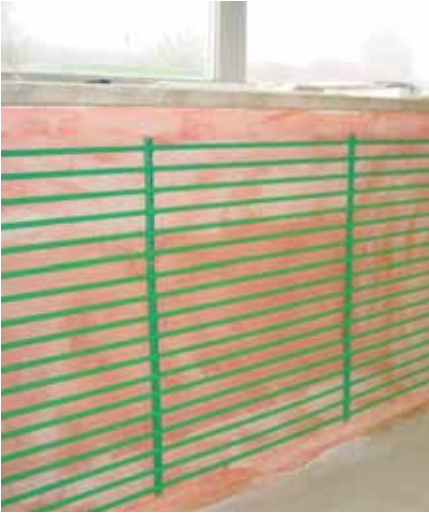

... in dry construction method

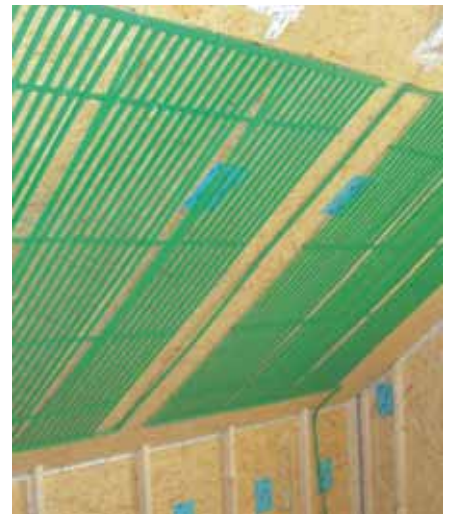







# **Chapter 6**

Wide area application

## Floor construction sports floor

### Spot flexible sports floor

The heating pipes of the spot flexible heating systems for sports floors are laid in a cement or anhydrite floor:

The covering existing of a flexible layer, glass fibre composite and surface floor is glued on the floor pavement.

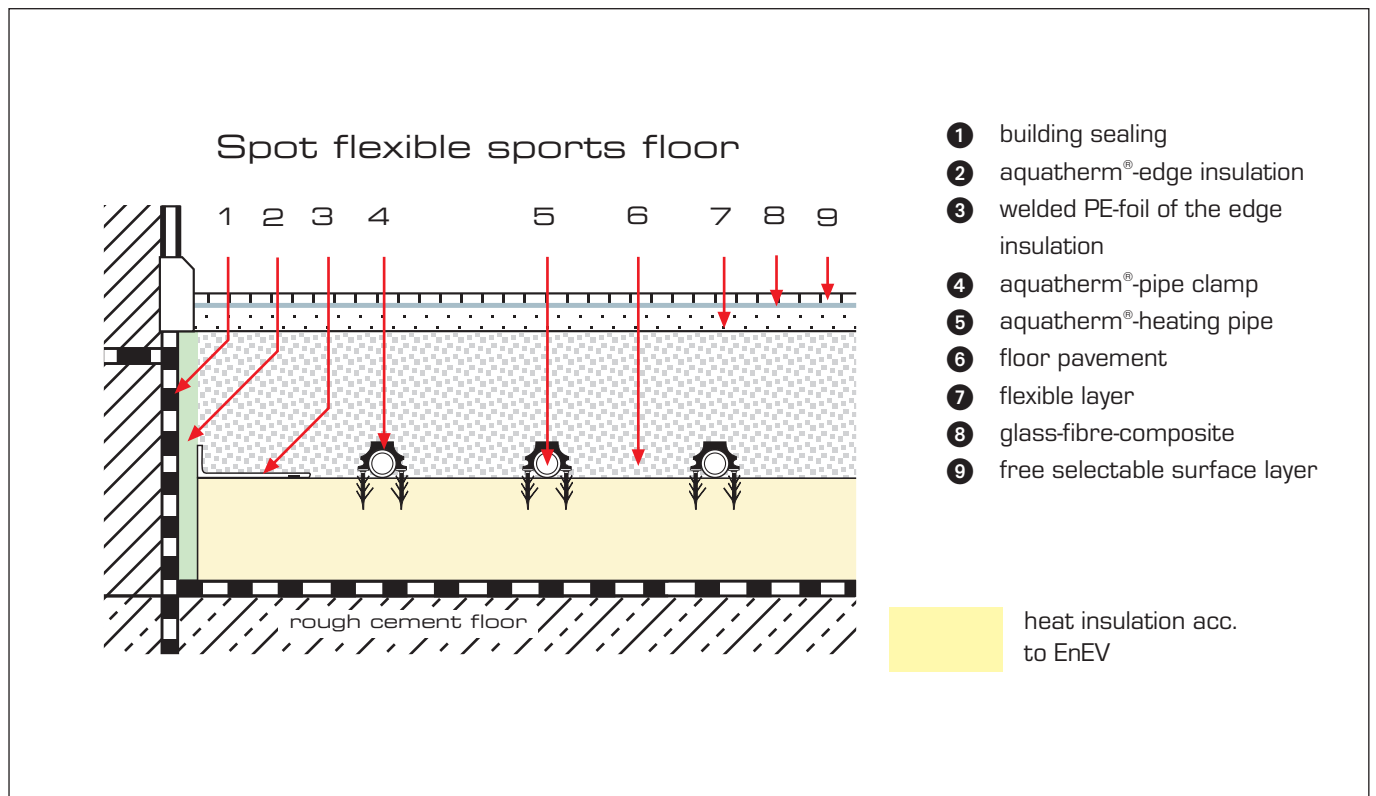

Reg.-No.: 7F051  
7F093

# Floor construction sports floor

## Surface flexible sports floor (double swing floor)

The air space between the insulation and the sports flooring is heated in case of surface flexible sports floor. The construction is made of flexible layers of wood arranged on swing bearers and lining blocks.

Parquet, linoleum, PUR or PVC can be selected as surface covering.

## Design A: Tacker technique with pipe clamps

With this fastening method the heating pipes are fixed on the insulation by means of aquatherm®-pipe clamps. The aquatherm®-tacker enables a fast and secure installation.

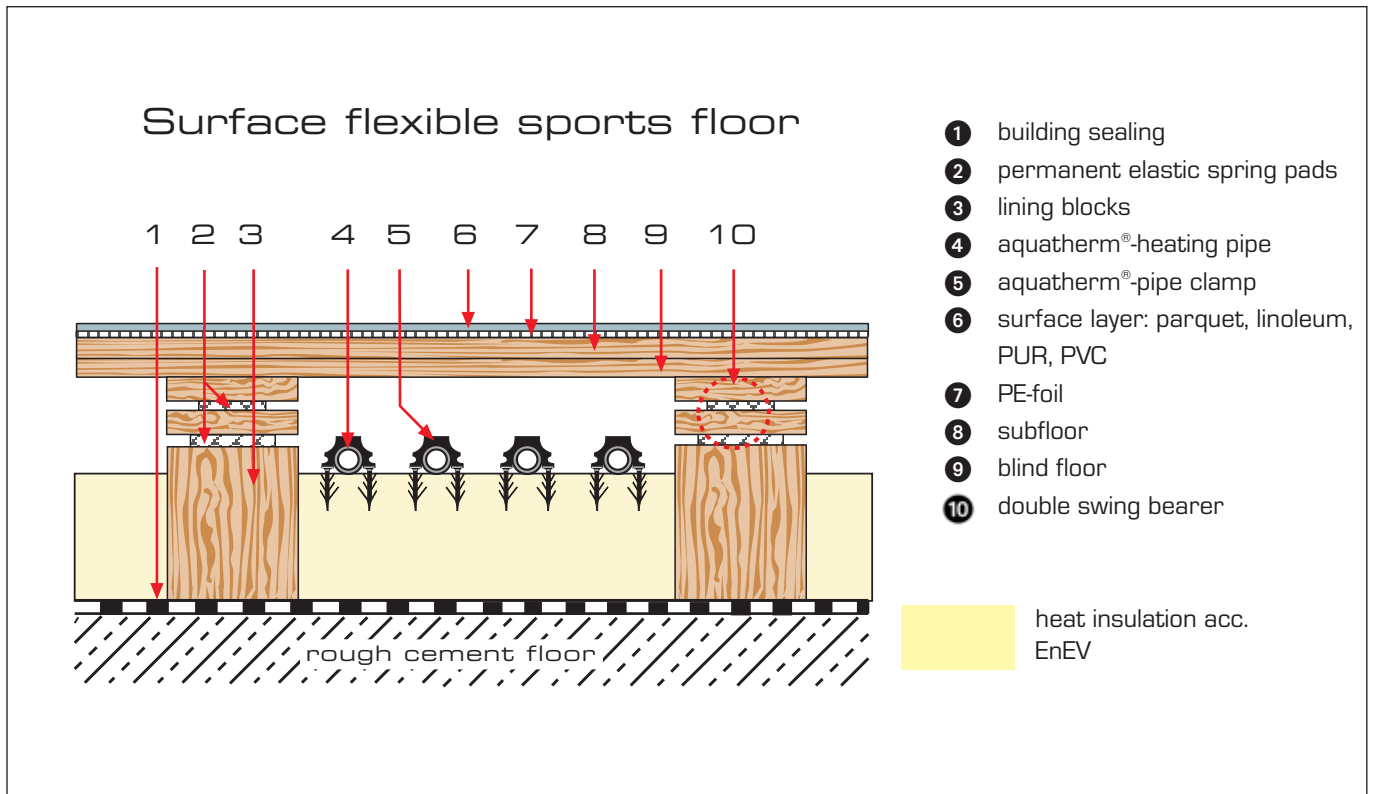

## Floor construction sports floor

### Design B: Pipe guiding rail

#### Fixing of the heating pipes with the aquatherm®-pipe guiding rail.

The aquatherm®-heating pipes are kept on the construction with the aquatherm®-pipe guiding rail lying on the heat insulation.

The pipe guiding rail is hung up securely and firmly in the double swing bearer.

The rail is lengthwise adjustable (2) and therefore suitable for all centre dimensions and model constructions.

All kinds of heat insulation material as boards or rolls can be selected.

Due to infinitely height adjustment (1), the heating pipe always lies on the already installed insulation. That way an exact pipe guiding and therefore an optimum heat distribution is secured. The 20 mm safe distance between the blind floor and heating pipe, required by the FSB, Berlin, is guaranteed by the safety stop (3).

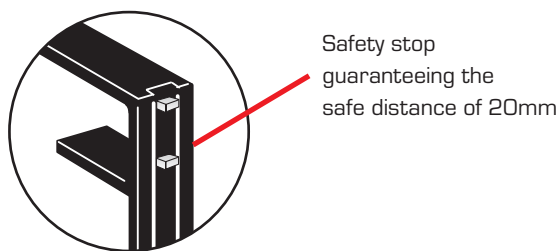

Pipe guiding rail is lengthwise adjustable, with infinitely height adjustment and safety stop

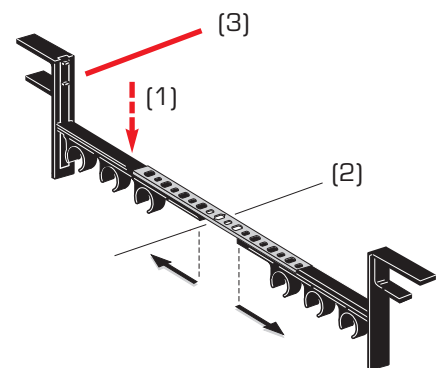

#### Pipe guiding rail

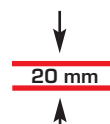
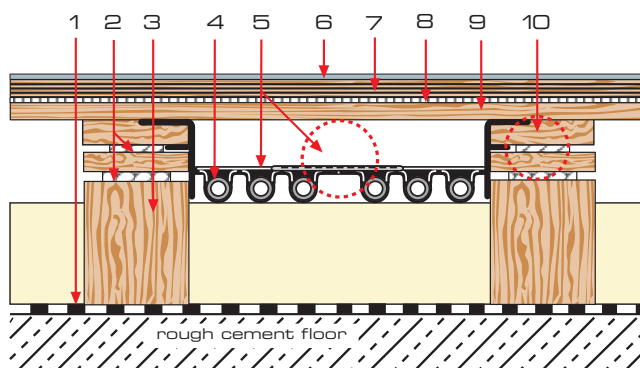

Safe distance from the heating pipe up to lower surface of the blind floor (acc. to code of practise of FSB)

- 1 building sealing
- 2 permanent elastic spring pads
- 3 lining blocks
- 4 aquatherm®-heating pipe
- 5 aquatherm®-pipe guiding rail
- 6 surface layer: parquet, linoleum, PUR, PVC
- 7 load distribution board
- 8 PE-foil
- 9 blind floor
- 10 double swing bearer

 insulation materials as boards or rolls; heat insulation acc. EnEV



Reg.-No.: 7F180

# Floor construction sports floor

## Surface flexible sports floor (assembled flooring)

The surface flexible sports floor is composed of a flexible layer, a load distribution layer resistant to bending and the surface layer.

The aquatherm®-underfloor heating is laid down dry below the construction.

The heating pipes are laid in a polystyrol system component with heat conducting lamellas.

The combination of the aquatherm®-underfloor heating with a surface flexible sports floor in assembled construction offers a maximum of heating comfort.

The protective and sport functional characteristics are met in any situation.

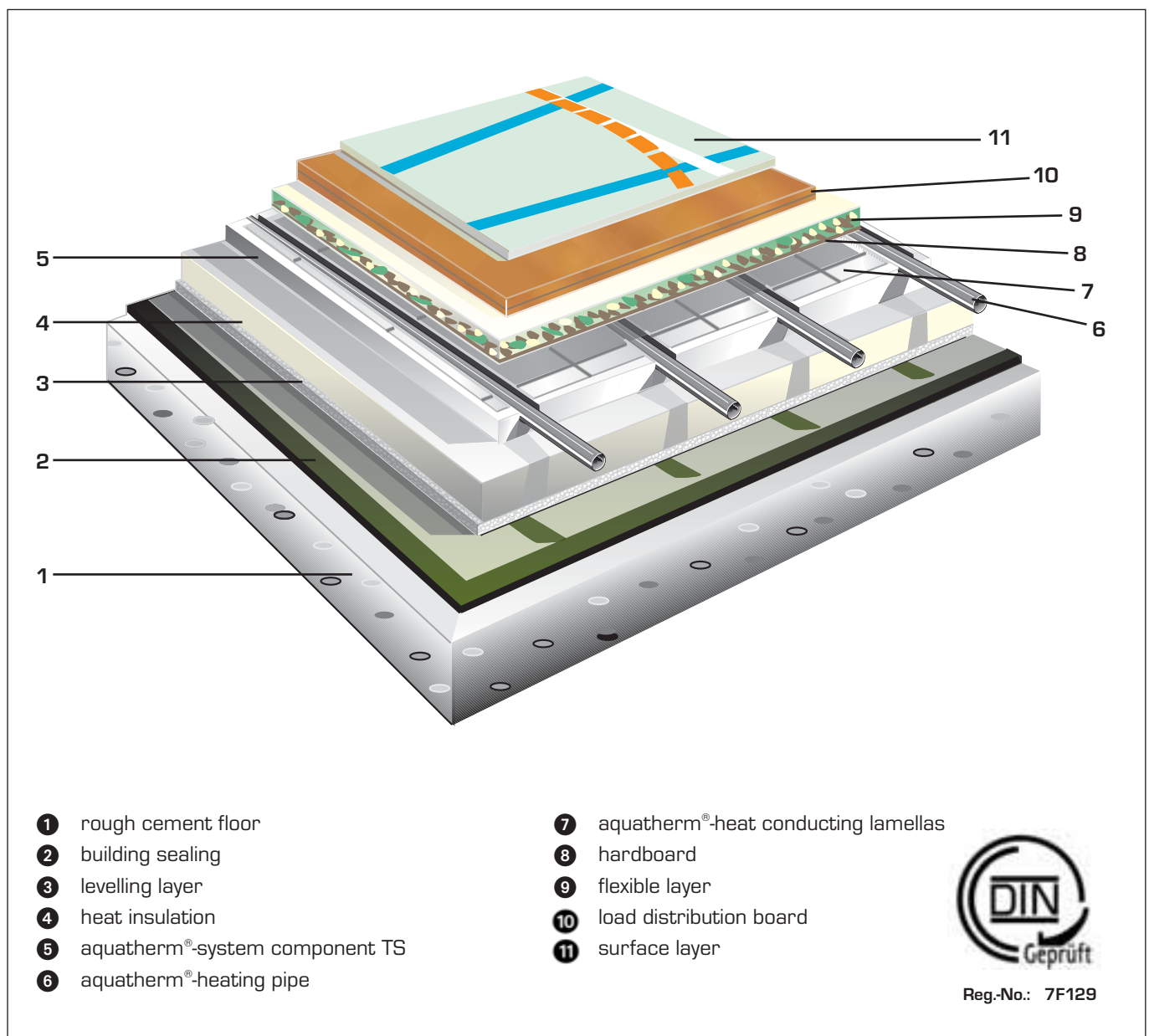

## Floor construction sports floor

### Combined flexible sports floor (assembled flooring)

The flexible layer of the combined flexible sports floor (assembled flooring) is covered by the load distribution layer and the surface of linoleum or PUR-coating. The aquatherm®-system components with heat conducting lamellas are covered e.g. with a plaster faster board of 25 mm thickness.

The heating pipes are lying in a polystyrol system component with heat conducting lamellas. Combined flexible sport floors avoid due to surface stiffening constructions the disadvantages of the small deforming basins of the spot flexible sports floor as well as the hard surface of the surface flexible systems.

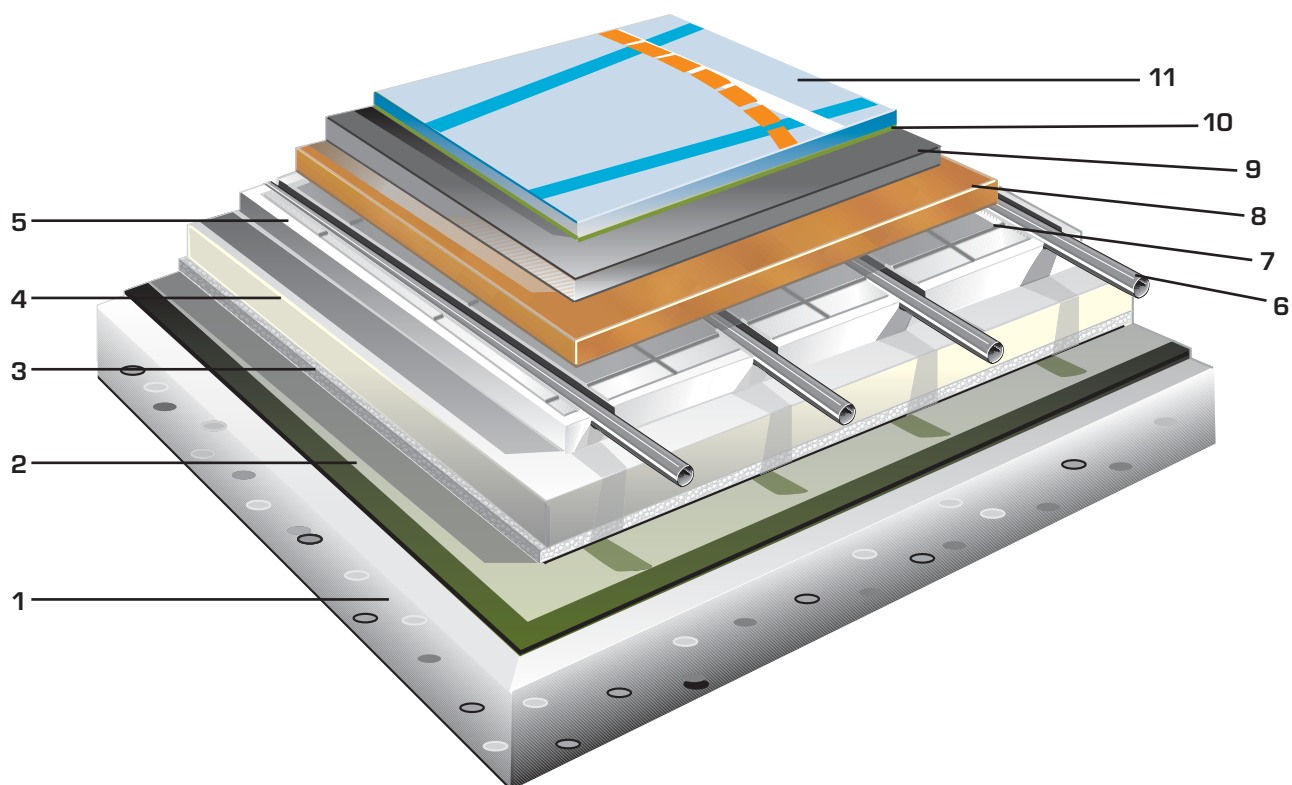

- ① rough cement floor
- ② building sealing
- ③ levelling layer
- ④ heat insulation
- ⑤ aquatherm®-system component TS
- ⑥ aquatherm®-heating pipe

- ⑦ aquatherm®-heat conducting lamellas
- ⑧ plaster faster board
- ⑨ flexible layer
- ⑩ load distribution board
- ⑪ surface layer



Reg.-No.: 7F130



# Industrial surface heating

## Thermal insulation

The decree concerning energy saving thermal insulation in buildings (EnEV) regulates the thermal insulation between heating surface and outside air, the ground or building parts with much lower inside temperature.

The cost of insulation may be out of proportion to the expected energy savings.

The requirements of the Energy Saving Regulation may not be considered, if acc. to

- §1 = premises, acc. to their usual application must kept open for long times
- §2 = the room temperature  $v$  is between 12 and 19° C and the building is heated less than 4 months annually
- §17 = a hardship case due to particular circumstances because of inadequate expenses.

The costs of insulation may constitute a hardship case acc. to § 17. For exemption from thermal insulation duty the following requirements must be met:

- amortisation calculation must be performed
- informal application for "Exemption of thermal insulation duty"
- file an application with amortisation calculation at the building authority
- judgement by the authority (written)

If a thermal insulation is requested or required insulation with high compressive resistance should be used. The insulation must also be inured to humidity.

### Extruder foam:

Extruder foam boards are made from polystyrene acc. to DIN EN 13163. They are often assigned to thermal conductivity group O35 and have a very high compressive resistance due to their apparent density of up to 30 kg / m<sup>3</sup>.

### Cellular glass:

Cellular glass boards are applied for very high loads, where extruder foam boards are not applicable.

Their apparent density is approx. 100 - 150 kg / m<sup>3</sup>.

The boards can be coated with metal foils, plastic- or roofing cardboards or paper.

## Floor coverings (industrial surface heating)

### Ferroconcrete

The most common design for industrial surface heating is made with ferroconcrete.

Ferroconcrete slabs are equipped with upper and bottom reinforcement. Both reinforcement layers are constructed by reinforcement steel meshes whose size and design is calculated by the structural designer.

### Steel fibre concrete

This type of concrete has no mat reinforcement. The concrete is admixed with steel fibres. The quantity depends on the required concrete quality. The fibres are evenly spread in the concrete and thus improve the bending-, pressure- and tensile strength of the concrete. Type and design are specified by the structural designer.

### Vacuum concrete

Vacuum concrete can consist of ferroconcrete, steel fibre concrete or prestressed concrete. The surface is laid out with filter mats and absorbing formwork. A vacuum pump dehumidifies the concrete which improves the reel moisture of the upper concrete layer.

### Rolled concrete

Rolled concrete is build in a very stiff consistency and densified by rolls. This type of concrete due to the drive-ways of the heavy construction vehicles is not suitable for the aquatherm® industrial surface heating.

### Joint arrangement

The type and arrangement of joints is independent from the industrial surface heating and must be specified by the structural designer. The field size depends on various factors.

The heating circuits of the aquatherm® industrial surface heating must be adjusted to the field size. With exception of dummy joints these joints may only be crossed by connection pipes. The connection pipes must be protected with pipe protection sleeves of 1.0 m length in the crossing area.

## Construction models for industrial surfaces

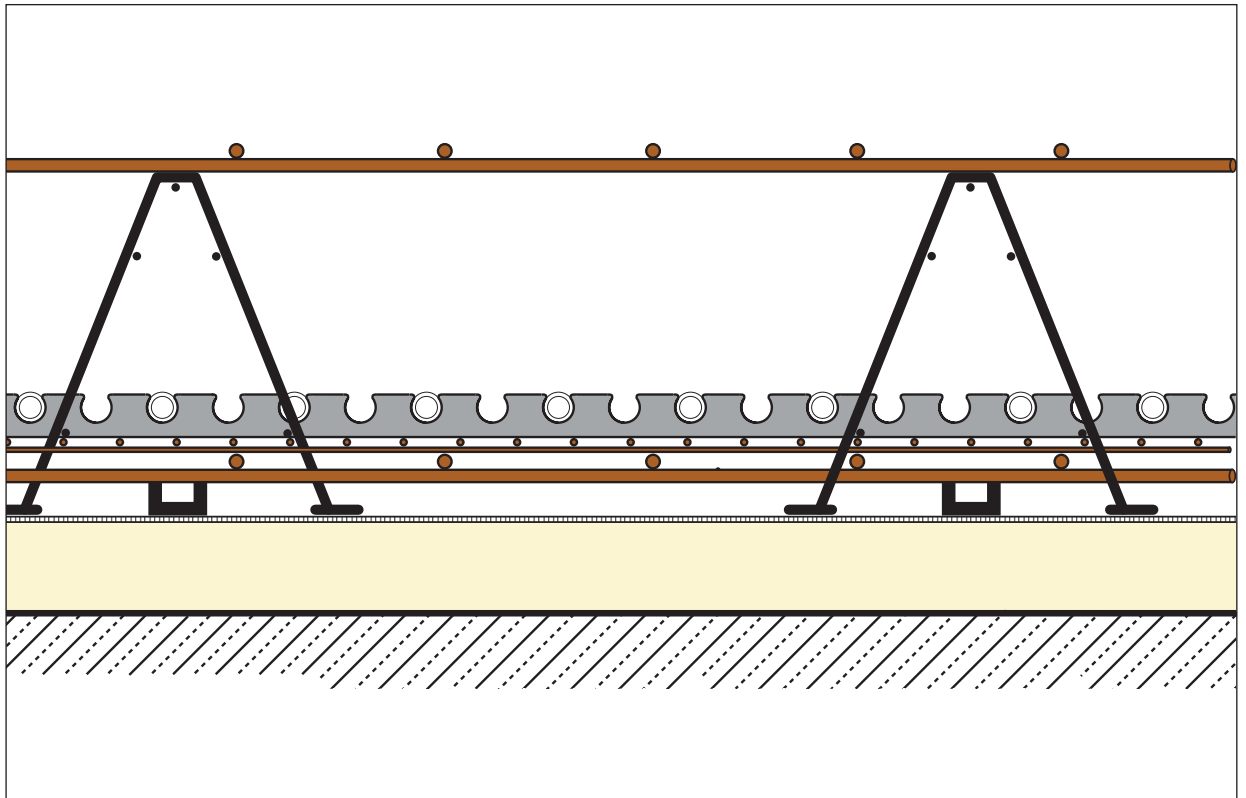
**A**

Construction with profile rail

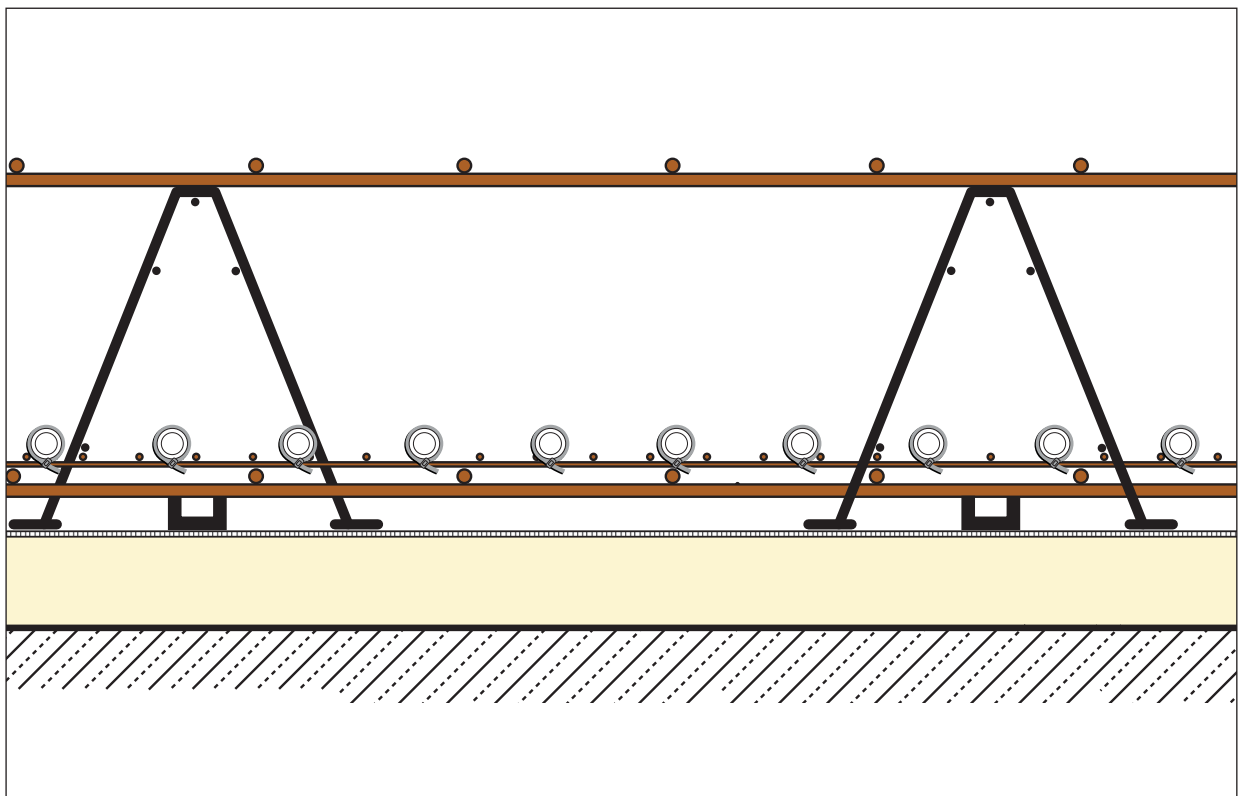
**B**

Construction with cable tie

# Regulations for design / ArbStätt VS6

## Room temperatures / Preconditions

### Industrial surfaces

#### Regulations for design

Heating systems are subject to many DIN-Standards, decrees and regulations. This applies to the system components and also for processing and design.

- Heating System Regulation
- Energy Saving Regulation
- Workplace Regulation
- local regulations and decrees
- DIN 1045 Concrete and Ferroconcrete
- DIN 1055 Load Assumption for Buildings
- DIN 1961 VOB B. and C.
- DIN 4102 Fire Protection
- DIN 4108 Thermal Protection
- DIN EN 12831 Processing for Calculation of the Standard Heating Load
- DIN EN 1264/4725 Underfloor Heating
- DIN 4726 Plastic Pipe Systems
- DIN 4751 Safety-related Equipments of Hot Water Heating Systems
- DIN EN 13/63 Products made of Expanded Polystyrene (EPS)
- DIN 17174 Foam Glass as Insulation
- DIN 18195 Building Sealing
- DIN 18202 Dimension Tolerance
- DIN 18331 Concrete and Ferroconcrete Works
- DIN 18336 Sealing Work
- DIN 18353 Screed Work
- DIN 18380 Heating- and Service Water
- DIN 18560 T7 Screeds in Buildings (Industrial Screeds)

#### ArbStätt VS6

#### Room temperatures

1. Working rooms must have a healthy comfortable room temperature during the working time considering the working process and physical effort of the workers.

Record 1 is also suitable for sectors of working places in stock, machinery- and adjoining rooms.

2. It must be guaranteed, that the workers are not exposed to unhealthy temperatures by heating systems.

3. § 16 Protection against other unhealthy effects

Rooms, where workers stay must be equipped in a way, that the worker is not exposed to avoidable draught. (Extract from Workplace Regulation)

#### Requirements industrial surfaces

Compared to normal house building other requirements must be considered for industrial halls. In case of convection heating systems the room temperature is set 1 to 4 K higher, depending on the hall height, as the room temperature increases with the height. In case of surface heating there is not much of a difference, as the greatest part of the heat output is effected by radiation. For the design of the aquatherm®-industrial surface heating the following parameter must be considered:

- heating load acc. to DIN EN 12831
- heat flow density of underfloor heating  $q$  [W / m<sup>2</sup>]
- concrete covering (see graph)
- pipe spacing
- excess temperature of heating means  $\Delta QH = Q_H - Q_i$  [K]
- excess temperature of floor  $Q_{F,m} - Q_i$  [K]

# Open space heating Design

## Calculation

The calculation of the open space heating system depends on the selected type of operation:

- the surface is kept free from ice and snow **permanently**
- the surface is kept free from ice and snow **for certain times**

Also temperature, humidity, heat output and inertia of the system must be considered for controlling the open space heating system. The aquatherm open space heating is suitable for the installation below pavement embedded in sand or grit, as well as in concrete, in the soil or in mastic asphalt.

Smaller open spaces may be installed with manifolds, like the under floor heating.



Installation of open space heating by reverse return technology



Open space heating: tar-covering of the heating system

## Under soil heating Design / Laying

To keep a pitch with natural or artificial turf free from ice and snow aquatherm offers a system to provide an under soil heating efficiently and effectively, even under consideration of environmental aspects. The ideal combination of climatherm and fusiotherm®-compounds, permanently connected by fusion welding, creates the desired effect.

The weld-in saddle technique, developed by aquatherm is used for the distribution pipes, manufactured like the manifold connection pipes from climatherm-faser composite pipes. The distribution pipes are connected by reverse return (Tichelmann-principle). The heating pipes may be laid in crosswise or lengthwise direction of the pitch. The positioning of the manifolds depends on the structural conditions and the position of the stadium. The laying of the under soil heating, designed by aquatherm, is effected in counter flow principle.

Uncontrolled loss of energy and heat, arising above the pipework in areas which may not be used for heating the pitch must be avoided. Hence, these pipes must be insulated with a material suitable for the installation under soil. For this purpose the pipes and fittings are insulated with a PUR-insulation in PE-pipe by the manufacturer.

### Pull in installation principle

This technique is used in renovations and is installed above the drainage layer before the main lawn layer. This is when the pull in principle can be used. At renovation and modernisations of an existing sports field, on which the lawn is not replaced, the heating pipes are installed by the special pull in principle.

### Placing of rails

Where the pitch is newly constructed the heating pipes are placed on the finished drainage layer. The pipes are fixed on the mounting rail so that the pipe spacing of the heating pipes is even over the total area. After completion of the installation the turf carrying layer is placed, which must cover the pipes by 20 – 25 cm.



Pull in installation principle



Placing of rails

# Undersoil heating Construction

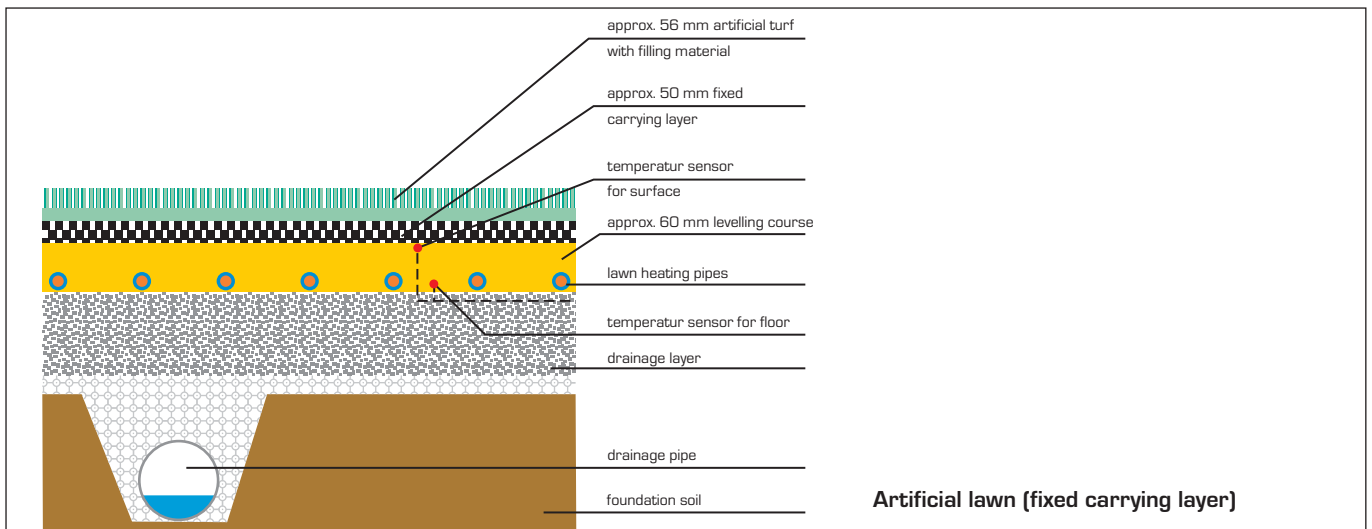
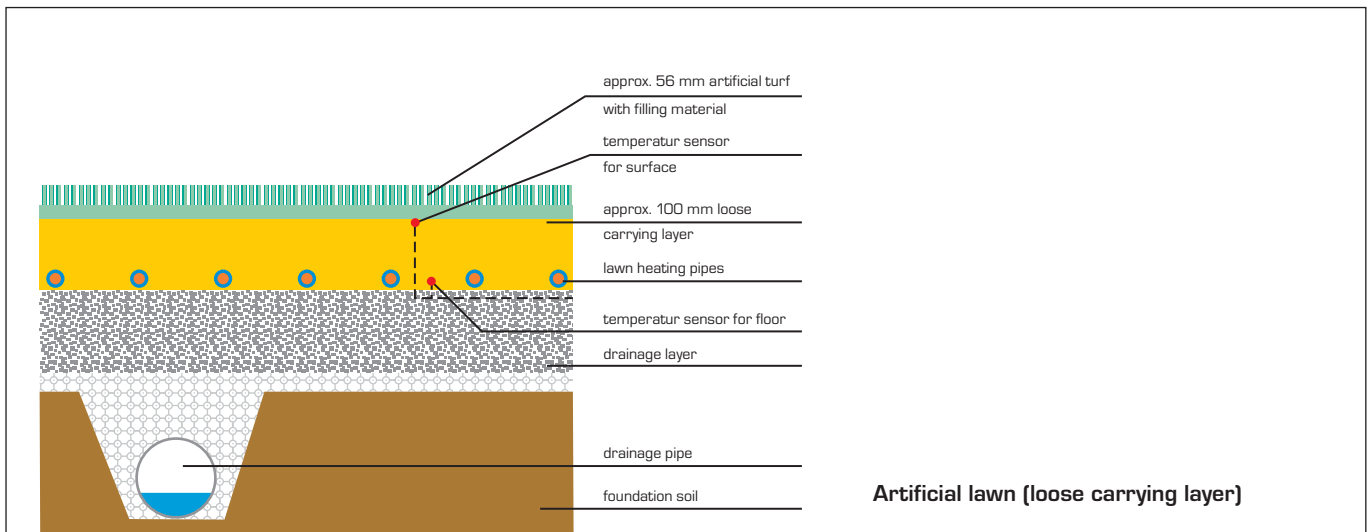
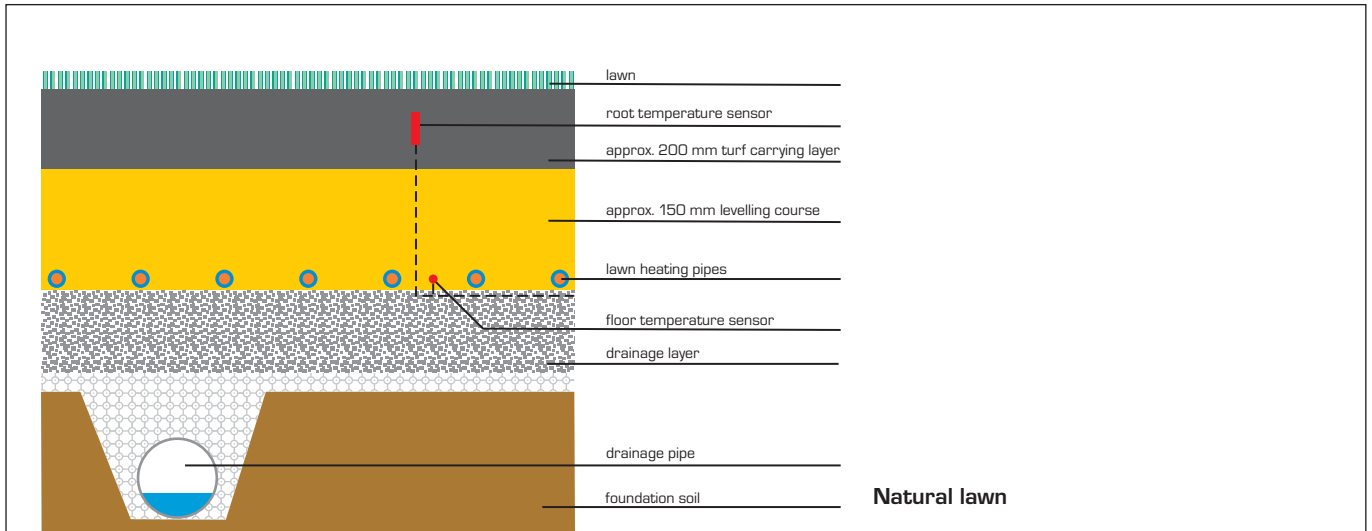

## Ice surface cooling Design and laying

The ice surface cooling system is made of an ideal combination of climatherm and fusiotherm®-components. For the construction of mobile ice rink surfaces the pipework is completed with aquatherm-climatherm components. All components are permanently connected by fusion welding and thus are especially well suited for this field of application.

The distribution pipes as well as the manifold connecting pipes are made from climatherm pipes and connected by reverse return (Tichelmann-principle). The weld-in saddle technique, developed by aquatherm, is applied for the production of manifold branches.

For the construction of ice rink surfaces, equipped with an underfloor chilling system, aquatherm offers a suitable surface cooling system.



Ice surface cooling



Ice surface cooling







# **Chapter 7**

## Planning and Design

## Regulations / decrees / laws

### Regulations / decrees / laws

The following laws, decrees, instructions and standards have to be considered for planning and installation of heating systems:

- ➡ **Energy saving law (EnEG)**
- ➡ **Energy saving regulation - EnEV**

### Heating technology

- ➡ DIN 1961 Contract procedure for building works B and C
- ➡ DIN 4102 Fire protection
- ➡ DIN 4108 Thermal insulation in high buildings
- ➡ DIN 4109 Sound insulation in high buildings
- ➡ DIN EN 12831 Heating systems in buildings, procedure for calculation of standard heat charge
- ➡ DIN EN 1264 Hot-water underfloor heating systems
- ➡ DIN 4726 Pipelines of plastic for hot-water floor heating systems
- ➡ DIN 4751 Safety equipment of hot-water heating systems
- ➡ DIN 18380 Heating and service water heating systems

# Calculation

## Calculation

In general an exact heat requirement calculation as per DIN 4701 has to be made prior to the design of an aquatherm®-underfloor heating system. The calculation of the pipe distances is made in accordance with the performance output characteristics of the single pipe distances.

The surface covering should be known when planning. In objects for which the covering will be determined afterwards, the most unfavourable but still allowable covering should be planned. Same is also valid for rooms, in which a change of covering is to be expected later on.

In rooms with stone coverings experience showed that the floor will usually be covered with rugs, carpets etc. Due to this a correction of the planning is necessary.

## Floor surface temperature

The following floor surface temperatures should not be exceeded for physiological and medical reasons:

- 29° C in rooms (domestic and office buildings)
- 35° C in edge areas
- 33° C in bathrooms and indoor swimming pools.

When calculating the rooms, it should be checked if the max. allowed floor temperature is kept by the selected pipe distance.

For rooms in which the specific heat requirement does not guarantee the compliance of the surface temperature any longer, planning of additional heating surfaces should be considered. The fact that the standard-outside temperature as indicated in DIN 4701 only occurs on a few days shows that the actual floor surface temperature is considerably below the theoretically determined values.

## Basis of calculation

The following documents are required to calculate the aquatherm®-underfloor heating system:

- ➡ the complete constructional drawings
- ➡ the standard heat requirement calculation as per DIN 4701
- ➡ the output characteristics of the pipe distances
- ➡ the pressure loss diagrams of the valves
- ➡ the pressure loss diagram of the heating pipes

When designing the rooms the adjusted heat requirement  $\Phi_{Ber}$  [W] can be taken into account and is calculated as follows:

$$\begin{array}{l} \Phi_N \quad \text{standard heat load} \\ - \Phi_{FB} \quad \text{heat flow through the floor} \\ \hline = \Phi_{Ber} \quad \text{adjusted heat requirement [W]} \end{array}$$

The standard heat load  $\Phi_{HL}$  is decisive for the design of the boiler and the calculation of the water quantity. The adjusted specific heat requirement  $q_h$  [W/m<sup>2</sup>] is calculated according to the following formula:

$$q_h = \frac{\Phi_{Ber} \quad \text{adjusted heat load [W]}}{A_R \quad \text{room surface [m}^2\text{]}}$$

## Method of calculation

The method of calculation is made as per DIN EN 1264. The surface temperature is limited in accordance with the respective design area. The return temperature is limited variably to at least  $\vartheta_i + 2^\circ$  C for every room so that a hydraulic room adjustment is possible.

## Connection supplies

Connection supplies are pipes between the manifold and the circuit.

If the connection supplies are running through another room with an individual circuit they must have an identical pipe distance acc. to the surface design. These continuous connection supplies can be designed with the same thermal output as the circuit. For determination of the total circulating water quantity the continuous connection length must be corrected correspondingly.

## Edge areas

Pipes in edge areas can be laid in closer distances as these areas are not used so frequently. The surface temperatures may be higher compared to the occupied zone. Higher heat losses e.g. due to large-surface glasses can be considered and compensated.

## Calculation / Occupied zone

The width of edge areas should not exceed 1.0 m. Moreover, edge areas should be placed all-over the outside wall in which the window is arranged.

In case that the pipe spacing in the occupied zone is PS 100 or PS 150 the pipe spacing (PS) of the edge area should be PS 75. For a pipe spacing of PS 200 to PS 300 same should be PS 100.

If the edge area has to produce extremely high heating output, a PS 50 is recommended. In general the edge area should be designed as an independent heating circuit, i.e. with an own connection supply.

For small rooms with a condensed perimeter zone the integrated design should be selected, i.e. condensed perimeter zone area and occupied zone are laid as a combined heating circuit.

### Occupied zone

The occupied zones are laid according to the calculated pipe spacing. Pipe spacings of more than 30 cm are only allowed in exceptional cases due to the high differences of the floor surface temperatures.

#### **Kitchen:**

As during the planning phase the covered surface is in most cases not known due to built-in furniture, a minimum PS of 150 should be planned and laid (considering the max. allowed surface temperature). Voids below built-in furniture should be avoided if possible.

#### **Baths:**

In bathrooms, toilet areas and going round areas of swimming pools a pipe spacing of at least PS 100 mm has to be planned and laid (considering the maximum allowed surface temperature) as a direct foot contact is most frequently here.

# Floor surface coverings / symbols / rugs

## Floor surface coverings

Floor surface coverings have an important influence on the heat flux density of underfloor heating systems. The thermal resistance of floor coverings depends on the nature of the materials.

The maximum temperature delay of floor coverings is  $R_{\lambda B} = 0.15 \text{ m}^2 \text{ K} / \text{W}$ . For carpets the temperature delay of the floor and the possibly used sub layer must be added.

### Standard values for surface coverings

<b>tiles</b>	approx. 0.01 - 0.02 $\text{m}^2 \text{ K} / \text{W}$
<b>marble</b>	approx. 0.01 - 0.025 $\text{m}^2 \text{ K} / \text{W}$
<b>carpet</b>	approx. 0.05 - 0.15 $\text{m}^2 \text{ K} / \text{W}$
<b>parquet / laminate</b>	approx. 0.035 - 0.150 $\text{m}^2 \text{ K} / \text{W}$
<b>PVC, lino</b>	approx. 0.025 - 0.075 $\text{m}^2 \text{ K} / \text{W}$

### Symbols “suitable for underfloor heating systems“

Carpeted floors and elastic layers which are suitable for placing on under floor heating systems are provided with a corresponding symbol by the manufacturer



carpets



elastic coverings

### Use of rugs

If loose carpets or rugs are placed on stone floors, PVC, parquet or laminate the medium thermal resistance  $R_{\lambda B}$  has to be determined in accordance with the surface interest using the following formula.

$$R_{\lambda Bm} = \frac{A_{Ges} \cdot R_{\lambda D} + A_B \cdot R_{\lambda T}}{A_{Ges}}$$

- $R_{\lambda B}$  = medium thermal resistance
- $A_{Ges}$  = total surface
- $A_B$  = surface covered with loose carpet
- $R_{\lambda D}$  = thermal resistance surface covering
- $R_{\lambda T}$  = thermal resistance carpet

### Calculation example:

medium thermal resistance

#### Example:

30.0  $\text{m}^2$  stone tiles  $R_{\lambda D} = 0.02 \text{ m}^2 \text{ K} / \text{W}$  covered with  
 10.0  $\text{m}^2$  carpet  $R_{\lambda T} = 0.10 \text{ m}^2 \text{ K} / \text{W}$

#### Result:

$$R_{\lambda Bm} = \frac{30 \text{ m}^2 \cdot 0.02 \text{ m}^2 \text{ K} / \text{W} + 10 \text{ m}^2 \cdot 0.10 \text{ m}^2 \text{ K} / \text{W}}{30 \text{ m}^2 + 10 \text{ m}^2}$$

$$R_{\lambda Bm} = 0.053 \text{ m}^2 \text{ K} / \text{W}$$

## Heating circuit length / Manifold connection area / Material requirement

### Heating circuit length

The maximum allowed heating circuit length for aquatherm®-underfloor heating systems depends on the pipe dimension applied.

14 x 2.0 mm = max. heating circuit length = 100 m  
 16 x 2.0 mm = max. heating circuit length = 120 m  
 17 x 2.0 mm = max. heating circuit length = 125 m  
 20 x 2.0 mm = max. heating circuit length = 160 m

Rooms in which the design requests greater pipe lengths should be divided into several heating circuits - if possible - of the same length, in order to guarantee a hydraulic compensation of the heating system. It should be considered that even for heating circuits up to a maximum length a partition into 2 heating circuits is necessary, if the pressure loss exceeds 350 mbar.

### Manifold connection area

All feed pipes in front of the manifold are placed close together. As these connection pipes also convey heat it might be possible that the surface temperature is higher than the allowed value.

In this case a respective number of connection pipes should be insulated.

### Material requirements

The bill of quantity of the aquatherm system components can be made in accordance with the following table.

Material requirements		A50	PS 75 <sup>1</sup>	PS100	PS150	PS 200	PS 250	PS 300
Heating pipe	m	A x 19.0	A x 12.5	A x 9.5	A x 6.25	A x 5.0	A x 4.0	A x 3.5
Pipe clips <sup>2</sup>	Pc	A x 40.0	A x 25.0	A x 20.0	A x 15.0	A x 10.0	A x 8.0	A x 7.0
Alternatively for pipe clips: spring rail <sup>3</sup>	m	A x 1.0	A x 1.0	A x 1.0	A x 1.0	A x 1.0	A x 1.0	A x 1.0
Edge insulation	m	A x 1.0	A x 1.0	A x 1.0	A x 1.0	A x 1.0	A x 1.0	A x 1.0
Screed additive	kg	A x 0.15	A x 0.15	A x 0.15	A x 0.15	A x 0.15	A x 0.15	A x 0.15
Screed additive special floor mix	kg	A x 1.45	A x 1.45	A x 1.45	A x 1.45	A x 1.45	A x 1.45	A x 1.45
System elements	m <sup>2</sup>	A x 1.0	A x 1.0	A x 1.0	A x 1.0	A x 1.0	A x 1.0	A x 1.0

A: heating surface [m<sup>2</sup>]

PS: pipe spacing [mm]

<sup>1</sup> Pipe spacing 75 mm is not possible when using the system element knob plate

<sup>2</sup> Pipe holder devices are not necessary when using the system element knob plate

<sup>3</sup> Spring rail is not suitable for the system element knob plate



# Thermal output as per DIN EN 1264

## Thermal output as per DIN EN 1264

Until now the selection of the laying distances has been made in accordance with the thermal output of the respective system supplier.

A comparison of suppliers with the same system constructions was nearly impossible due to different data of power. With DIN EN 1264 a uniform calculation procedure has been introduced enabling to determine the power data of all underfloor heating systems. Power differences of comparable systems with the same construction are not longer possible.

The thermal output of a underfloor heating system in the wetlaying procedure can be calculated based on the following formula:

$$\dot{q} = B \cdot a_B \cdot a_T^{m_T} \cdot a_{\ddot{U}}^{m_{\ddot{U}}} \cdot a_D^{m_D} \cdot \Delta\vartheta_H$$

Explanation:

B	influence of the pipe material, the pipe wall thickness and a possible pipe shell on the heat flux density
$a_B$	factor of the floor covering
$a_T$	division factor (pipe distance)
$a_{\ddot{U}}$	covering factor
$a_D$	factor of the external diameter of the pipe
$\Delta\vartheta_H$	excess temperature of heating means
$m_T$	$1 - \frac{T}{0.075}$ (valid f. pipe systems $0.050 \leq T \leq 0.375$ m)
$m_{\ddot{U}}$	100 (0.045 m - Sü) (valid f. pipe coverings $Sü \leq 0.015$ m)
$m_D$	250 (D - 0.020 m) (valid f. pipe diameters $0.012$ m $\leq$ D $\leq$ 0.030 m)

aquatherm®-underfloor heating systems correspond to the system construction A and C as per DIN EN 1264-1.

Using (CT) cement screed of class F4 for vertical load  $\leq 2.0$  kN / m<sup>2</sup> screed thickness of 45 mm (plus outside diameter of heating pipe) has to be considered.

The specific outputs for the individual system constructions can be gathered from the tables on 164-170.

The performance characteristic describes the connection between the heat output  $q$  and the required excess temperature of the heating means  $\Delta\vartheta_H$ , whereas the temperature delay for four floor coverings has been considered also.

The excess temperature for the heating means  $\Delta\vartheta_H$  is calculated as a logarithmic means from the flow temperature  $\vartheta_V$ , the return temperature  $\vartheta_R$  and the room temperature  $\vartheta_i$ . Consequently the influence of the temperature difference has been determined.

$$\Delta\vartheta_H = \frac{\vartheta_V - \vartheta_R}{L^n \frac{\vartheta_V - \vartheta_i}{\vartheta_R - \vartheta_i}}$$

## Flow temperature / DIN CERTCO registration

### Flow temperature

Upon determination of the flow temperature a temperature delay of the floor covering of  $R_{\lambda,B} = 0.10 \text{ m}^2 \text{ K/W}$  is assumed in accordance with the **standards for recreation rooms**.

For bath  $R_{\lambda,B} = 0.00 \text{ m}^2 \text{ K/W}$ .

The temperature difference of the heating circuit in the most unfavourable room is max. 5 K. The other rooms have larger differences depending on the heat requirement, pipe distance, floor covering and excess temperature of the heating means. Consequently the medium heat flow of a complete system is determined as a mixed value of the medium heat flow of all heating circuits and can not be calculated with a predicted difference.

By the limitation of the floors' surface temperature limit values of the heat flux density arise depending on the floor surface. These limiting curves are drawn in the graphs and **must not be exceeded**.

The flow temperature  $\vartheta_{V,Ausl.}$  is calculated as follows:

$$\vartheta_{V,Ausl.} = \vartheta_i + \Delta\vartheta_{H,Ausl.} + \frac{\sigma}{2}$$

If the ratio is  $\sigma / \Delta\vartheta_H > 0.5$  the flow temperature has to be calculated as follows:

$$\vartheta_{V,Ausl.} = \vartheta_i + \Delta\vartheta_{H,Ausl.} + \frac{\sigma}{2} + \frac{\sigma^2}{12 \Delta\vartheta_{H,Ausl.}}$$

For all remaining rooms operated with the flow temperature the respective expansions have to be calculated according to the following formula...

$$\sigma_i = 2 \cdot [(\vartheta_{V,Ausl.} - \vartheta_i) - \Delta\vartheta_{Hj}]$$

...as far as the ratio is  $\sigma_i / \Delta\vartheta_H \leq 0.5$ .

At a ratio of  $\sigma_i / \Delta\vartheta_H \leq 0.5$  the differences are calculated as follows:

$$\sigma_i = 3 \cdot \Delta\vartheta_{Hj} \sqrt{1 + \frac{4 (\vartheta_{V,Ausl.} - \Delta\vartheta_{Hj})}{3 \cdot \Delta\vartheta_{Hj}} - 1}$$

### DIN CERTCO registration

DIN CERTCO gave the allowance to mark with the following register-no.:

For valufix-system with heating pipe 16 x 2 mm:

**7 F 051**

For valufix-system with heating pipe 17 x 2 mm:

**7 F 052**

For valufix-system with heating pipe 20 x 2 mm:

**7 F 093**

For surface elastic sports floors SB 4 with heating pipe 20 x 2 mm:

**7 F 180**

For surface elastic sports floors TS with heating pipe 16 x 2 mm:

**7 F 129**

For mixed elastic sports floors TS with heating pipe

16 x 2 mm:

**7 F 130**

# Pressure loss graphs

## Pressure loss graphs

aquatherm®-pipes with dimension 16 x 2.0 mm

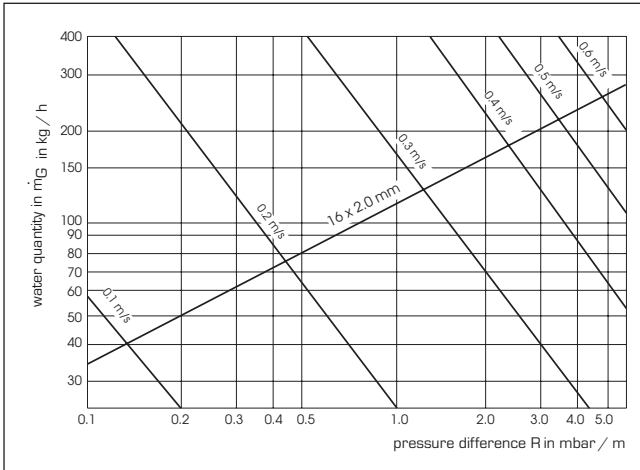

aquatherm®-pipes with dimension 20 x 2.0 mm

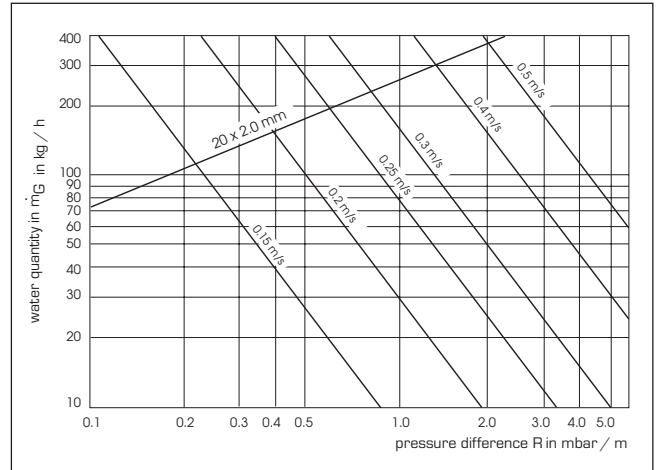

aquatherm®-pipes with dimension 17 x 2.0 mm

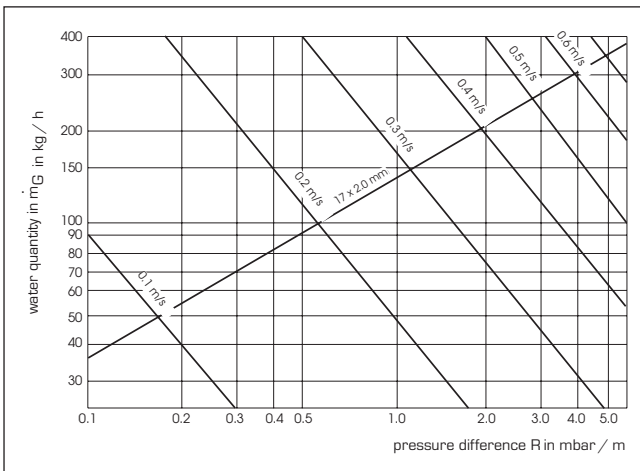

## Graph of heat output

Graphs of heat output valid for heating pipe 16 x 2 mm with 45 mm screed covering with a pipe spacing PS of 50 mm

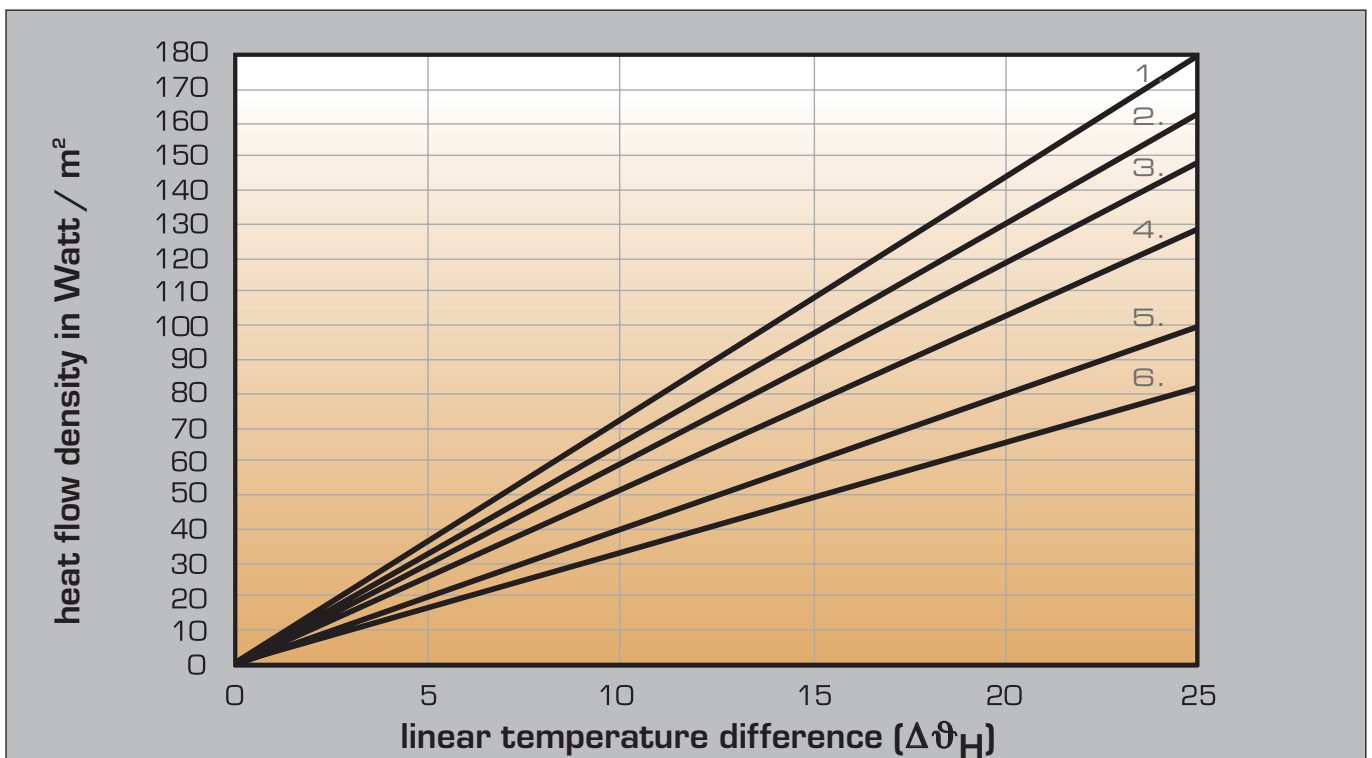

Thermal resistance of surface covering

- ① without surface covering: 0 m²K / W
- ② floor tiles ≤ 15 mm: 0.015 m²K / W
- ③ floor tiles ≤ 25 mm: 0.03 m²K / W
- ④ parquet 10 mm: 0,05 m²K / W
- ⑤ carpet: 0.1 m²K / W
- ⑥ carpet: 0.15 m²K / W

## Graph of heat output

Graphs of heat output valid for heating pipe 16 x 2 mm with 45 mm screed covering with a pipe spacing PS of 75 mm

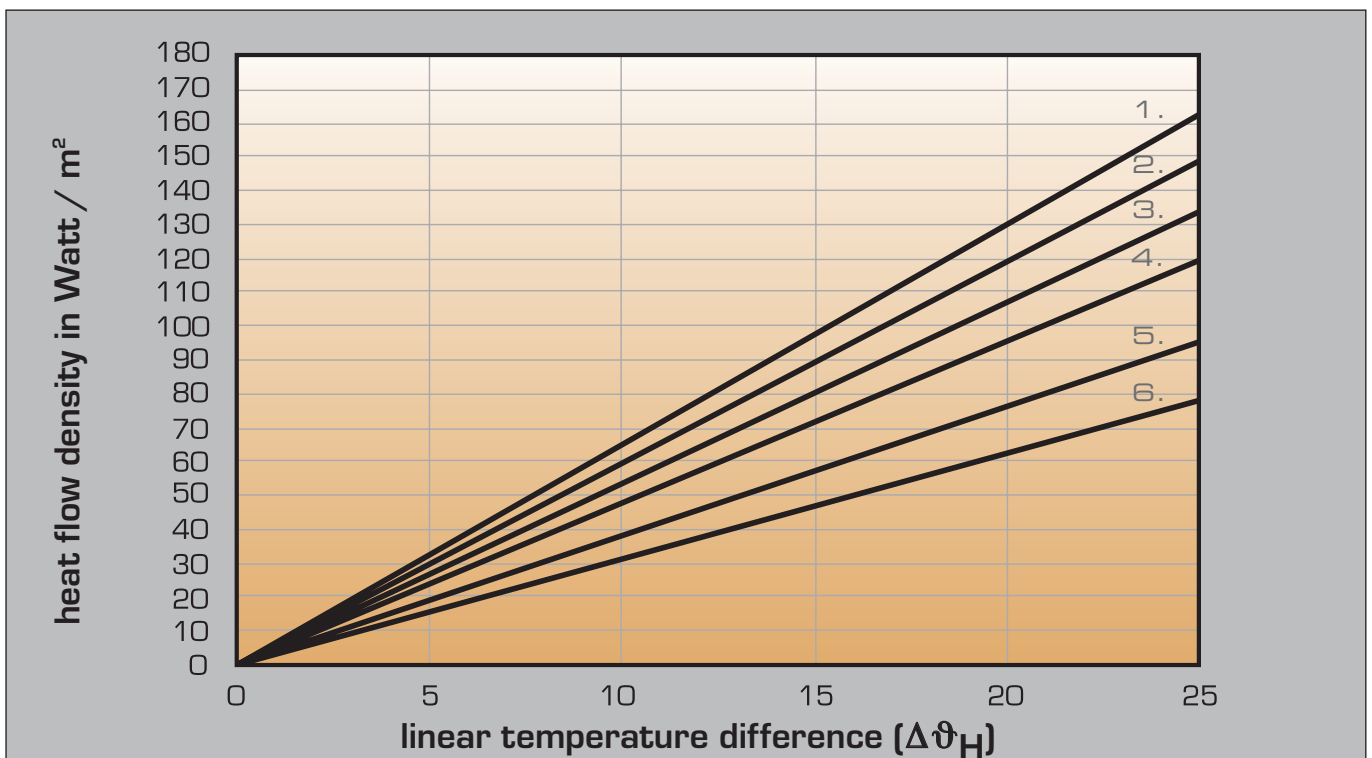

Thermal resistance of surface covering

- ① without surface covering: 0 m<sup>2</sup>K / W
- ② floor tiles ≤ 15 mm: 0.015 m<sup>2</sup>K / W
- ③ floor tiles ≤ 25 mm: 0.03 m<sup>2</sup>K / W
- ④ parquet 10 mm: 0.05 m<sup>2</sup>K / W
- ⑤ carpet: 0.1 m<sup>2</sup>K / W
- ⑥ carpet: 0.15 m<sup>2</sup>K / W

## Graph of heat output

Graphs of heat output valid for heating pipe 16 x 2 mm with 45 mm screed covering with a pipe spacing PS of 100 mm

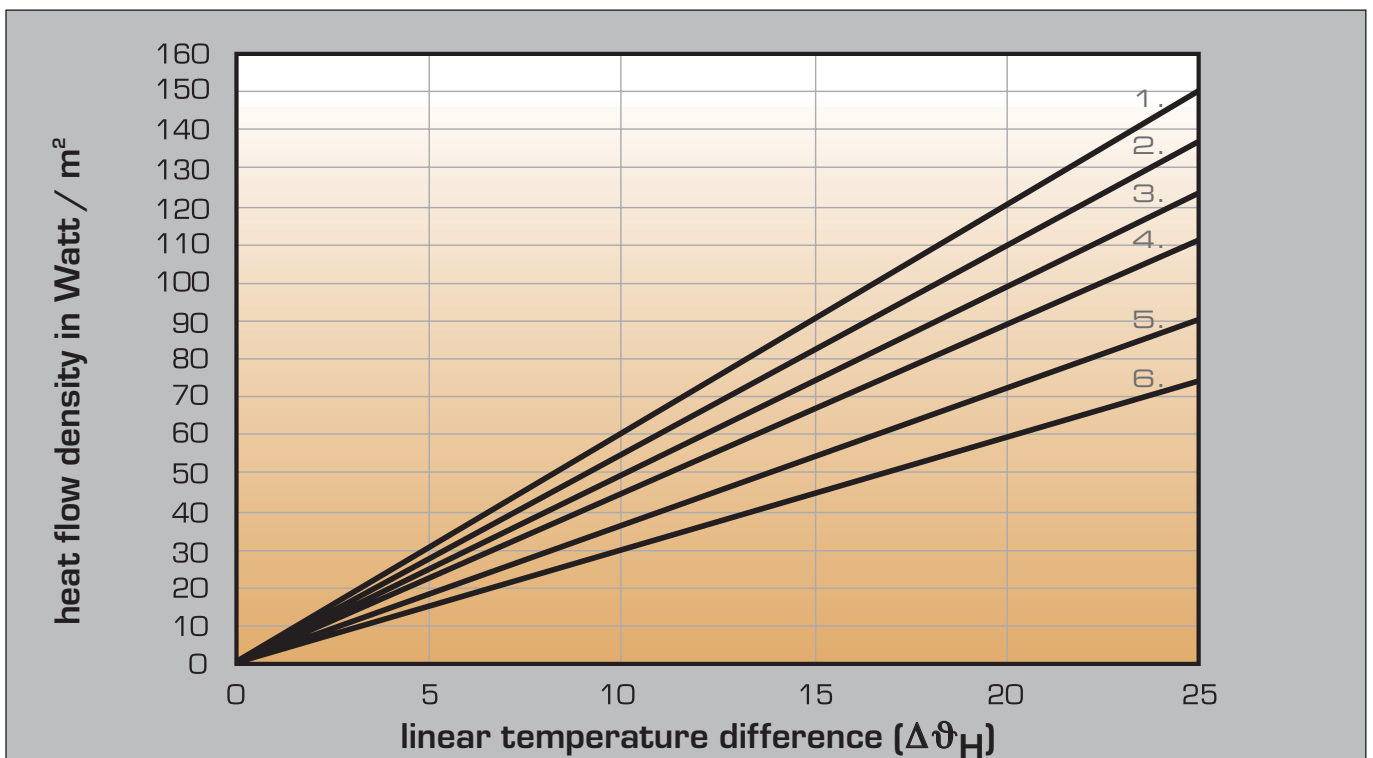

Thermal resistance of surface covering

- ① without surface covering: 0 m²K / W
- ② floor tiles ≤ 15 mm: 0.015 m²K / W
- ③ floor tiles ≤ 25 mm: 0.03 m²K / W
- ④ parquet 10 mm: 0.05 m²K / W
- ⑤ carpet: 0.1 m²K / W
- ⑥ carpet: 0.15 m²K / W

## Graph of heat output

Graphs of heat output valid for heating pipe 16 x 2 mm with 45 mm screed covering with a pipe spacing PS of 150 mm

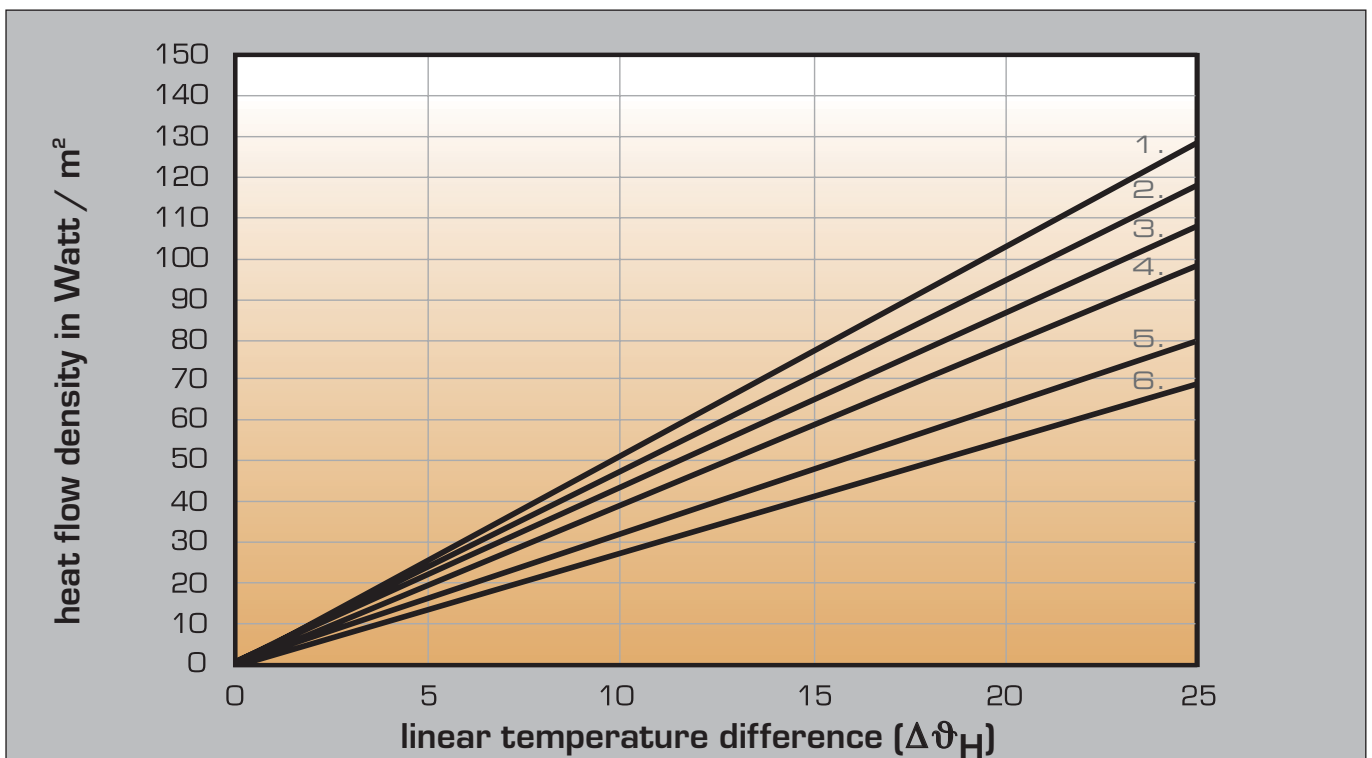

Thermal resistance of surface covering

- ① without surface covering: 0 m²K / W
- ② floor tiles ≤ 15 mm: 0.015 m²K / W
- ③ floor tiles ≤ 25 mm: 0.03 m²K / W
- ④ parquet 10 mm: 0.05 m²K / W
- ⑤ carpet: 0.1 m²K / W
- ⑥ carpet: 0.15 m²K / W

## Graph of heat output

Graphs of heat output valid for heating pipe 16 x 2 mm with 45 mm screed covering with a pipe spacing PS of 200 mm

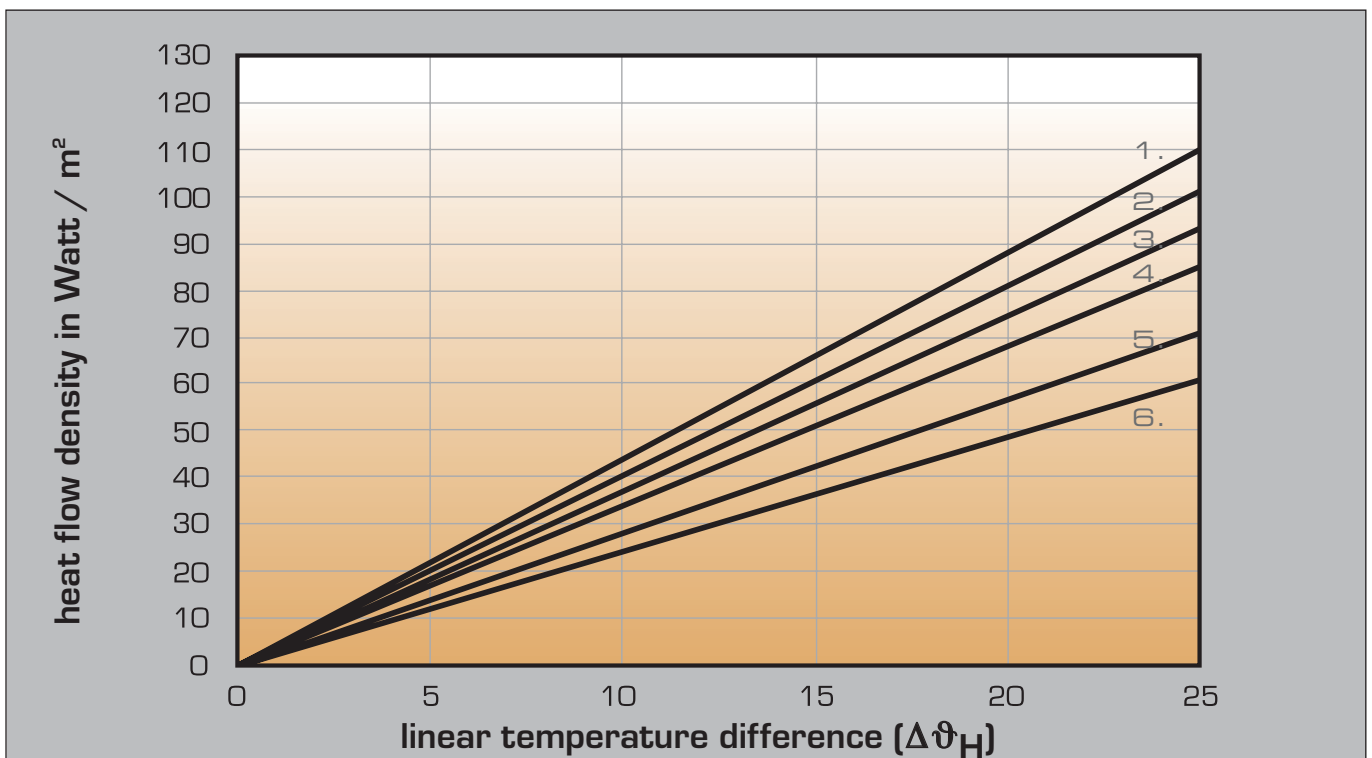

Thermal resistance of surface covering

- ① without surface covering: 0 m²K / W
- ② floor tiles ≤ 15 mm: 0.015 m²K / W
- ③ floor tiles ≤ 25 mm: 0.03 m²K / W
- ④ parquet 10 mm: 0.05 m²K / W
- ⑤ carpet: 0.1 m²K / W
- ⑥ carpet: 0.15 m²K / W



## Graph of heat output

Graphs of heat output valid for heating pipe 16 x 2 mm with 45 mm screed covering with a pipe spacing PS of 250 mm

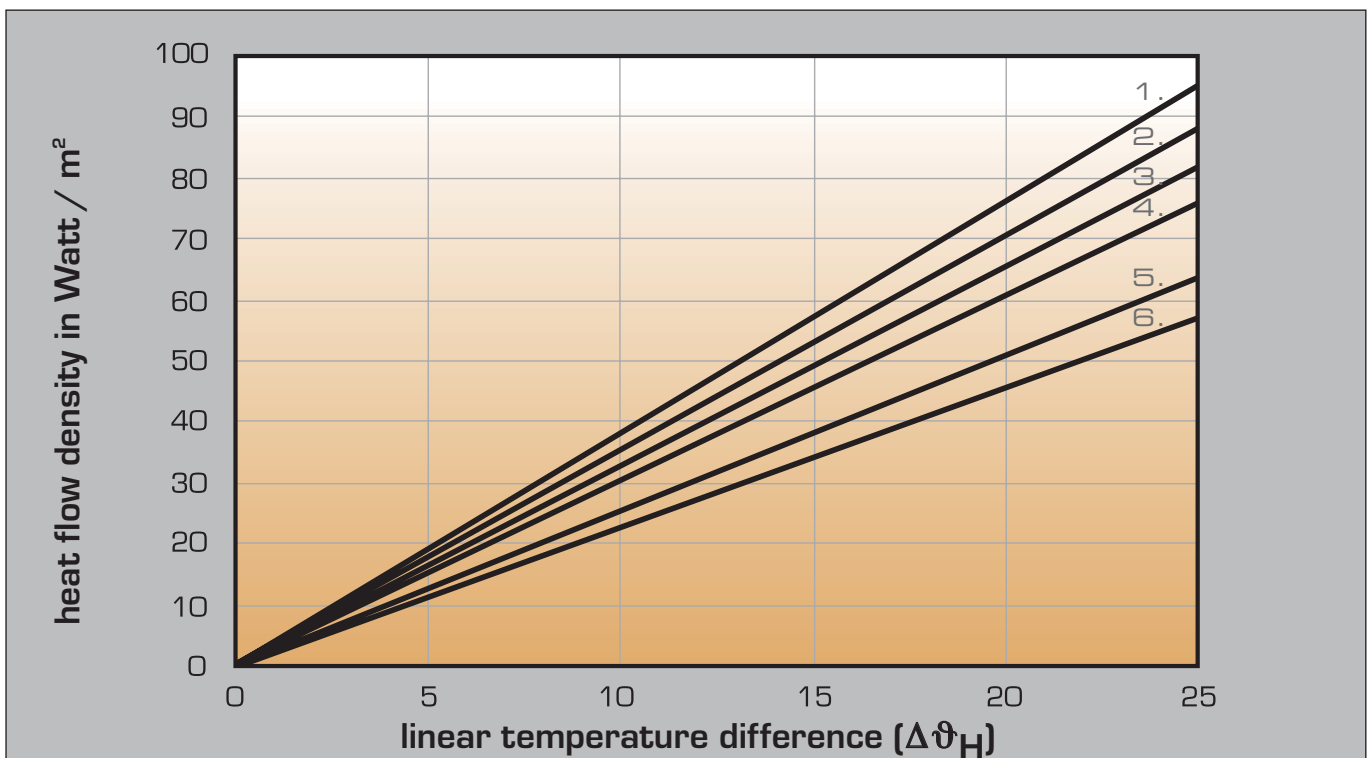

Thermal resistance of surface covering

- ① without surface covering: 0  $\text{m}^2\text{K} / \text{W}$
- ② floor tiles  $\leq 15$  mm: 0.015  $\text{m}^2\text{K} / \text{W}$
- ③ floor tiles  $\leq 25$  mm: 0.03  $\text{m}^2\text{K} / \text{W}$
- ④ parquet 10 mm: 0.05  $\text{m}^2\text{K} / \text{W}$
- ⑤ carpet: 0.1  $\text{m}^2\text{K} / \text{W}$
- ⑥ carpet: 0.15  $\text{m}^2\text{K} / \text{W}$

## Graph of heat output

Graphs of heat output valid for heating pipe 16 x 2 mm with 45 mm screed covering with a pipe spacing PS of 300 mm

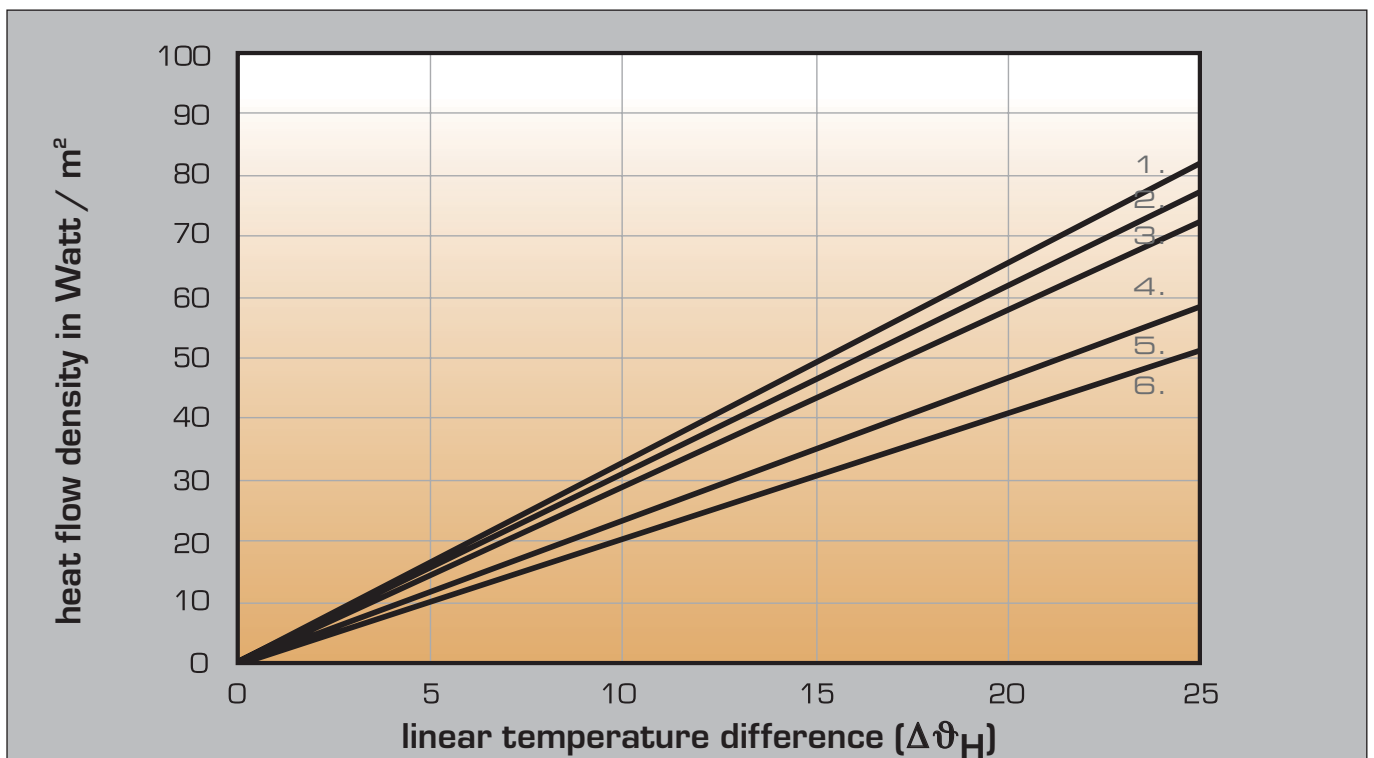

Thermal resistance of surface covering

- ① without surface covering: 0  $\text{m}^2\text{K} / \text{W}$
- ② floor tiles  $\leq 15$  mm: 0.015  $\text{m}^2\text{K} / \text{W}$
- ③ floor tiles  $\leq 25$  mm: 0.03  $\text{m}^2\text{K} / \text{W}$
- ④ parquet 10 mm: 0.05  $\text{m}^2\text{K} / \text{W}$
- ⑤ carpet: 0.1  $\text{m}^2\text{K} / \text{W}$
- ⑥ carpet: 0.15  $\text{m}^2\text{K} / \text{W}$

# Fine control valves

## Presetting of the fine control valves

### Pressure difference

The various heating circuits show different pressure losses due to unequal lengths and utilization. The pressure difference to the heating circuit with the highest pressure loss has to be throttled with the fine control valve.

## Examples:

Pressure loss of the most unfavourable heating circuit:

$$\Delta p_U = 225 \text{ mbar}$$

Pressure loss of the heating circuit to be controlled:

$$\Delta p_{HK} = 50 \text{ mbar}$$

Pressure difference to be throttled:

$$\Delta p = 175 \text{ mbar}$$

Circulating quantity of water:

$$\dot{m}_G = 75 \text{ kg/h}$$

## Pressure loss / mass flow

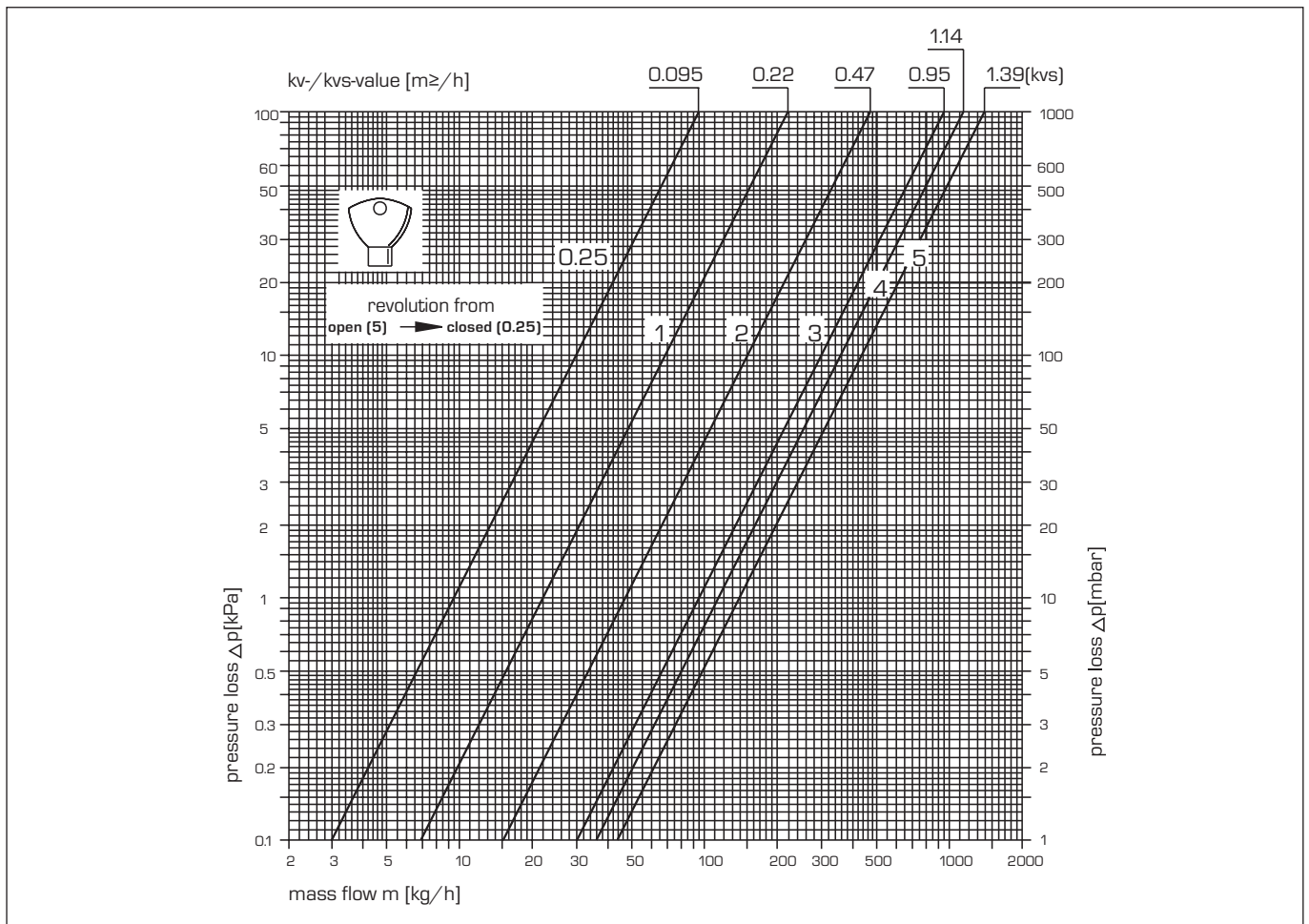

## Membrane expansion vessel

### Membrane expansion vessel

Special care should be taken on designing the membrane expansion vessel for underfloor heating systems. It has to be assumed that even with a "tight" installation leakages exist on a small scale enabling the heating water to evaporate unnoticed.

A pressure expansion vessel which has been correctly designed and integrated into the heating installation fulfils the following functions:

- taking-up of the expansion volume during the heating phase
- storage of a water supply being fed into the system when required e.g. upon cooling or loss due to leakages
- maintaining of a minimum excess pressure in the system (pressure keeping)

The following terms are necessary for a correct dimensioning:

- $n$  = expansion coefficient for water in % (s. table)
- $h$  = static height
- $p_{SV}$  = response pressure of the safety valve
- $\Delta p_A$  = response pressure of the safety valve
- $D_f$  = pressure factor
- $V_H$  = nominal size
- $V_e$  = expansion volume
- $V_A$  = water capacity of the system
- $V_N$  = nominal volume of the expansion vessel
- $V_V$  = water capacity of the system
- $p_a$  = nominal volume of the expansion vessel
- $p_e$  = final pressure in bar absolute
- $\vartheta_V$  = max. flow temperature

### Expansion coefficients for water with and without the addition of antifreezing compounds

Temperature ° C	without addition	10 % addition	20 % addition	30 % addition	40 % addition	50 % addition
10	0.04	0.32	0.64	0.96	1.28	1.60
20	0.18	0.50	0.82	1.14	1.46	1.78
30	0.44	0.76	1.08	1.40	1.72	2.04
40	0.79	1.11	1.43	1.75	2.07	2.39
50	1.21	1.53	1.85	2.17	2.49	2.81
60	1.71	2.03	2.35	2.67	2.99	3.31
70	2.28	2.60	2.92	3.24	3.56	3.88
80	2.90	3.57	3.54	3.86	4.18	4.50
85	3.21	3.57	3.89	4.21	4.53	4.85
90	3.59	3.91	4.23	4.55	4.87	5.19
95	3.96	4.29	4.61	4.93	5.25	5.57
100	4.35	4.67	4.99	5.31	5.63	5.95
105	4.74	5.07	5.33	5.71	6.01	6.35
107	4.91	5.23	5.55	5.87	6.19	6.51
110	5.15	5.47	5.79	6.11	6.43	6.75
120	6.03	6.35	6.67	6.99	7.31	7.63
130	6.97	7.29	7.61	7.93	8.25	8.57

# Types of placing

## Types of placing: spiral type placing

Example of placing A:  
- spiral type placing

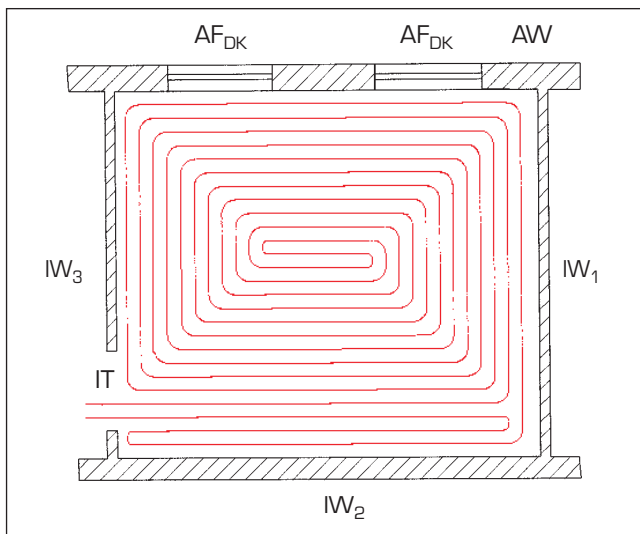

Example of placing B:  
- spiral type placing with separate edge area

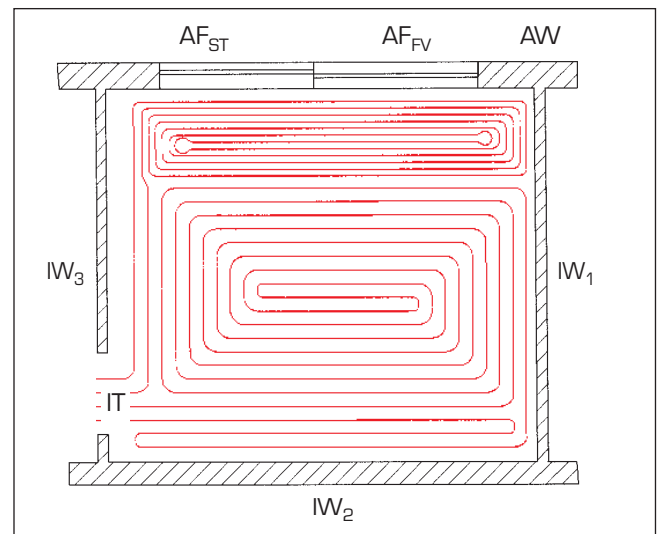

## Types of placing: counterflow-type

Example of placing C:  
- counterflow-type

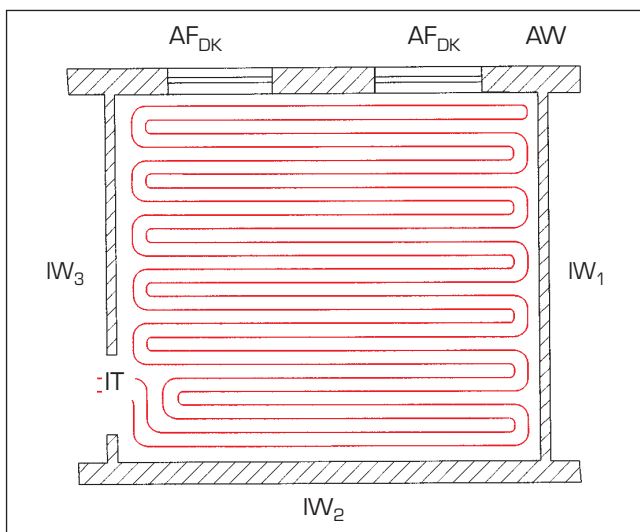

Example of placing D:  
- counterflow-type placing with separate edge area

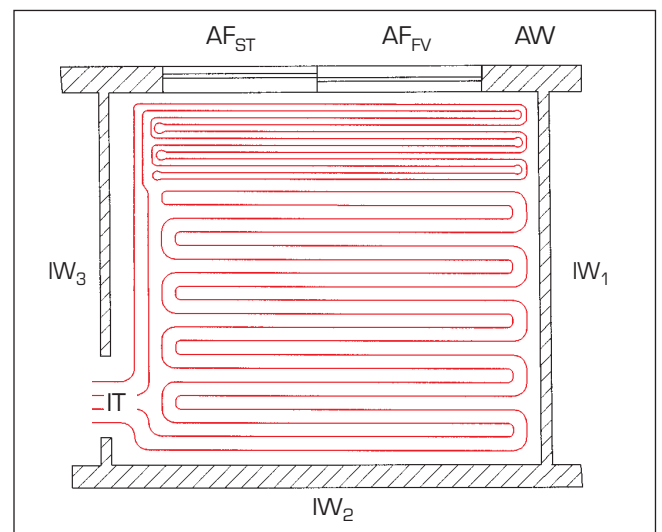

Legend:

- AF<sub>DK</sub> = outside window pivot / tilt design
- AW = outside wall
- IW1 - 3 = inside walls
- IT = inside door

## Example of placing: Pipe spacing

Ground floor

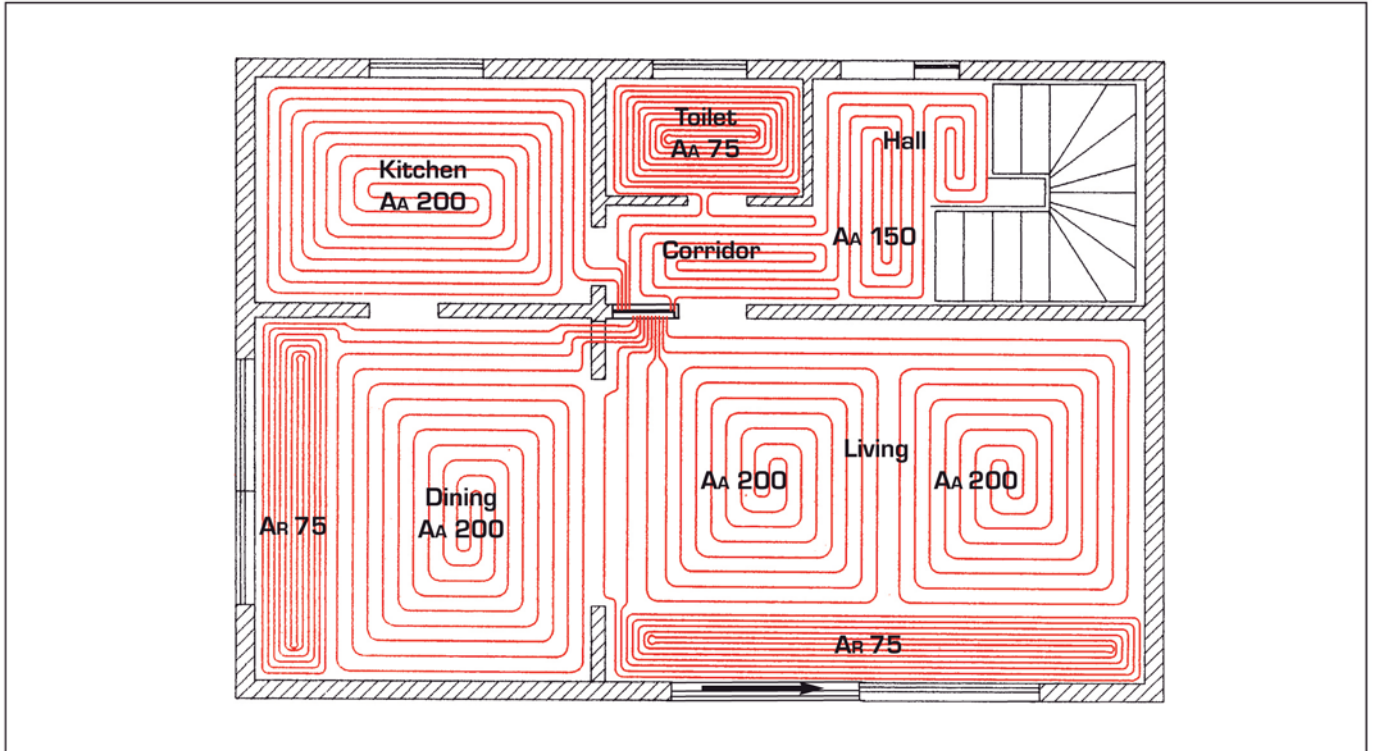

Upper floor

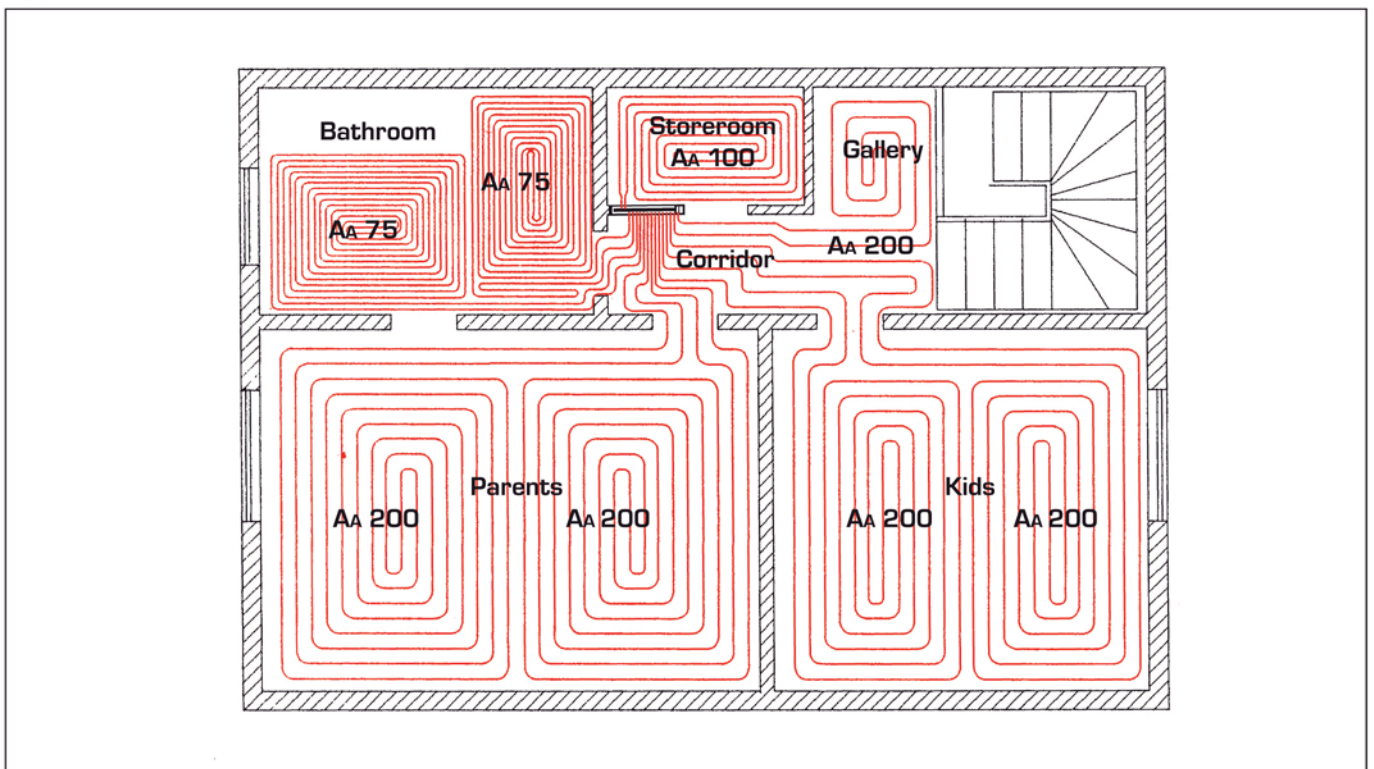

# Planning and design

## Graph of heat output

Heat output of the aquatherm-climasystem  
wall-ceiling heating with pipe grids

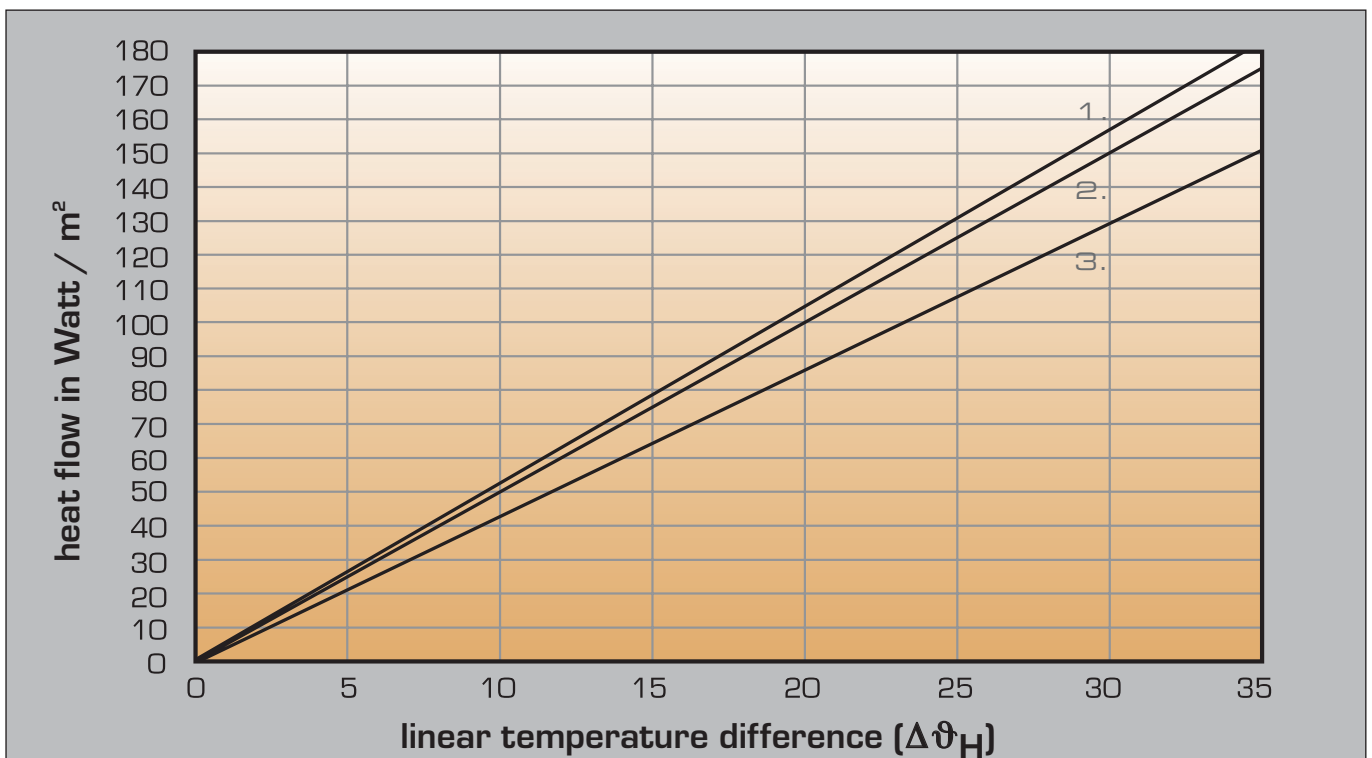

Example of use for the graph of heat outputs

Room:	Office
Room temperature:	$\vartheta_i$ 20° C
Heating load (adjusted):	$\Phi_{Ber}$ 600 Watt
Wall plaster:	$\lambda$ gypsum =0.35 W / mK
Wall covering:	$R_{\lambda B}$ 0.00 m² K / W
Covered wall surface:	m² 15
Heating load per m²:	$\dot{q}$ 40 Watt
Flow temperature:	$\vartheta_V$ 30° C
Return temperature:	$\vartheta_R$ 25° C
Linear temperature difference:	$\Delta\vartheta_H$ 7.5 K
(Difference of room temperature to linear heating temperature)	

$$\left( \frac{\vartheta_V + \vartheta_R}{2} \right) - \vartheta_i = \Delta\vartheta_H$$

- ① plaster
- ② metal
- ③ plaster board

## Planning and design Graph of cooling capacity

Cooling capacity of the aquatherm-pipe grids

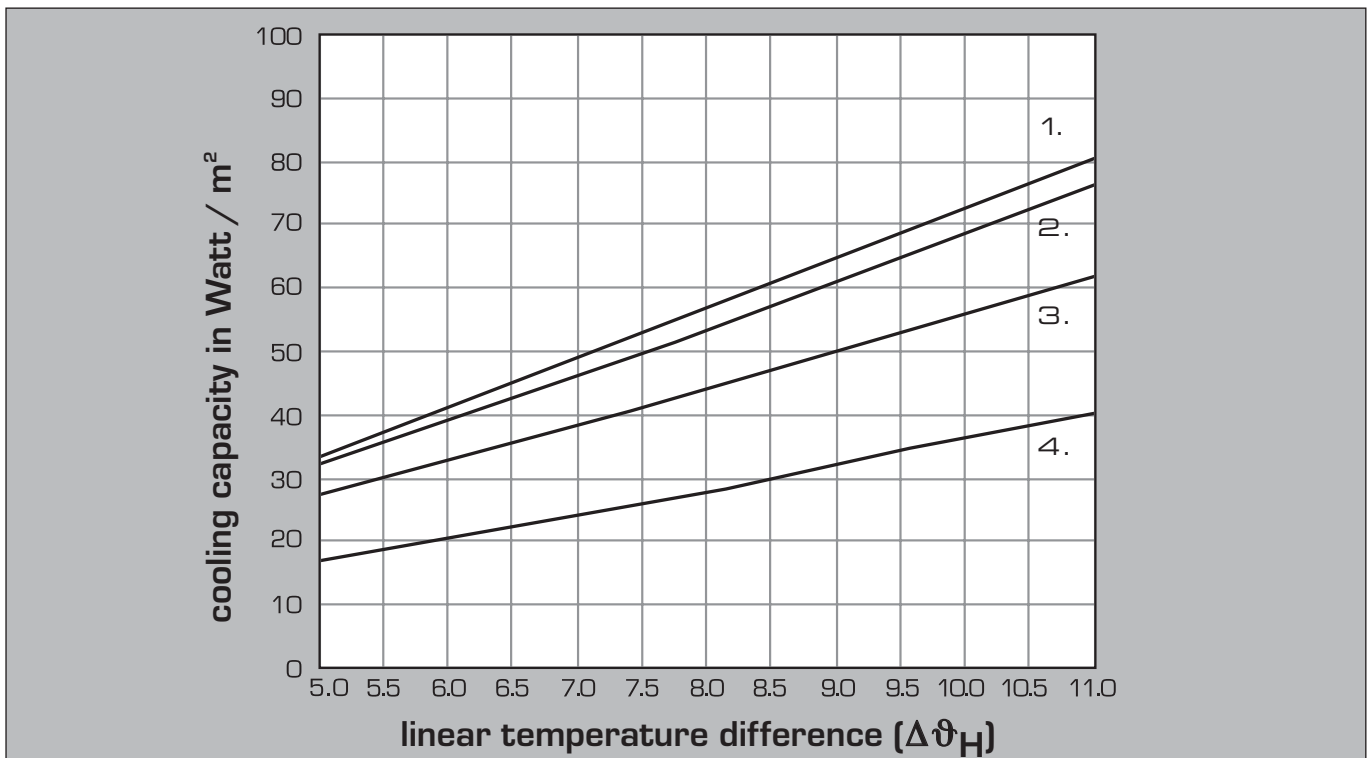

Example of use for the graph of cooling capacity

Room:	Office	
Room temperature:	$\vartheta_i$	27° C
Cooling load:	$\Phi_{Ber}$	900 Watt
Ceiling:	$\lambda$	gypsum plaster = 0.35 W / mK
Covered ceiling surface:	$m^2$	12.5
Cooling capacity per $m^2$ :	$\dot{q}$	72 Watt
Flow temperature:	$\vartheta_V$	16° C
Return temperature:	$\vartheta_R$	18° C
Linear temperature difference:	$\Delta\vartheta_H$	10 K

(Difference of room temperature to linear cooling temperature)

$$\vartheta_i - \left( \frac{\vartheta_V + \vartheta_R}{2} \right) = \Delta\vartheta_H$$

- ① plaster
- ② metal
- ③ plaster board
- ④ mineral



# Planning and Design: Graph of pressure drop

aquatherm-climasystem

Art.-No. 81200 / 81202 / 81105-81450

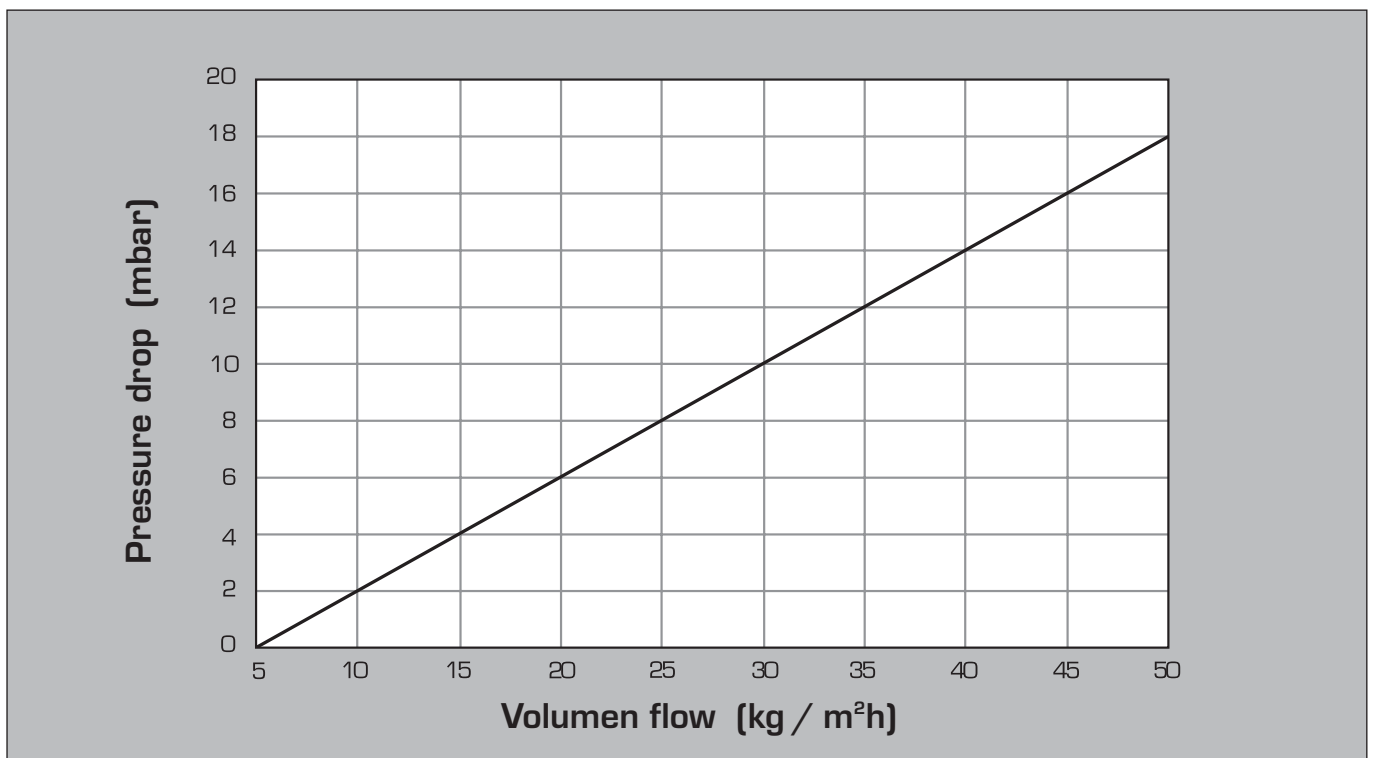

## Planning and design Maximum surface per each cooling circuit

Depending on output, volume flow and temperature difference

### aquatherm-climasystem (Temperature difference 3 K)

Output	Temp. difference	Volume flow	Pressure drop	max. surface per chilling circuit
Watt / m <sup>2</sup>	K	kg / h	mbar / m <sup>2</sup>	m <sup>2</sup>
30	3	8.60	1.50	15.00
35	3	10.03	2.00	15.00
40	3	11.46	2.60	15.00
45	3	12.90	3.20	15.00
50	3	14.33	3.80	14.50
55	3	15.76	4.30	14.00
60	3	17.20	4.90	13.50
65	3	18.63	5.50	13.00
70	3	20.06	6.00	12.50
75	3	21.50	6.60	12.00
80	3	22.93	7.20	11.00
85	3	24.36	7.80	10.50
90	3	25.80	8.20	10.00
95	3	27.23	9.00	9.50
100	3	28.66	9.50	9.00

### aquatherm-climasystem (Temperature difference 2 K)

Output	Temp. difference	Volume flow	Pressure drop	max. surface per chilling circuit
Watt/m <sup>2</sup>	K	kg / h	mbar / m <sup>2</sup>	m <sup>2</sup>
30	2	12.90	3.20	15.00
35	2	15.05	4.00	14.50
40	2	17.20	4.90	13.50
45	2	19.35	5.80	13.00
50	2	21.50	6.60	12.00
55	2	23.65	7.60	11.00
60	2	25.80	8.20	10.00
65	2	27.94	9.10	9.50
70	2	30.09	10.00	9.00
75	2	32.24	11.00	8.50
80	2	34.39	11.80	7.50
85	2	36.54	12.60	7.00
90	2	38.69	13.50	6.50
95	2	40.84	14.30	6.50
100	2	42.99	15.20	6.00

## Laying system element TS 30

The rough concrete has to be stable and sustainable according to DIN 18560.

The tolerances must correspond to the DIN 18202.

For floors in contact with ground a sealing according to DIN 18195 is required.

The aquatherm® edge insulation is laid first. It must be arranged continuously at all rising construction components. The edge insulation is cut after the completion of the surface covering. Additional insulation acc. to ENEV or impact sound insulation have to be installed after arranging of the edge insulation.

The system element TS 30 is placed in such a way that the wall ending is always made with a complete board. Place remaining pieces in the middle of the room wherever applicable!

The heat conducting steel sheets must be pressed into the pipe channels of system element TS 30 after placing. The turning area is omitted. The heat conductivity steel sheets are pre-perforated and thus are easy and simple to arrange.

The heating pipes must be pressed carefully into the heat conductivity steel sheets.

The piping is always made according to the counter-flow principle.

Additionally required pipe channels can be cut with a knife, saw or filament cutter.

Using wet screed the system element TS 30 is covered finally with PE-foil.

The heating circuit manifold should be placed centrally that there is no unnecessary cutting of pipe channels.

DIN 18560 must be observed when constructing with wet screed.

Dry screeds must have a minimum thickness of 25 mm.

For both types of screed the heat-up times acc. to DIN 4725 (EN 1264) must be obtained.



## Laying of system element TS 30

The compact construction provides heights are due to the small board thickness (e.g. 55 mm with dry screed, 60 mm with thin-layer screed, 65 mm with floating screed).

The aquatherm® system element TS 30 is the perfect solution for all situations of laying. Interruptions of the construction progress are avoided.

The small constructions provide best conditions for quick control. Due to the low static weight, e.g. by using dry screed, floating screed or a thin cement layer, the system is especially suitable for wooden beam ceilings.

The installation can be made on existing floor coverings if they are flat and sustainable. The EPS-material is suitable for working loads up to  $7.5 \text{ kN} / \text{m}^2$ , provided that the possibly required additional insulation and the carrying subsoil are adapted to this.

### Example of installation with system element TS 30

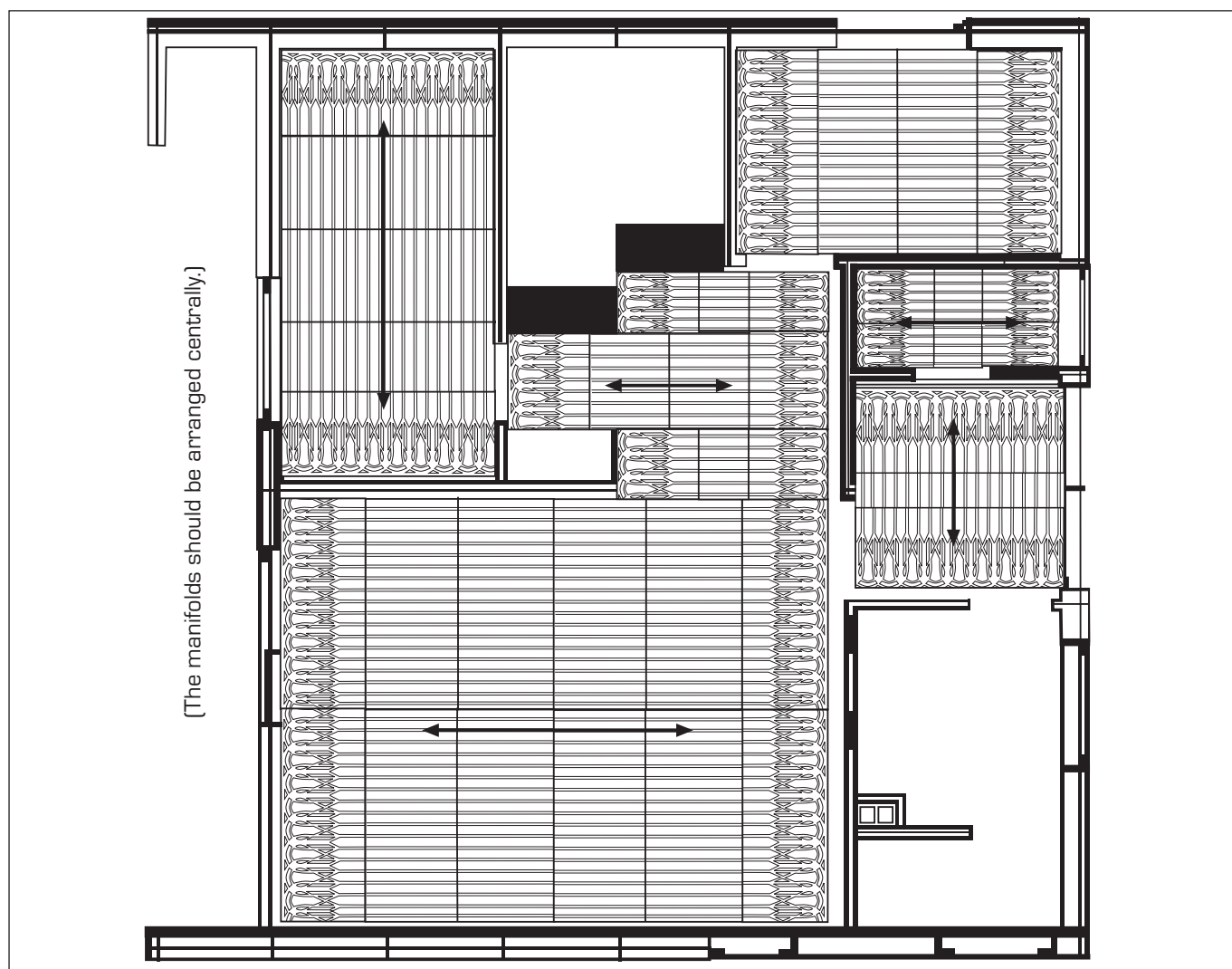

## Graph of heat output System element TS 30

Heat output data system element TS 30 with dry screed 25 mm  
( $\lambda = 0.28 \text{ W / mK}$ )

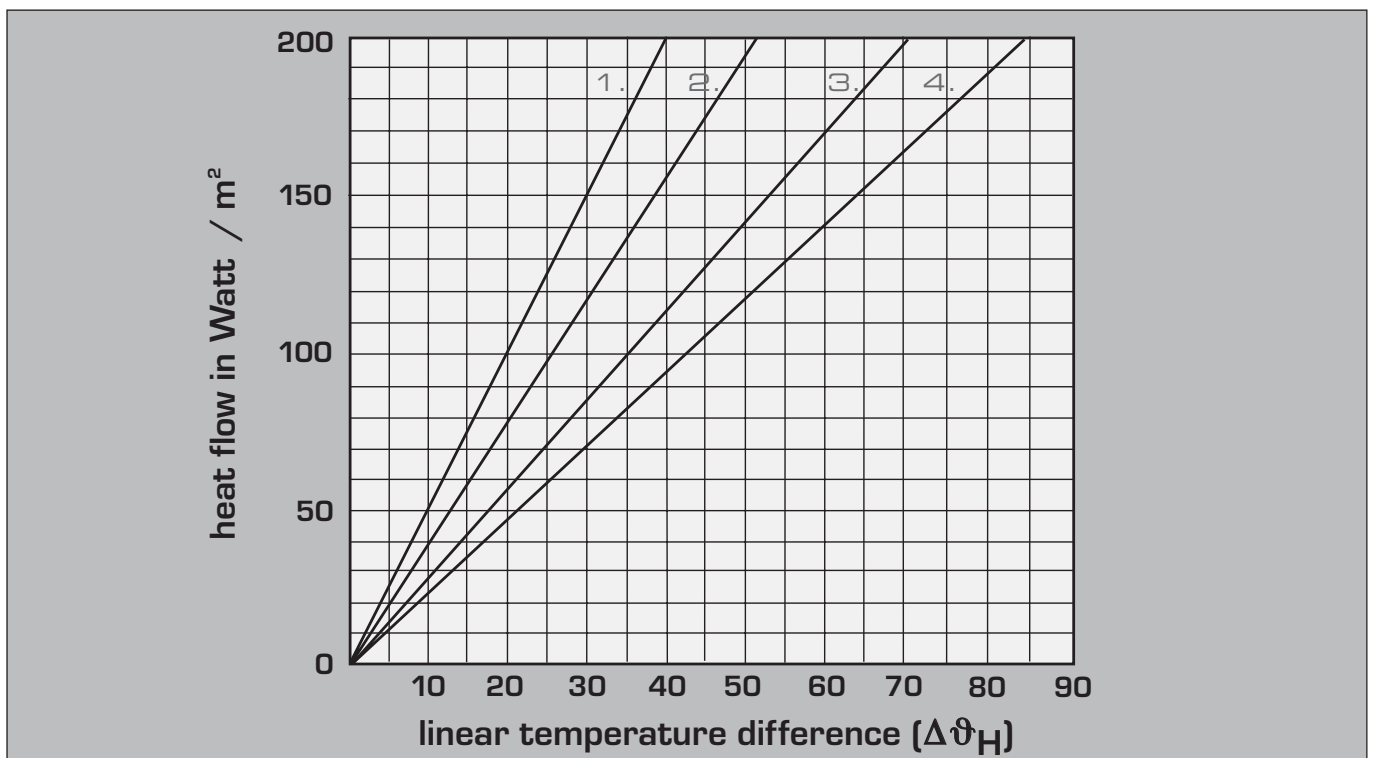

Heat flow  $q$   $\text{W / m}^2$   
for PS 125 dry screed 25 mm

- ① without covering:  $R\lambda B = 0 \text{ m}^2\text{K / W}$
- ② PVC, linoleum:  $R\lambda B = 0.05 \text{ m}^2\text{K / W}$
- ③ carpet:  $R\lambda B = 0.10 \text{ m}^2\text{K / W}$
- ④ carpet:  $R\lambda B = 0.15 \text{ m}^2\text{K / W}$

## Graph of heat output System element TS 30

Heat output data system element TS 30 with cement screed 45 mm  
( $\lambda = 1.2 \text{ W / mK}$ )

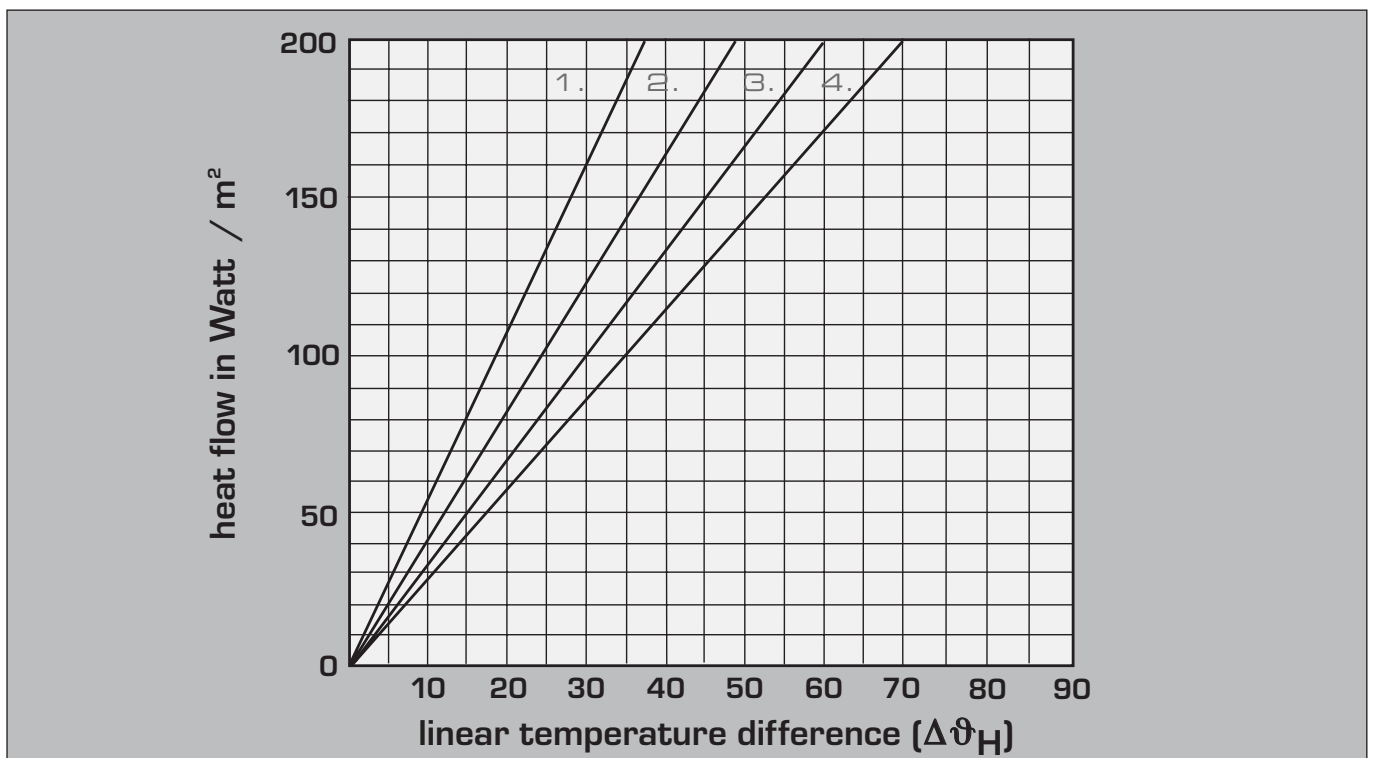

Heat flow  $q$  W / m<sup>2</sup>

for PS 125 cement screed 45 mm

- ① without covering:  $R\lambda B = 0 \text{ m}^2\text{K} / \text{W}$
- ② PVC, linoleum:  $R\lambda B = 0.05 \text{ m}^2\text{K} / \text{W}$
- ③ carpet :  $R\lambda B = 0.10 \text{ m}^2\text{K} / \text{W}$
- ④ carpet:  $R\lambda B = 0.15 \text{ m}^2\text{K} / \text{W}$

## Graph of heat output Industrial floor heating

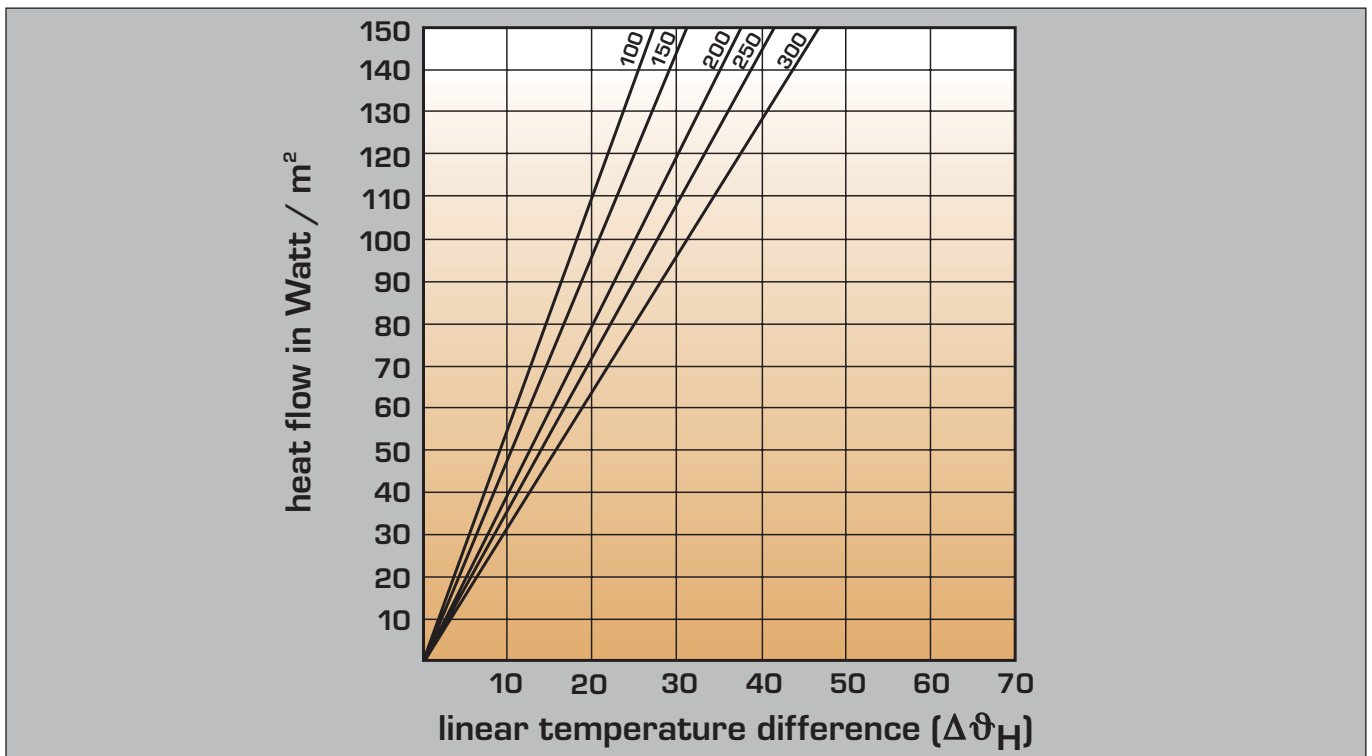

Concrete  $\lambda = 2.10 \text{ W / mK}$   
Covering = 100 mm

# Graph of heat output Industrial floor heating

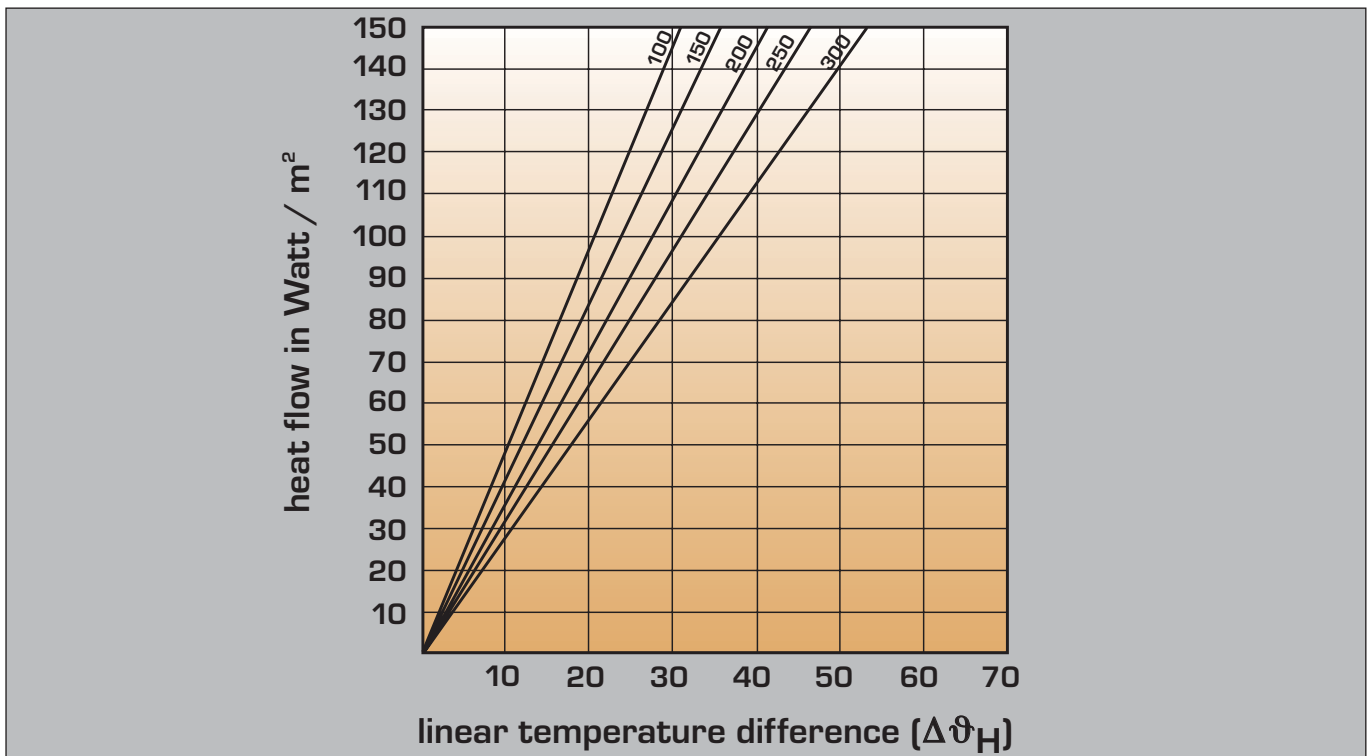

Concrete  $\lambda = 2.10 \text{ W / mK}$   
Covering = 150 mm



## Graph of heat output Industrial floor heating

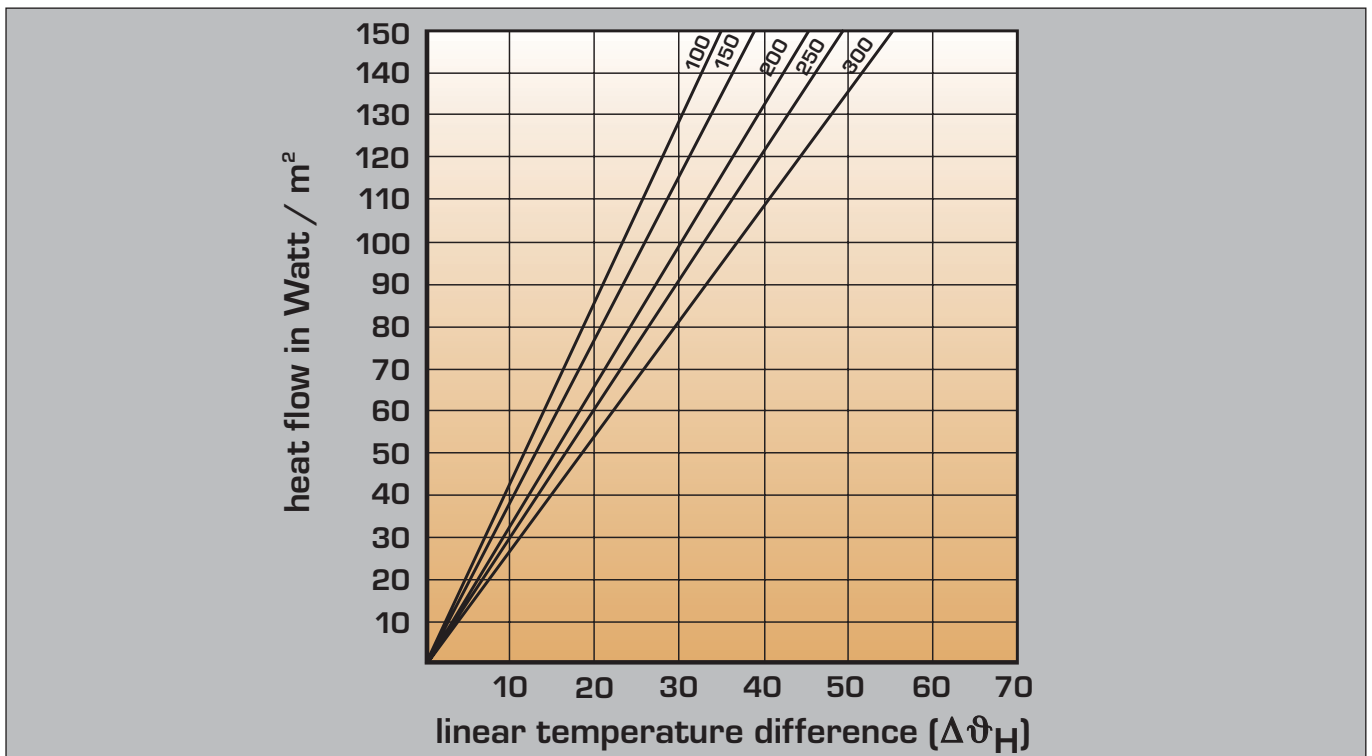

Concrete  $\lambda = 2.10 \text{ W / mK}$   
Covering = 200 mm



# **Chapter 8**

## References

System element TS 30



## Sports floor heating system



Finished sports hall with aquatherm® sports floor heating system with linoleum covering



Tacker technique with pipe clamps



Laying with pipe suspension rail



HARDY's Sportcenter, Munich, Germany

# Sports floor heating system



MAX-FITNESS-CENTER, Attendorn, Germany



MAX-FITNESS-CENTER,  
Installing of sports floor heating system



Sports hall, Lichtringhausen, Attendorn, Germany



Sports hall, Lichtringhausen, Attendorn, Germany

## aquatherm-climasystem



Company Bauer, Wasserburg, Germany



## aquatherm-climasystem



Object Monzanova, Frankfurt, Germany

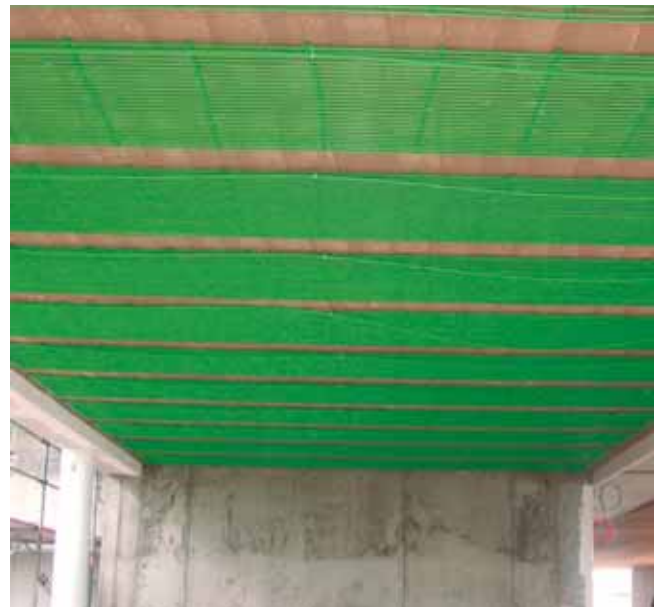
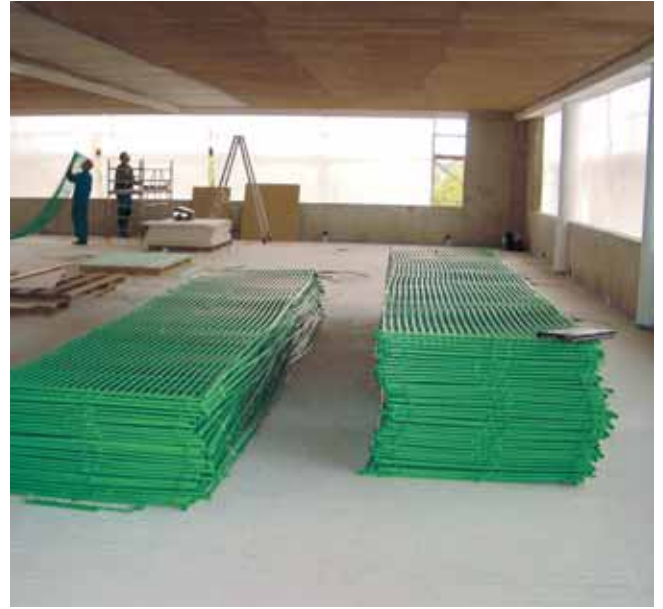

The system must be covered with a plaster layer of approx. 30 - 35 mm. Additional plaster bases are not required when using e.g. Knauf plaster MP 75 G / F or Legito. The instructions of the plaster manufacturer must be obtained.



## Industrial floor heating system



H&R Federn, Lennestadt, Germany



Frey, Car technology, Attendorn, Germany



PUMA Werk, Schlüsselheld, Germany



Company Engel Machinery construction,  
St. Valentin, Austria

# Open space heating system



Open space heating system



Open space heating system

## Under-soil heating system



Under-soil heating system, realized by the climatherm-pipe system in Leipzig's World Cup Central Stadium



Under-soil heating system in Leipzig's World Cup Central Stadium



VELTINS-Arena, Gelsenkirchen, Germany

## Under-soil heating system



Stadium Uherske Hradiste, Czech Republic



Central sports field Reykjavic, Iceland



“Estadio Santiago Bernabéu”, REAL MADRID Spain

# Ice rink cooling system



Ice rink Usti, Czech Republic



Ice rink Moscow, Russia



Ice rink, Passau Germany



Ice rink, Sonneberg, Germany



# Index

## A

accessories-manifold **27, 28**  
 actuator module AB AM 2000 N **46**  
 actuator module AB AM 2000 **54**  
 adapter kit **28, 60**  
 additional heaters **125**  
 additional insulation **68, 90, 179, 180**  
 additional insulation material **90**  
 adhesive layer **14**  
 adhesive tape **79**  
 adjustment **24, 25**  
 adjustment spindle **26**  
 airflow **11, 119**  
 aluminium coating **19**  
 anhydrite **94**  
 anhydrite screed **67, 94, 98, 101, 103, 140**  
 anti-freezer **11, 16, 135, 172**  
 application **11, 71, 87, 150, 152**  
 application **10, 14, 17, 36, 59, 71, 72, 75, 87, 96, 97, 125, 132**  
 ArbStätt **148**  
 armortization **11, 145**  
 automatic switch (analogue) **60**  
 automatic switch (digital) **61**  
 automatic switch (digital) **61**

## B

ball valve **25**  
 ball valve set 1" **24**  
 barrier **14, 15**  
 bases **30, 31**  
 basic load **127**  
 bending radius **16, 18**  
 bending resistance **16, 18, 143**  
 bitumen **65, 94**  
 boiler water **34**  
 boiler circuit **36**  
 brass pipe MS 63 **24, 37**  
 building sealing **64, 65, 68, 133, 140, 141, 142, 143, 144, 148**  
 bypass-function **34, 59**

## C

cable **125**  
 calcium sulphat screed **94**  
 Calculation (heating/cooling) **133, 135**  
 case **32, 34, 43**  
 ceiling plaster **10, 109, 134, 135**  
 cellular glass **145, 148**  
 change in length **14, 99**  
 change in length **14, 99**  
 chemical resistance **14, 20, 111**  
 circuit circulation pump **34**

circulation pump **28**  
 clay plaster **125**  
 climasystem **10, 20, 108-128, 131, 133, 134, 135, 152, 175, 176, 177, 178, 189, 190**  
 climasystem with series connection **25, 109, 113, 114, 115, 117**  
 climate control with change over **132**  
 climatherm **11, 20, 29, 38, 111, 150, 152, 193, 195**  
 closing procedure **43**  
 CM-device **98, 103**  
 coating **19, 72**  
 coating **34, 161**  
 coil **14, 15, 17**  
 combined control **33**  
 combined system **42**  
 concealed installation **29, 30**  
 conditions for placing **102**  
 connecting corrugated pipe **117**  
 connecting supply **34, 157**  
 connecting thread **24, 25**  
 connecting cable **43**  
 connection set with elbow **27**  
 connection supply **17, 87, 92, 100, 145, 157, 160**  
 connection system **44, 45, 46**  
 connection system 230 V **45, 52**  
 connection system AB 2006-N 230 V **45, 46**  
 connection system AB 4001-6 24 V **53, 54**  
 connection system wireless **48, 50**  
 connection system wireless AB 4071-6 **48**  
 connection system wireless AB 4071-12 **49**  
 connection technique **14, 110, 113-118**  
 connection technology **38, 39, 45, 53**  
 connection variations (climasystem) **117**  
 connector **14, 118**  
 construction (under soil heating) **151**  
 construction heights **10, 83, 109, 110, 180**  
 contact thermostate **42**  
 content of humidity **98, 103**  
 contraction **95**  
 control element **43**  
 control methods **127**  
 control methods "combination of parallel and serial connected surfaces" **130**  
 control methods "connection of smaller heating surfaces" **131**  
 control methods "parallel connection" **128**

control methods "serial connection" **129**  
 control module AB RM 2000 N **46**  
 control module AB RM 4000 **54**  
 control technique **10, 41-61, 110, 127**  
 control unit analogue **60**  
 cool down **43**  
 cooling industry **20, 111**  
 cooling load **176**  
 cooling operation **10, 108, 132**  
 corrosion inhibitors **14**  
 corrosion resistance **14**  
 counter flow principle **150, 173, 179**  
 C-profile **30, 31**  
 creep strength **14, 17**

## D

daily program disc **44**  
 datanorm-files **7**  
 delay time **43**  
 delays **42**  
 density **19, 95, 96, 145**  
 designation **15, 17, 19, 20**  
 dew point **132**  
 differential pressure overflow valve **59, 60, 61**  
 digital clock **45, 53**  
 DIN-certco-registration **14, 17, 162**  
 DIN-regulations **64, 67**  
 distribution **24, 25**  
 double pipe arrangement **132**  
 double swing floor **39, 141**  
 draught **110**  
 draught **10, 65, 103, 108, 127, 148**  
 dry construction **10**  
 dry construction **126**  
 dry screed **10, 71, 87, 179, 180, 181**  
 dry-lined panels **8, 10, 109**  
 drylined wall **108, 126**  
 dust dispersing **11**  
 dust reduction **110**

## E

edge gaps **99**  
 edge insulation **68, 69, 91, 99, 101, 140, 160, 179**  
 elastic modulus **16, 18**  
 elastic spring pads **141, 142**  
 electrical connection **43**  
 electronic ray cross linked polyethylene **19**  
 element for hydraulical balancing **36**  
 embedding **10, 14, 95**  
 EN 1264-4 **64, 66, 67, 133**

energy loss **11, 150**  
 energy saving decree **145, 156**  
 energy saving regulation **42, 64, 66, 90, 127, 133, 140, 141, 142, 145, 156, 179**  
 Estro-syntetic fibres **95, 97**  
 euroconus adapter **19**  
 Euroconus connector **24, 27, 37**  
 EVOH - coating **14, 15**  
 example of laying **174, 179, 170**  
 exchange **26, 69, 70**  
 exhibition **7**  
 expansion coefficient **172**  
 expansion joint **92, 99, 101, 102**  
 expansion joint profile **92, 93, 100**  
 expansion strip (PE) **93, 100**  
 expansion system **43**  
 expansion volume **172**  
 extension module **45, 46, 48, 49, 53, 54, 56**  
 external control **14**  
 extreme temperature stability **20, 111**  
 extreme temperature stability **20, 111**  
 extrusion foam **145**  
 extrusion procedure **14**

## F

factor of floor covering **161**  
 factory fresh mortar **97**  
 faser composite pipe **11, 150**  
 feed valve **24**  
 Fermacel screed comb **71**  
 ferroconcrete **96, 146, 148**  
 field staff **7**  
 fields of application **11, 152**  
 fine control valve **171**  
 first-open function **43**  
 fixing distances **67**  
 fixing set **25**  
 flatness tolerance **65, 119, 179**  
 flexibility **14, 15, 17**  
 floor coverings **64, 69, 70, 71, 91, 97, 98, 99, 100, 101, 102, 103, 146, 157, 159, 161, 162, 164-170, 180**  
 floor coverings (industrial floor heating) **146**  
 floor lining **30, 31**  
 floor plan **10**  
 floor surface coverings **159**  
 flow **34**  
 flow temperatures **11, 20, 33, 34, 36, 59, 61, 102, 103, 111, 119, 132, 161**  
 flow temperture **162**  
 flow thermometer **59**  
 follow-up time **47, 50, 55**  
 friction loss **14**



functional efficiency **10, 14**  
 functional heating (climasystem)  
**104, 135**  
 fusiofen® PP-R (80) **5, 20, 111**  
 fusion welding **10, 109**  
 fusion welding **11, 150, 152**  
 fusiotherm® **6, 11, 38, 39, 150, 152**

## G

graph of cooling capacity  
 (climasystem) **176**  
 graph of heat output (climasystem)  
**175**  
 graph of heat output industrial sur-  
 face heating **182**  
 graph of pressure loss **157, 163**  
 graphs **133**  
 gravity brake **42**  
 grid foil **75**  
 ground **11, 64, 65, 90, 145, 149,**  
**150, 179**  
 group setback **44**  
 gypsum board finishes **109, 133**

## H

hand wheel **34, 36**  
 health **122, 124**  
 heat accumulation capability **95**  
 heat conducting lamellas **143, 144**  
 heat conducting steel sheets **87,**  
**179**  
 heat demand **59, 157, 162**  
 heat exchanger **14**  
 heat loss **11, 125, 150, 158**  
 heat output **80, 83, 125, 148, 161**  
 heat output data system element  
 3D **181**  
 heat radiation **119**  
 heat stability **14, 17, 102**  
 heating load **71, 133**  
 heating operation **43, 132**  
 heating pipe (PB) **17, 18**  
 heating pipe (PE-RT) **15, 16**  
 heating water additions **14**  
 heating water circulation **10, 109**  
 heating/cooling module AB HK  
 4000 **56**  
 heating-up (screed) **103, 135**  
 heating-up time **114, 179**  
 holding element **117, 118**  
 hydraulic balancing **39, 149, 160**

## I

ice free surface **149**  
 ice surface cooling **152, 197**  
 impact rate **14, 16**  
 impact sound insulation **65, 69, 70,**  
**71, 80, 88, 89, 100, 179**

impact sound insulation **69**  
 improvement of impact sound  
 insulation **69, 71**  
 individual room control **10, 36, 42,**  
**53, 65, 108, 127, 132**  
 industrial surface heating **11, 145,**  
**146, 148**  
 injection mixing valve **33**  
 injection valve **34**  
 installation **11, 25, 32, 33, 35, 43,**  
**67, 70, 96, 97, 101, 110, 150,**  
**179, 180**  
 installation conditionsem **65**  
 installation depth **25**  
 insulation layer **91**  
 insulation requirements **66, 90, 91,**  
**145**  
 insulation shell **61**  
 internal control **14**

## J

joint arrangement **146**  
 joint gaps **79**

## K

knob plate F ND 1183, **84, 85, 86**  
 knob plate F NE 35-3 **80, 81, 82**

## L

laboratory **7**  
 laying situation **10, 180**  
 laying system element TS 3D **179,**  
**180**  
 Lazenoflex-underfloor heating  
 system **83**  
 leak test **104**  
 leakage **172**  
 length of circuit **160**  
 levelling layer **143, 144**  
 lime cement plaster **125**  
 liNear **7**  
 linear expansion **14, 125**  
 lining **75**  
 lining block **141, 142**  
 liquid screed (CA + CAF) **94**  
 long-term temperatures **20, 102,**  
**111**  
 lowering time **42**

## M

male thread **24, 25, 117**  
 manifold cabinet (concealed) **29,**  
**30, 32**  
 manifold cabinet  
 (surface installation) **32**  
 manifold cabinet (surface) **32**  
 manifold connection area **160**

manifold connection pipes **11, 150,**  
**152**  
 manifold for wide surfaces **37**  
 manifold holding device **31**  
 manifold pipes **11, 38, 39, 150,**  
**152**  
 manifold with flow meter **24**  
 manifold without flow meter **25**  
 manual adjustment cap **24, 26, 28**  
 manual construction protection **26**  
 marking plates **26**  
 mass flow **26, 171, 178**  
 material **14, 15, 17, 20, 111**  
 material requirements **160**  
 material stressing **10, 111**  
 maximum temperature limiter **61**  
 minimum heat protection **64, 66,**  
**90**  
 minimum thermal resistance **90**  
 mixer motor **42, 60**  
 mixing control **36, 59**  
 mixing loop **42**  
 moisture content equilibrium **102,**  
**103**  
 mounting rail **109, 116, 134**  
 movement joints **100, 125**  
 multi-layer metall composite pipe  
**10, 19**

## N

new building **10, 48, 150**  
 night setback **42**  
 noise interference **10, 108**  
 nominal size **172**  
 nominal volume **172**

## O

occupied zone **157, 158**  
 old building **10, 87, 127**  
 open space heating **11, 149, 192**  
 opening course **43**  
 O-ring sealing **26, 177**  
 outlets **152**  
 outside sensor **60, 61**  
 overload protection **45, 51, 53**  
 overvoltage protection **45, 51, 53**  
 oxygen tight coating **14**  
 oxygen tightness **14, 20, 116**

## P

packing **14, 26**  
 PE-foil **68, 91, 179**  
 perimeter zones **157, 158**  
 pilote stream **34**  
 pipe **117, 125, 133, 148, 156**  
 pipe channels **10, 87, 179**  
 pipe clamps **62, 72, 75, 78, 140,**  
**141**  
 pipe connection **14**  
 pipe couplings **67**  
 pipe grid **10, 108, 109, 175, 176**  
 pipe hasp **14**  
 pipe holding knobs **80, 83**  
 pipe inner surface **14**  
 pipe lay out **38, 39**  
 pipe lay out (reverse return  
 technique) **38, 39**  
 pipe material **16**  
 pipe spacing **38, 39, 148, 150,**  
**158, 164-170, 174**  
 pipework **11, 150, 152**  
 placing of rails (under soil heating)  
**150**  
 plaster reinforcing **125**  
 polybutylene (PB) **17, 18**  
 polyethylene (PE-RT) **15, 16, 19**  
 polyethylene foam **71**  
 polypropylene PP-R(80) **6**  
 polystyrene HR foam EPS 035 DEO  
 (PS30SE) **71, 87**  
 polystyrene HR foam EPS 200 **83**  
 polystyrene insulation roll **72**  
 position indicator **43**  
 poured asphalt screed **94**  
 power reserve **60**  
 PP-grid pipe **10, 20**  
 pre-control **42**  
 predetermined breaking point **100**  
 preliminary tempering **14**  
 pressure charge **20, 111**  
 pressure difference **170**  
 pressure expansion vessel **172**  
 pressure loss **39, 42, 109, 157,**  
**160, 171, 177, 178**  
 pressure stress **95, 96, 145**  
 pressure test (climasystem) **135**  
 principle heating/cooling  
 (wall & ceiling) **120, 132**  
 process control **7, 14**  
 profile rail **75, 79, 147**  
 profile rail **93**  
 programmable analogue  
 room thermostat **44, 45, 58**  
 program selection switch **60**  
 PS 100 **158, 166**  
 PS 150 **158, 167**  
 PS 200 **158, 168**  
 PS 300 **158, 170**  
 PS 50 **158, 164**  
 PS 75 **158, 165**  
 pull in installation principle  
 (under soil heating) **150**  
 pump module **33, 35, 36**  
 pump module AB PL 2000 N **47**  
 pump module AB PL 4000 N **50,**  
**55**  
 PUR HR foam board **65**  
 push-fit coupling **10, 109**  
 PWW-heating system **36**

## Q

## R

radiator connections **15, 17**  
 radiator system **33, 59**  
 rated break points **79**  
 reconstruction **10, 83, 87**  
 refurbishment **10**  
 Regulation for heating systems **36, 42, 148**  
 regulations for design **148**  
 rejected heat **11, 119**  
 remaining bundles **14**  
 requirement profile **14**  
 requirements (subsoil) **65, 119**  
 requirements industrial surfaces **148**  
 resistance **20, 111**  
 return control valve **26**  
 return valve **24, 25, 26, 37**  
 reverse return (Tichelmann-technik) **38, 39, 149**  
 rigidity class ZE 30 **96, 97**  
 riser **33**  
 rolled concrete **146**  
 room air **10, 11, 108, 119, 122, 124**  
 room air **10, 108**  
 room thermostate **36, 43, 44, 45, 51, 56, 127**  
 room thermostate heating/cooling AR 4010 K **56**  
 room thermostate NRT 210 **52**  
 room thermostate NRT 220 **52**  
 room thermostate wireless AR-4070 KF **50**  
 rough cement floor **65, 69, 143, 144**  
 rugs **159**

## S

safety temperature limiter **33, 36, 59, 60**  
 scale ring **38**  
 screed **14, 91, 95, 96, 97, 100, 101**  
 screed additive **94, 95**  
 screed additive "Special" **94, 96, 97**  
 screed fields **99, 100**  
 screed measuring point **98, 103**  
 screed reinforcement **97, 101**  
 screeds **94, 95, 96, 98, 101, 103, 148, 161, 178**  
 screw connections for manifolds **14**  
 set key button **48, 50**  
 set value control **36**

shell phase **43**  
 SHT-connection technique **15, 17**  
 SHT-transition adapter **38, 39**  
 SHT-sliding sleeve technique **38, 39, 113**  
 snap-on installation **43**  
 snow free surface **11, 150**  
 software-service **7**  
 sound insulation **64, 69, 70, 133, 156**  
 sound of flow **14**  
 spiral type placing **173**  
 sports floor (combined flexible) **144, 162**  
 sports floor (spot flexible) **140, 144**  
 sports floor double swing floor (surface flexible) **141, 143, 144, 162**  
 square pipes **109**  
 square spanner **24, 25**  
 standard foot fall sound level **69, 70**  
 standard heating load **133, 148, 156, 157**  
 standard values for surface coverings **159**  
 standards and guidelines (heating/cooling) **133**  
 starting **10, 13, 135**  
 steel fibre concrete **146**  
 stopvalve **24, 25, 37**  
 stop valve Quickstop **24**  
 surface considerations **11, 125**  
 surface finishes **125**  
 surface heating system **14, 25, 42**  
 surface temperatures **59, 110, 125, 157, 158, 160, 162**  
 surplus pipes **15, 17**  
 swing bearer **141**  
 switch combination **44**  
 switching to summertime **47, 55**  
 switching to wintertime **47, 55**  
 symbols (underfloor heating) **159**  
 system element knob plate **68, 70, 80-81**  
 system element TS 30 **10, 87, 88, 89**  
 system element valufix-roll 35-3 **72, 73, 74**  
 system technology **20, 42, 111**

## T

tacker technique **72, 79, 141, 187**  
 Tackfix-tacker **78, 141**  
 temperature profile **11**  
 temperature protection **42**  
 temperature stability **20, 111**  
 tensile strength **146**  
 tensions **14, 100**  
 test report **135**  
 thermal conductivity **34, 94, 95,**

**96, 125, 133**  
 thermal distribution layer **125**  
 thermal feedback **44**  
 thermal insulation **11, 31, 75, 83, 140-142, 145, 150**  
 thermal insulation duty **145**  
 thermal output **11, 157**  
 thermal protection **42, 64, 66, 133, 145, 148, 156**  
 thermal resistance **102, 125, 159**  
 thermometer **33, 34**  
 thermostat **34**  
 thick mortar bed technique **101**  
 thin bed mortar **102**  
 thin mortar bed technique **101**  
 three-way mixer **60, 61**  
 tightness **14, 67, 135**  
 timermodule AB TM 1000 N **47, 55**  
 timerthermostat **45**  
 top hat rail **30, 45, 46, 53, 54**  
 T-profile **100, 109**  
 training **7**  
 tubular feed through **30, 31**  
 types of laying **72, 107, 173**

## U

under soil heating **11**  
 universal flow meter **28**  
 upper part of thermostat **24**  
 U-value **66**

## V

vacuum concrete **146**  
 valutherm-aluminium grid foil **10, 75, 76, 77**  
 valve insert **25**  
 VDI 2078 **133**  
 ventilation valve **24, 25**  
 visual performance ceiling cooling **122**  
 visual performance ceiling heating **121**  
 visual performance wall cooling **124**  
 visual performance wall heating **123**  
 VOB contract procedure for building works **64**  
 volume adjustment **24, 25, 26, 37**  
 volume flow **24**  
 volume flow **24, 25**  
 volume flow control **37**  
 volume flow meter **24, 26**

## W

wall brackets **134**  
 wall grid installation **136**  
 wall heating zone **128, 129, 130**  
 wall plaster **133**

water pressure test **67**  
 water separation **95**  
 water volume calculation **42, 157**  
 weekly program disc **44**  
 weld-in saddle **38, 39**  
 weld-in saddle technique **11, 38, 39, 150, 152**  
 welding connection **117**  
 welding devices **114**  
 wet construction **10**  
 wet construction **87, 126, 133, 136**  
 wet laying **14**  
 window placing **11, 158**

## X

## Y

## Z

zone control **58**



---

---

---

---

---

---

---

---

---

---

---

---

---

---

---

---

---

---

---

---

---

---

---

---

---

---

---

---

---

---





---

**Our general conditions of sale and delivery (Date: January 2005)**

**These are printed completely on our homepage [www.aquatherm.de](http://www.aquatherm.de)  
or we will send them to you on demand!**

Subject to technical changes.

---







## **aquatherm GmbH**

Biggen 5  
D-57439 Attendorn  
Telefon: 02722 950-0  
Fax: 02722 950-100

Wilhelm-Rönsch-Str. 4  
D-01454 Radeberg  
Telefon: 03528 4362-0  
Fax: 03528 4362-30

E-mail: [info@aquatherm.de](mailto:info@aquatherm.de)  
[www.aquatherm.de](http://www.aquatherm.de)



# **aquatherm**

